

# SOUTHWEST HOUSING TRADITIONS

DESIGN MATERIALS PERFORMANCE





PATH (Partnership for Advancing Technology in Housing) is a private/public effort to develop, demonstrate, and gain widespread market acceptance for the next generation of American housing. Through the use of new or innovative technologies the goal of PATH is to improve the quality, durability, environmental efficiency, and affordability of tomorrow's homes.

PATH is managed and supported by the U.S. Department of Housing and Urban Development (HUD). In addition, all Federal agencies that engage in housing research and technology development are PATH partners including the Departments of Energy and Commerce, as well as the Environmental Protection Agency (EPA) and Federal Emergency Management Agency (FEMA). State and local governments and other participants from the public sector are also partners in PATH. Product manufacturers, home builders, insurance companies, and lenders represent private industry in the PATH partnership.

**To learn more about PATH, please contact:**

PATH  
Suite 8134  
451 Seventh Street, SW  
Washington, DC 20410  
202-708-4250 (fax)  
**pathnet@pathnet.org**

Visit PD&R's web site at **[www.huduser.org](http://www.huduser.org)** to find this report and others sponsored by HUD's Office of Policy Development and Research (PD&R). Other services of HUD USER, PD&R's Research and Information Service, include listservs; special interest, bi-monthly publications (best practices, significant studies from other sources); access to public use databases; hotline 1-800-245-2691 for help accessing the information you need.

**disclaimer**

This report was prepared by Vint and Associates Architects Inc. for the U.S. Department of Housing and Urban Development, Office of Policy Development and Research. The contents of the report are the responsibility of the contractor and do not necessarily reflect the views or policies of the U.S. Department of Housing and Urban Development, the U.S. Government, or any other person or organization.

*front cover illustration:*

*Empire Ranch Headquarters, Arizona, 1880*

*Photo courtesy of Laura Vail Ingram, Empire Ranch Foundation*

*back cover illustration:*

*Acoma Pueblo, New Mexico, 1930.*

*Photo by A. C. Vroman by permission of California Museum of Photography*

may 2005

# SOUTHWEST HOUSING TRADITIONS

## DESIGN MATERIALS PERFORMANCE

PREPARED FOR:

U.S. Department of Housing and Urban Development  
Office of Policy Development and Research  
Contract #: S2C5ANC0074

PREPARED BY:

Bob Vint & Christina Neumann  
**VINT & ASSOCIATES, ARCHITECTS INC.**

## PROJECT TEAM

### VINT & ASSOCIATES, ARCHITECTS INC.

#### Bob Vint, Architect

*Principal author, architectural designer, and project director.  
Tucson, AZ*

#### Christina Neumann, LEED™ A.P.

*Leadership in Energy & Environmental Design  
Accredited Professional, U.S. Green Building Council  
Researcher and contributing writer.  
Tucson, AZ*

#### John Messina, AIA

*Contributing writer and research architect, The Southwest Center  
University of Arizona, Tucson*

#### Nader Chalfoun, Ph.D.

*Consultant for energy modeling.  
Professor of Architecture University of Arizona, Tucson*

U.S. Department of Housing & Urban Development  
Office of Policy Development and Research

#### David Engel, Director

*Division of Affordable Housing & Technology  
US Department of HUD*

#### Luis F. Borray, Research Architect

*Division of Affordable Housing & Technology  
US Department of HUD*

### DESIGN & GRAPHICS

#### Anne Briggs

*Graphic Design*

#### Paul Briggs

*Drafting and layout  
Associate Architect, Vint & Associates*

#### Christina Neumann

*Graphic Design  
Associate Architect, Vint & Associates*

## ACKNOWLEDGMENTS

*Vint & Associates Architects wish to acknowledge the following individuals & organizations who through their support and collaboration made significant contributions to the completion of this Study.*

#### Quentin Branch

*Rammed Earth Solar Homes Tucson, AZ*

#### Dr. Owen Geiger

*Director, Builders Without Borders Kingston, NM  
Mentor, United Nations Institute for Training and Research*

#### Mary C. Hardin, AIA

*Associate Professor of Architecture,  
College of Architecture & Landscape Architecture  
University of Arizona, Tucson*

#### Caroline Roberts

*Author, A House of Straw: a Natural Building Odyssey*

#### Catherine Wanek

*Administrative Coordinator  
Builders Without Borders Kingston, New Mexico*

#### Joseph C. Wilder, Ph.D.

*Director, The Southwest Center  
College of Social and Behavioral Sciences  
University of Arizona, Tucson*

#### Judy Knox & Matts Myhrman

*Out On Bale, (un)Ltd*

#### Alfred von Bachmayr

*Project Founder and Director  
The World Hands Project*

#### Katia Lemone

*Director, The Kutunza Institute*

#### Eric J. Means

*Means Design & Building Corp.*

#### Steven Hess, P.E.

*Hess Structural Engineering Tucson, AZ*

#### Radhika Murthy

*Graduate Student  
College of Architecture & Landscape Architecture  
University of Arizona, Tucson*

#### Ralph M. Pattison, P.E.

*Pattison Evanoff Engineering Tucson, AZ  
Geotechnical Engineering & Materials Testing*



## FOREWORD

The United States Department of Housing and Urban Development is committed to meeting the unique housing needs of the citizens of the “colonias,” those rural communities and neighborhoods located close to the U.S.-Mexico border that lack adequate infrastructure and other basic services. A growing population, mostly of newer immigrants, places enormous housing pressures on local governments, the nonprofit community, and the marketplace to provide safe, sanitary housing to lower income residents in these areas.

As attention and public investment in these areas grows, increased attention is being paid to the special climatic and cultural needs found in the Southwest. An area of climatic and cultural extremes, historically the Southwest had developed an architectural style that utilized building materials used nowhere else in the nation. In recent decades, these designs and materials have been increasingly forgotten or ignored.

This major new publication, *Southwest Housing Traditions*, reexamines traditional southwestern designs and materials within the context of the Twenty-first Century housing needs and assesses their relevance today. The author finds that not only are such materials generally cost-competitive with more widely accepted construction techniques, but can also offer unique benefits in resource management and energy efficiency.

Although primarily written for nonprofit providers of low-income housing, I believe this publication will also be an important tool for local governments and private builders that are meeting more general housing needs.

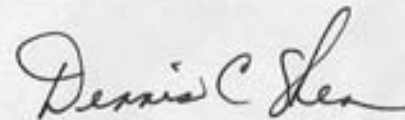

Dennis C. Shea  
Assistant Secretary  
for Policy Development and Research



Acknowledgments  
Foreword

**PREFACE**

---

chapter 1    **PROBLEMS & SOLUTIONS**    **11**

---

chapter 2    **DESIGN**    **39**

---

URBAN EXAMPLES

Casa Grande    41  
Acoma Pueblo    45  
Row house    49  
Zaguán house    53  
Courtyard house    57  
Cellular house    61  
Hybrid House    65

RURAL EXAMPLES

Empire Ranch    69  
Gray Ranch    73  
Bungalow    77

---

chapter 3    **MATERIALS**    **81**

---

WALLS

Adobe    83  
Rammed Earth    91  
Straw Bale    97

FOUNDATIONS AND ROOFS    111

Rubble stone  
Concrete  
  
Structural Systems  
Covering Systems



**CONTENTS**

---

chapter **4**    **PERFORMANCE**    **119**

---

STRUCTURAL    121

Earthen walls  
Straw bale walls  
Material Testing

THERMAL    127

Base Case  
Urban Analysis  
Rural Analysis

---

chapter **5**    **PROTOTYPES**    **153**

---

CONVENTIONAL BASE CASE    157

Standard suburban

RURAL PROTOTYPE    161

Rectangular

URBAN PROTOTYPES

“U” type courtyard    165  
“L” type courtyard    169  
2 - story row house    175

---

**END NOTES**    **181**

**ANNOTATED BIBLIOGRAPHY**    **184**

**APPENDIX**    **199**

Thermal Performance Modeling Data



## PREFACE

This book is about design and construction, materials and culture, human habitation and intentions. It considers the lessons which traditional architecture holds for today's designers and builders. Traditional houses are of a time when people built for themselves, following shared ideas of what a house should be. These houses reflect the building practices of their geographic region, and the design ideas of the culture which produced them.

Of necessity, traditional housing responds to its climate and surroundings, making use of available materials. In its varied forms it expresses the ways of life of its inhabitants. As this study will illustrate, traditional houses provided comfortable and healthy places to live in humanely scaled towns and neighborhoods.

Prior to the availability of energy via the power grid, houses were a family's first and only line of defense in surviving the heat of summer and the cold of winter. Houses had to work on their own to provide adequate shelter and comfort. Thus the thick adobe walls of Sonoran row houses moderated the extremes of heat and cold of the high desert, and the deep porches of New Mexican ranch houses sheltered the walls from the elements while providing protected outdoor living space.

Since the early 1970s there has been a movement among contemporary designers and builders to incorporate traditional materials and design concepts into new buildings. This movement grew out of the environmental consciousness of the 1960s, when a new generation questioned the conventional wisdom of a society based on the continued reliance on unsustainable energy sources.

The U.S. Department of Housing and Urban Development (HUD) continues to investigate and promote housing that is economical to build, durable, and energy efficient over its lifetime. This Special Study was commissioned to evaluate traditional materials and house types as they might be applied to the design of new housing in the Southwest.

Many low-income families in the U.S./Mexico border region cannot afford to buy adequate housing, and end up paying an excessive amount of their income to rent poorly constructed apartments. Conditions are far worse on the Mexican side of the border, where greater poverty and overcrowding are common features of border cities.

This study explores to what extent traditional designs and materials are relevant to contemporary efforts to create higher quality affordable housing for low and moderate income families in the border region. It analyzes both the design ideas evident in the organization of the houses, and the materials from which these designs were constructed. It discusses the advantages and limitations of each traditional material or element, and quantifies its performance through engineering modeling.

We begin with an overview of the border housing problem and possible solutions to be found within traditional architecture and urbanism. The importance of town and neighborhood planning is considered.

Traditional housing of the Southwest, including examples from the Native American, Hispanic and Anglo cultures, is next presented in detail. Case studies consider the design, technology, and applicability of traditional examples to today's housing.

This is followed by an analysis of traditional construction materials -- adobe, rammed earth and straw bale -- with regard to their structural and thermal performance. The final chapter presents and evaluates prototypical housing designs based on the traditional design ideas explored here.

This book is intended as a guide for the non-profit developer and its design team in applying the relevant lessons of traditional architecture to the design of new affordable housing. It should make more widely known the principles of energy efficiency, durability and low life-cycle costs, as well as cultural appropriateness, found in the traditional housing of the southwestern borderlands. It is offered in hopes that it will prove useful to others in the development, design and construction of affordable housing in the Southwest.

# THE US/ MEXICO BORDER REGION

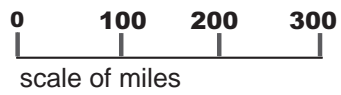
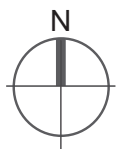
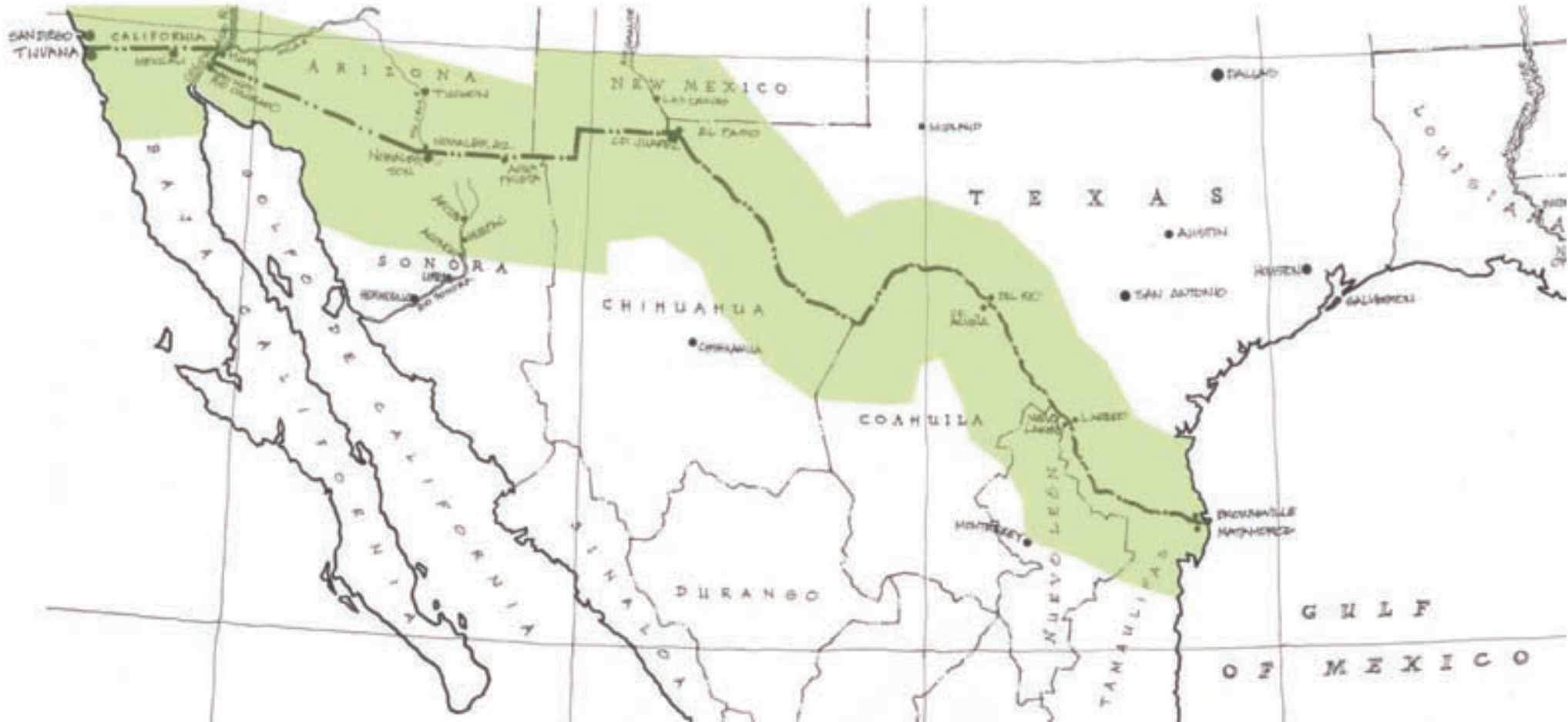

*US/ Mexico border region*





# **PROBLEMS AND SOLUTIONS**

chapter **1**

the border region / la franja fronteriza



*Aerial view of the Sonoran Desert along the Arizona/ Sonora line. The land knows no boundaries. The desert has a stark, desolate beauty, yet can be deadly for those trying to cross on foot. Photo: B. Vint*

## THE BORDER REGION LA FRANJA FRONTERIZA

The U.S./Mexico border is among the world's longest, stretching over 1,500 miles from San Diego to Brownsville, from Tijuana to Matamoros. This imaginary line both divides and unites two great countries, cultures, and peoples: those of the United States and Mexico.

The border separates Baja California, Sonora, Chihuahua, Coahuila, Nuevo León and Tamaulipas from California, Arizona, New

Mexico and Texas. The geography includes the mountains and plains of the Sonoran and Chihuahuan deserts, and extends from the Pacific Ocean on the west to the Gulf of Mexico on the east.

The climate is predominately hot-arid, with summer daytime temperatures exceeding 110° F and yearly rainfall averaging less than 12 inches. Mountainous areas along the border are above the frost line, experiencing

cold winters as well as hot summers. Along this line one of the world's most highly developed countries meets a nation still in development. This contrast creates intense urbanization in the border cities, particularly on the Mexican side, as millions of people move north in search of work or seeking to cross the line *al otro lado*: to the other side. On the U.S. side many families in rural areas continue to live in poverty.

What a U.S. Citizen would call the southwest is, for a Mexican, the far northwest. In comparison with the central and southern parts of Mexico the northwest is an arid wasteland. This contributes to disaster when people from the south attempt to cross the northern deserts, not understanding the scarcity of water and the effects of the rapid dehydration which occurs in the intense heat of the desert.

Some who come north stop at the border and find work in *maquiladoras* (the so-called twin plants). Some cross seasonally to work in agricultural fields, harvesting lettuce, tomatoes, peppers and citrus. Others use border cities as stopping points on their journeys north and south, meaning that these cities have a fluctuating population of migrants.

There is a shortage of adequate affordable housing to accommodate this influx of immigrants, and many people are living in crowded, unsanitary conditions on both sides of the border. This study examines the traditional architecture of the region, looking not only at problems, but also at how people have built successfully in the past as an example for the future.

## LAS COLONIAS

On the Mexican side of the international line the result of rapid and unregulated urbanization can be seen in over-crowded, cluttered cities such as Tijuana, Nogales, Agua Prieta and Ciudad Juarez. In these cities houses are often built by their owners using salvaged materials: scraps of wood, cardboard, factory pallets and corrugated tar paper. Groups of these houses form shanty towns, know in Spanish as *colonias*.

In central Mexico's well-established cities, a *colonia* is simply a neighborhood. There are many wealthy colonias in Mexico City: Colonia Roma, Colonia del Valle, Colonia Condesa. Along the northern border, however, the word has taken on a new meaning. Colonias here are the squatter's settlements which appear overnight on the outskirts of towns, built by newcomers for whom there is no housing.

Colonias result from *invasiones* (invasions) in which squatters (popularly called *paracaidistas* - parachutists -- because they suddenly appear as if they've fallen from the sky) move in under cover of darkness and build on land owned by others. The colonias lack the basic urban infrastructure of potable water, sanitary sewer, electricity and roads.



*Colonia in Tijuana. The houses of paracaidistas (squatters) are built on marginal land at the edge of town, hilly, inaccessible and hard to build on. Shacks evolve by piecemeal replacement with permanent materials (cinder block and concrete). Gradually the colonias become permanent neighborhoods, as electricity and roads are added. Photo: A. Vint*

South of Tucson, Arizona, are the twin border cities of Nogales, Arizona and Nogales, Sonora. Ambos Nogales (Both Nogales) were founded as an international railroad crossing in the 1890s. By the time of the Mexican Revolution (1910 – 20) the two towns had only a couple thousand inhabitants between them. In 1960 Nogales, Sonora had a population of 30,000 while Nogales, Arizona had half that amount. By 2004 Nogales, Arizona has grown to 20,000

inhabitants, while Nogales, Sonora is home to over 400,000 people – more than twenty times the size of its neighboring town on the U.S. side. This represents an urban expansion of over one thousand three hundred percent (1,300%).

There are more than 75 maquiladora factories in Nogales, Sonora, employing over 30,000 workers. The maquilas, or the so-called twin plants, employ Mexican workers at a fraction

of U.S. wages in the assembly of components for duty-free re-importation to the U.S. On the U.S. side are row upon row of warehouses where the assembled goods are stored awaiting shipment. On the Mexican side are the factories, and the colonias that house the work force.

The colonias, for all their squalor, represent affordable housing to those who build and dwell in them. With no rent or mortgage to pay, housing is free – leaving what money is available to meet other needs of the family, such as food, clothing, fuel, medicine, and school supplies. Colonias are often located near factories, meaning that transit is not a great necessity. While crowding has serious drawbacks (lack of privacy and sanitation to name but two), it also encourages social interaction. There are many neighbors living close by, often extended family members, who provide a social support group in matters of day-to-day life: watching children, helping with chores or house raisings, support during crises, and so on.

Although many colonias are surprisingly vibrant communities, the inadequacy of shelter takes its toll in many ways, from illnesses due to contaminated water (dysentery and hepatitis) and the lack of weather-tight houses (chronic bronchitis, pneumonia, flu and colds), to deaths each winter from asphyxiation or fire due to using gas burners or wood fires to heat combustible shacks.

## AMBOS NOGALES BOTH NOGALES

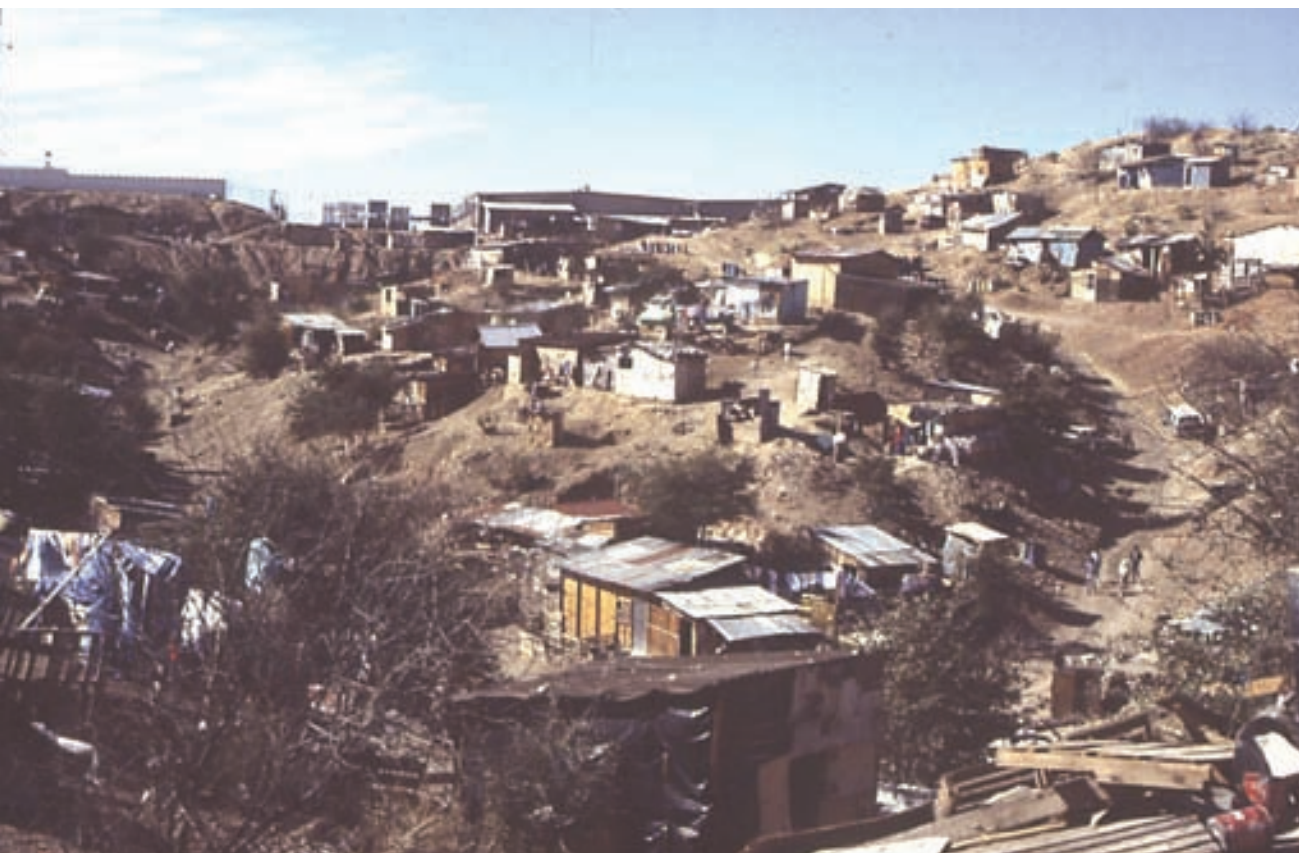

*Colonia Los Tápiros, Nogales, Sonora. Maquiladoras are located at the top of the hill, with semi-trucks beside them waiting to carry finished products north. Worker's housing sprawls outside the factory fence. Photo: B. Vint*



Despite the poverty and ugliness of the colonias, people who find no alternative than to build and live in them yet attempt to create beauty. Often the humblest shack has a small patio with flowering potted plants, as a family attempts to transform a small part of the outdoors into a micro climate of fresh air and greenery. The patio or courtyard is

a Latin concept that can be traced back to Spain, Morocco and ancient Rome. To find this Mediterranean design idea alive and well in border shanty towns is a testament to the strength of culture, even under great distress. The courtyard is an essential concept for the design of new affordable housing for the border region.

*Beauty amidst the chaos: a private patio in a hillside house in Tijuana. The traditional courtyard employed in a modest dwelling in a colonia. Photo: B. Vint*





Colonia culture has crossed the border into the United States, along with subsistence-level immigrants. U.S. colonias are often unregulated rural communities of substandard manufactured housing, rather than the dense urban squatter settlements of the Mexican border cities. HUD defines a colonia as a residential area lacking potable water and/or sanitary sewer, and having an unsafe or inadequate housing stock. This definition fits numerous areas along both sides of the international line. U.S. colonias are usually settled by recent Mexican or Central American immigrants working in agriculture, and are seen as an extension of border colonias as they evolved in Mexico, spreading along the entire border.

Unregulated aggregations of mobile homes, such as *la Perra Flaca* north of Douglas, Arizona, are typically set up as farm labor camps on farmland rented to immigrant workers. In these cases there has been no review by planning authorities, and no formal subdivision process involving engineering of roads and utilities. They are generally without sanitary sewer connections, often with septic tanks and leach fields, and occasionally with only cesspools. Water is supplied from private wells or delivered by private water companies, and is of dubious quality. Lot boundaries are ill-defined.

Innovations in manufacturing and design continue to increase the market share of mobile homes. The efficiency of the assembly line outstrips the inherently inefficient nature of site-built houses. Mobile homes realize the promise of modern architecture: houses

can now be mass-produced like cars or washing machines.

Factory methods require lightweight frame construction so that finished units or wall and roof panels can be transported to erection points. Frame construction in desert climates is at a disadvantage, for it has minimal thermal mass. Wood frame construction is also susceptible to termites and rot, reducing its longevity and increasing its life-cycle cost.

Traditional desert houses the world over have thick earthen or stone walls to moderate

the extreme climate. Small, deeply recessed openings reduce the glare from the intense sun. These responses to the desert environment have been overlooked in recent practice. Frame/stucco is expedient, quick to erect and therefore less costly than adobe. It is however more costly to heat and cool. Without massive walls to stabilize the desert's temperature extremes -- 105° days followed by 60° nights -- the fluctuations of day and night temperatures make it necessary to run mechanical air conditioning to maintain comfort.

## COLONIAS IN THE U.S.

---



*"Colonia" mobile home park outside Yuma, AZ. Photo: B. Vint*



*As in the Mexican examples, unplanned mobile home parks evolve into permanent neighborhoods as people add on.  
Photo: B. Vint*



*USDA sponsored affordable housing subdivision in Yuma, AZ. The designs are conventional detached suburban houses.  
Photo: B. Vint*

In Chapter 4 of this study the effects of thermal mass are analyzed through energy modeling to quantify their benefit in terms of comfort and energy conservation, in contrast with a base-case example of a wood-frame manufactured home.

Affordable housing subdivisions using conventional designs and frame/stucco construction have produced low-density suburban environments as seen in the photo at lower right. While technically adequate, this type of housing lacks regional appropriateness in both environmental and cultural senses.

Despite their differences, both sides of the border share a common culture of minimal housing for workers and their families. In the design of new affordable housing, architects, planners and administrators -- that is, the decision makers of community development -- must consider not only first costs, but life-cycle affordability in terms of energy and maintenance costs, as well as cultural factors such as house form and community space.



Tucson, AZ Typical contemporary subdivision. Photo: B. Vint



## CONTEMPORARY SOUTHWESTERN HOUSING



Tobono O'odham wa:tbo (ramada) built of mesquite posts and ocotillo cactus stalks. The shade structure captures the essence of desert architecture. Photo: B. Vint

Over the 20th century the population of the Southwest has grown by a factor of 100, representing an increase of 10,000%. The great majority of population growth came after World War II. Initial urbanization was driven by the regional military bases which brought recruits through the Southwest for training or on their way to the west coast for deployment to the Far East. Many young soldiers were impressed by the warm winters, the clean, dry air, and the beautiful natural setting, and brought their families out during the post war baby boom. Currently, retirees escaping the harsh winters of the east or mid-west are moving to the Southwest in large numbers. There is an increasingly aged population.

This rapid growth is typical of sun belt cities including Albuquerque, El Paso, Phoenix, Tucson and Yuma. There has been a continual strain on the housing stock and a chronic lack of affordable housing for young families, working people and recent immigrants. A look at the southern Arizona city of Tucson presents a case in point of the southwestern housing crisis.

The lack of adequate affordable housing is a pressing problem in Tucson as elsewhere. The City of Tucson Department of Community Services estimates that over half the households in Tucson are unable to purchase market-rate housing, yet they can address only a fraction of this need.

## SAN XAVIER DISTRICT, TUCSON



*San Xavier District Tobono O'odham Nation, Tucson. The mobile home has little thermal insulation and no thermal mass, so that it becomes super-heated in the summer. Note evaporative cooler ("swamp box") on roof. Photo: B. Vint*



*Conventional frame & stucco affordable housing at San Xavier District. Note the thin walls, which are unable to moderate the heat and glare of the desert sun. This type of house requires air conditioning to remain comfortable, resulting in high utility bills for families who often cannot afford them. Photo: B. Vint*



*Traditional early 20th century Tobono O'odham extended family housing cluster at San Xavier District. Note adobe walls, minimal wall height and small size of houses. Photo: B. Vint*

The city of Tucson, Arizona, is composed of many culturally distinct communities. Tucson's earliest inhabitants, the *Tobono O'odham* (Desert People), are today recognized as the Sovereign Dependent Tohono O'odham Nation. The San Xavier District of the Nation is located southwest of the city center and remains a rural village 300 years after the arrival of the Spanish. The O'odham are traditionally a rural people, and never developed urban architecture. They live in informal clusters of houses in the desert based on kinship structure.

The O'odham first built pit-houses or *ki*, domed shelters of brush and mud partially sunken into the ground. Next to the *ki* stood a *wa:tho* or arbor (*ramada* in Spanish) to provide shade. Much of the time the O'odham lived outdoors. The *wa:tho* is the essential desert architectural form, providing both shade and cross ventilation.

In 1693 Spanish missionaries reached southern Arizona, introducing adobe bricks and the resulting rectangular house form. Today the mobile or manufactured home is the most frequent affordable housing choice of tribal members. Second to this is the Federally funded tract home, built by professional contractors using conventional materials.

Economically the Tohono O'odham are among Tucson's least advantaged populations. There is a continuing need for affordable housing on the District. Given the rural tradition of the Tohono O'odham, this is an environment in which a detached rural affordable house-type appears to be an appropriate solution.



*S. Meyer Ave, Barrio Viejo, Tucson: adobe row houses in the Sonoran tradition, ca. 1870 Photo: B. Vint*

In the 19th century, the descendants of Tucson's Hispanic settlers built much as their Sonoran counterparts did in Ures, Aconchi and Arizpe: simple, massive houses with thick adobe walls, placed close to the street, and with gardens or courtyards behind or inside the houses. This is the traditional architecture of southern Spain and northern Africa, of Andalucía and Morocco, brought to a part of the new world with a very similar climate. It is a pedestrian-based vernacular, belonging to the pre-automobile era. Nonetheless it holds lessons for today's planners and architects, in the realms of environmental design and urbanism.

South of Tucson's central business district is a four-block square of Hispanic urban architecture, known as Barrio Viejo. It is what remains of a much larger neighborhood that was demolished in 1970 to make way for a place called the Tucson Community Center. Over half the old Barrio was destroyed during urban renewal. More than 200 adobe buildings were lost. In the spirit of their time, city planners wished to re-make Tucson as a "modern, forward looking city," rather than preserving the historic center. This is now widely recognized as an error.

The urban planners of the early 1970s intended to demolish the entire Barrio and rebuild in a modern image, but budget limitations prevented them from executing their entire plan. Therefore there remains some surviving Sonoran architecture to instruct us in the ways of urbanism.



In Tucson there yet remain streets lined with adobe houses, creating courtyards, micro climates, oases in the desert. With houses placed close together or sharing walls, a relatively high density was achieved despite the fact that the houses are generally only one story in height. The types of housing found in Barrio Viejo - the row-house, the zaguán house and the courtyard house - are explored in detail in *Ch. 2* of this study.

## BARRIO VIEJO, TUCSON AZ



*Mural of Barrio life by Francisco Franklin.  
Photo: C. Neumann*



*S. Meyer Ave., Barrio Viejo, Tucson: Transformed Sonoran rowhouse. Built ca. 1870 as a simple adobe box, a hipped roof was added in the late 19th Century. Photo: C. Neumann*

*S. Meyer Ave., Barrio Viejo, Tucson:  
Courtyard as outdoor room.  
Photo: B.Vint*



*S. Convent Ave., Barrio Viejo, Tucson:  
Courtyard creates cool micro climate.  
Photo: B.Vint*



With the arrival of large numbers of Anglo immigrants in the early 20th century, and the advent of the automobile, Tucson's architecture changed dramatically. The detached house, reflecting Anglo traditions imported from the eastern United States, became the predominant model of development. Streets became much wider to accommodate cars and to attain privacy between the houses. The gridiron pattern of streets was begun, which now extends to all ends of the city. This represents the beginning of the lower density development which now typifies Tucson and much of the Southwest as well.

Although this type of urbanism may not be ideal for the desert, the early Anglo-traditional houses built in Tucson were well-adapted to the climate. Indeed they had to be, that people might comfortably live. The preferred house type was the bungalow, featuring a deep shady porch and wide overhanging eaves. Houses were built at the center of their lots, leaving space on all sides for vegetation. This is the striking difference between the Hispanic and Anglo traditions: the Hispanic house is inward-looking to a courtyard, while the Anglo house looks outward.

Within the overall city of Tucson, early 20th century Anglo development has a humane scale and a vernacular expression. Houses of a vernacular concept were built one or two at a time by small builders and developers, so that a variety of house types is represented. There is authentic individuality to these early neighborhoods, which is lacking in much of the housing that followed in the expansion of the post-World War II years.

## WEST UNIVERSITY NEIGHBORHOOD, TUCSON



*Bungalow in West University, Tucson. This type of house responds well to the climate, and has a pedestrian oriented presence on the street.*  
Photo: B. Vint

Since 1945 Tucson has expanded rapidly on the basis of sun belt migration and automobile ownership, resulting in sprawling suburbs of predominately single story detached houses often connected by six lane roads to move traffic amongst them. Since 95% of Tucson has been built since the end of World War II, the great majority of the built environment is characterized by this type of development.

In a desert environment such as Tucson, low density development is inherently inefficient in its use of land and the public investment in infrastructure required to support it.

## SUBDIVISIONS

---



*Sprawl development outside Tucson, Arizona. Photo: B. Vint*



*Wood-frame house sheathed in foam awaiting synthetic stucco coating. Glue-on foam moldings seek to provide some differentiation between identical units. Photo: B. Vint*



*Prominence of garage opening in finished street facade expresses primacy of the automobile. Photo: B. Vint*



*Placement of houses results in side yards which offer neither privacy nor sufficient outdoor space to serve any useful purpose. Photo: B. Vint*



*Civil engineering to accommodate rain runoff from streets and roofs leads to concrete-lined drainages as public spaces. These developments are technically adequate, but raise environmental and aesthetic issues. Photo: B. Vint*

## THE SEARCH FOR SOLUTIONS

---



*Overview of Arizpe, Sonora, with the cathedral tower prominently marking the town square, surrounded by numerous examples of courtyard housing.. Photo: B. Vint*

The preceding summary illustrates both the gravity and uniqueness of border housing conditions. Yet throughout northern Mexico and the southwestern U.S. there are examples of successful traditional housing that provide a very satisfactory living environment. These examples are well worth studying to learn how and why they succeed, both in terms of their architectural design and the construction materials and methods employed

Northwestern Mexico and the Southwestern U.S. were once part of *La Nueva España*: New Spain. The legacy of Spanish culture in the region includes a tradition of town planning based on *La Recopilación de leyes de los reynos de las Indias*: the Laws of the Indies, which date to 1501. This document, issued by the Spanish Crown, was used by the conquering Spanish to establish their way of life in new lands. It contains 148 ordinances describing how towns and cities should be laid out.

The Laws of the Indies specify that a *plaza*, or central square, be created for each town or city. Surrounding the plaza are streets with homes brought to the street front, with private space contained inside at the *patio* or courtyard. This type of planning produced dense towns and neighborhoods without sacrificing privacy. The resulting urban form is compact, occupying less space in the landscape than today's suburban pattern of development.

To this day throughout Mexico and Latin America the plaza is an expression of civic pride, creating an island of tranquility in the

heart of the city. With shade trees, benches, and a gazebo or *kiosko*, the plaza is an inviting and cool place to meet, for everyone from young couples to families with children and retirees. The plaza in the city plays a role similar to the *patio*, or courtyard, within the individual house. Architects and planners north of the border would do well to note the beauty of Mexican plazas, and look for opportunities to create common spaces where all are welcome.

The nature and character of a community is derived not only from the quality of its housing, but from its urban form. The layout of neighborhoods determines greatly the type of housing possible, and the type of lives people may lead there. Is the neighborhood walkable? Is there a sense of both community and privacy? Are there safe, well-watched places for kids to play? Is there adequate shade and fresh air? What is the environmental quality of life?

## THE IMPORTANCE OF TOWN PLANNING



Ures, Sonora: The plaza is bordered by the city hall (Palacio de Gobierno) and the church of San Miguel Arcángel  
Photo: B. Vint

## THE RIO SONORA VALLEY

A particularly rich vein of traditional architecture is found along the banks of the *Río Sonora* (Sonora River), which runs south of the border from Douglas, Arizona and Agua Prieta, Sonora. In the 17<sup>th</sup> century Jesuit missionaries explored this fertile river valley, founding towns and missions. Today there remains an intact chain of towns named Ures, Baviácora, Huépac, Aconchi, Banámichi and Arizpe – places with indigenous names, but endowed with the cultural legacy of Spain: urban architecture.

The town of Aconchi, Sonora, was founded in 1639. Houses are distributed around a central plaza fronting a colonial-era church, beside which is a carpentry shop named appropriately enough *Carpintería San José* (St. Joseph’s Carpentry Shop). Aconchi is well known in Sonora for the production of wood furniture. Centuries after its founding, the traditional urban architecture of this Spanish colonial town continues to function as a livable environment for its inhabitants.

### ACONCHI, SONORA

Aconchi’s houses are built of adobe brick finished with lime plaster. The houses are placed close to the street with private patios within. Since the houses are grouped closely together, Aconchi is a compact, walkable town, with a comfortably-scaled streetscape. This approach to housing uses land efficiently, for there are no side yards to fill up with broken washing machines or old bicycles, and no front yards with lawns to water or weeds to pull. To apply these ideas in the design of new affordable housing, some contemporary realities must be addressed, foremost among these the automobile. Cars can be brought in through narrow alleys behind the houses to maintain a pedestrian connection to the street. This creates a lively street presence and improved defensible space, in contrast to the streets of U.S. subdivisions, dominated by garage doors and a lack of individuality.

The view over the roof tops of Aconchi as seen from the bell tower of the church reveals the key to this type of urban architecture: the continuous street front is maintained by joined houses, behind which are private patios or courtyards. The houses have an “L” shape in plan to create the courtyard space, while sharing walls with their neighbors on each side. Shared walls reduce both initial construction costs and life-cycle energy costs, by reducing the amount of exterior wall required and exposed to the elements. This type of row housing yields a higher density than the detached single-family house typical of U.S. subdivisions.



*Plaza de Aconchi, Sonora Photo: B. Vint*





*Aconchi, Sonora: the importance of shade in the arid environment. Photo: B. Vint*



*Aconchi, Sonora: street scene adjacent to plaza. Photo: B. Vint*



*Aconchi Sonora: view over the rooftops of courtyard houses as viewed from the east tower of church. Photo: B. Vint*

Arizpe is another gem of Spanish Colonial urbanism, a town of 15,000 which in the 17<sup>th</sup> century was the capital city of the entire region including Sonora, Arizona, Chihuahua and New Mexico. In the floor of the cathedral, a Jesuit structure from the first half of the 18<sup>th</sup> century, is the burial crypt of Juan Bautista de Anza, the Spanish explorer who founded San Francisco, California. Arizpe has all the elements of successful urbanism: walkable streets, public spaces, private courtyards, human scale,

and an accessible rural hinterland. To the present day Arizpe exists as an agricultural town surrounded by pastures and fields. The valley is well irrigated by the Rio Sonora. Wheat fields and fruit orchards abound, and beef cattle are raised for export to the state capital, Hermosillo. Those families who own a house or plot of land in Arizpe are able to earn a decent living from the land. However, the limitation is that only a certain number can live directly off the land, and as the population grows, many young people find

it necessary to move to the border cities of Nogales or Agua Prieta, or to Hermosillo to earn their livelihood.

Nonetheless, Arizpe holds important lessons for the architect and planner. The compact form of the town results from the predominance of courtyard housing, which permits higher density while maintaining privacy within each dwelling. A town with a comparable population built on the suburban model common north of the border would occupy four times the geographic area: the sprawling effect of suburbia is geometric.

## ARIZPE, SONORA

The greater efficiency of land use in Arizpe means that more arable land is left available for cultivation. This is a critical factor worldwide, as increasing urbanization consumes millions of acres of farm land, even as the population's need for food, clean water and fresh air increases.

The house forms of Arizpe are “L” and “U” shaped courtyard plans. These types of houses can be traced to ancient Greece and Rome. They are simple rectangular forms composed of rooms gathered around a central patio. They can be placed together side by side, or back to back, without compromising light, air and privacy for each house. Each individual dwelling obtains these vital elements from the patio, rather than from the perimeter. The urban form of Arizpe results directly from the courtyard house, and the types of housing blocks that can be assembled from it. The courtyard house achieves affordability by sharing walls between dwelling units: one can build a wall once, yet use it twice.



*Arizpe, Sonora: compact town form preserves surrounding landscape. Photo: B. Vint*

As is the case throughout the Rio Sonora valley, the houses are built of adobe. Roofs are framed with wood beams (*vigas*) and lathing (*latillas*) contained within parapet walls. This system of roofing, called *enterrado* in Spanish, is also found in Andalucía and North Africa, where it is known by its Arabic name, *alfarje*. The original roofing material in the historic period was earth: layers of adobe mud, approaching 12 inches in thickness, were applied over the *latillas*. Earthen roofs, like adobe walls, had the advantage of high thermal mass. However, because they were so slightly sloped and made of mud, they leaked chronically in the heavy monsoon rains of the Sonoran summers.

The earth roofs were supplemented in the 20<sup>th</sup> century with more steeply pitched roofs framed with milled lumber and sheathed with corrugated galvanized iron, added above the original earth layer. This has proven to be effective at water proofing -- inexpensive, and reasonably durable -- but has the drawback of being an excellent conductor of heat.

Nevertheless corrugated metal has become the predominate roofing type along the Rio Sonora, for its practical advantages. There is an insulation benefit to the attic air space created between the original earthen roofs and the upper waterproof roof of these Sonoran dwellings. The inward slope of the roofs as illustrated is ideal for harvesting rain water to irrigate the patios.

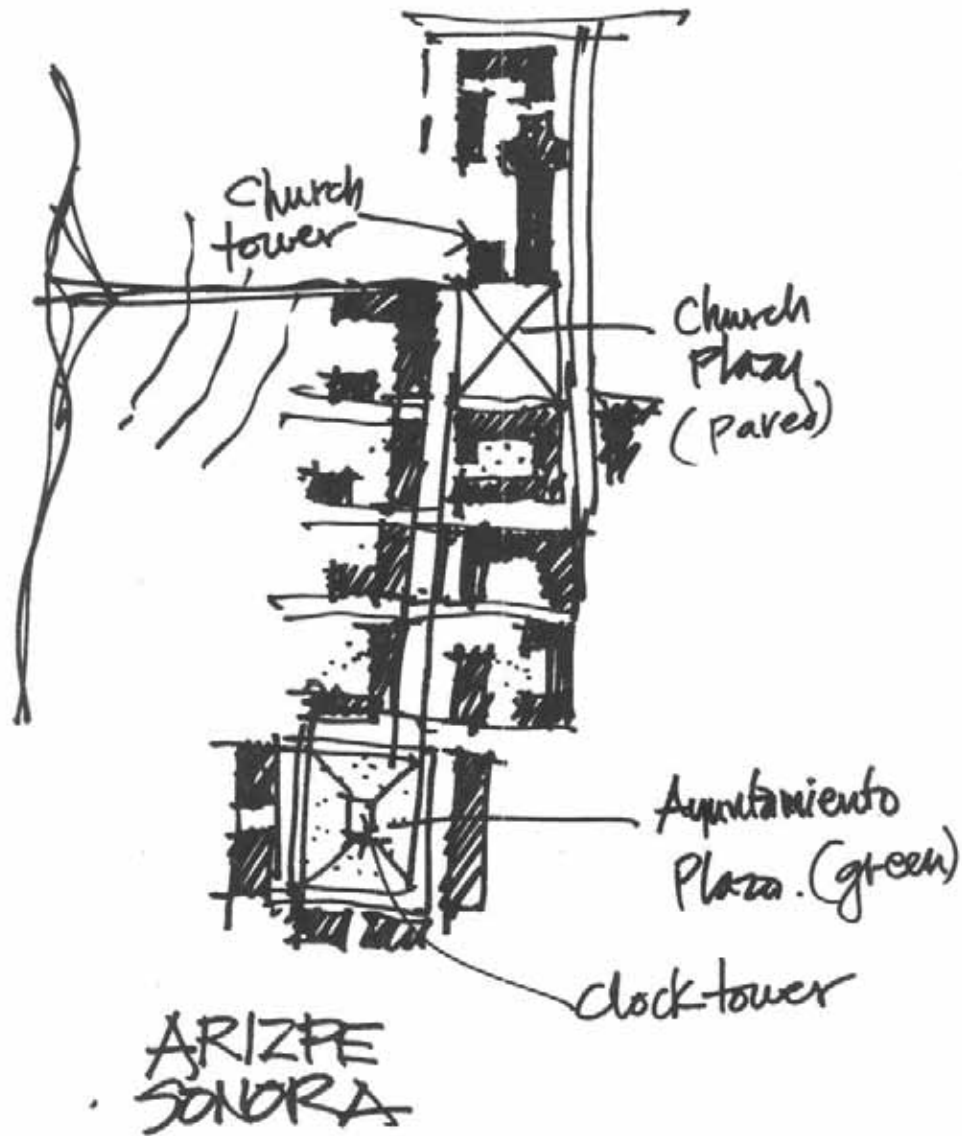

*Arizpe, Sonora: Sketch plan of town, B. Vint*



*L-shaped house with heavily vegetated courtyard at corner. Photo: B. Vint*



*Rural adobe house set into the hills above Arizpe. Photo: B. Vint*

## ARIZPE, SONORA



*U-shaped house at center of photo is a classical Latin design. Each room opens to a central patio for privacy, fresh air and light. The courtyard is the heart of the house. Grouping of volumes creates private patios within each dwelling. Photo: B. Vint*

Ures was the 19<sup>th</sup> century capital of Sonora. Today it is home to some 30,000 people. A lush central plaza with great shade trees provides a physical, as well as symbolic, center to the town. In a harsh desert environment, shade filled plazas function as oases for the townspeople. They create a sense of place and well-being, and are expressions of civic pride.

While nearly every Mexican town and city is graced by a plaza, and many of the same elements are employed – a mix of paving, planting, benches, shade trees and a band stand -- no two plazas are alike. Ures has a particularly successful plaza, with two permanent refreshment stands selling *raspados de nieve* and *cimarrones*, locally made ices with fruit toppings and part of the traditional strategy for desert survival. The plaza functions much like a community living room, a place for people to gather and socialize, and creating a very human element in the urban landscape.

Adobe brick making was introduced to the Rio Sonora by the Spanish over three hundred years ago. To the present day, adobe construction remains widely practiced. Most of the buildings of Ures and other Rio Sonora towns are built of adobe. Houses are plastered with lime and sand to protect the mud bricks from weathering.



*Street scene in Ures. Massive trees are evidence of central patio. Note un-plastered adobe garden wall to right. Photo: B. Vint*

## URES, SONORA



*Ures, Sonora: Plaza within the city functions similarly to the patio within the individual home. Photo: B. Vint*

Many of the houses surrounding the plaza of Ures are built on the principle of the zaguán: a central entry hall / breezeway that connects from the street to the patio at the interior of the house. In a traditional courtyard house, the zaguán is the transition from public to private, and also serves to permit the passive ventilation of the house. The zaguán is large enough to serve as a sitting room. As the street in front of the house is heated by the sun, air rises from it: meanwhile air

in the patio is cooled by moisture from a concentration of plants or a fountain. As evaporatively cooled air sinks into the patio it is drawn through the zaguán by the heated air rising off the street. The zaguán, being open to adjoining rooms, draws fresh air into the interior of the house by means of natural convection.

From the street, the zaguán connects to the *corredor*, which crosses one end of the patio.

The *corredor* is a covered outdoor space connecting the two sides of a courtyard house. Unlike the typical single-family American home placed in the center of a plot of land, the courtyard gathers the exterior space at the center of the house, where it is made private by the placement of rooms along the sides. This is a fundamentally different conception of the house, an expression of Spanish or Latin culture, and well-suited to the desert environment of the U.S./Mexico borderland.



*Ures, Son View of zaguán (entry hall) from street.  
Photo: B. Vint*



*Corredor and patio of house in Ures. The corredor provides a connection between the two sides of the house, and the patio captures a small piece of the exterior, transforming it with plants and shade into a cool micro climate.  
Photo: B. Vint*

The courtyard or patio house lends itself well to infill development of vacant land within an existing urban context, as houses can be built to property lines. The perimeter walls can be windowless or shared with adjacent dwellings for economy of construction as well as energy savings.

The patio serves to cool a house by natural ventilation and evaporative cooling. Cool air settles into the courtyard over night, cooling the floors and walls. During the day, heat rising from the patio creates convective currents, drawing air over plants or a fountain. Evapo-transpiration from plant leaves or a fountain lowers the sensible temperature of the air. The degree of cooling varies with many factors including relative humidity, elevation above sea level, the types of plants that will grow at a given location, and the degree of shading. While a quantitative analysis of this process is beyond the scope of this study, the prevalence of the courtyard house throughout hot-arid regions the world over testifies to its importance as a design strategy for desert dwelling (ref. Fuller Moore, *Environmental Control Systems*, p. 51).

Evaporative cooling is effective in hot-arid zones where relative humidity is low. Sensible heat is reduced by evaporating water into the air as latent heat. The total heat content of the air is unchanged. This system works where RH is consistently below 15%, which describes large areas of Arizona, New Mexico and Texas. Evaporative cooling uses significantly less energy than conventional air conditioning. The courtyard is thus both environmentally and culturally relevant to affordable housing in the Southwest.



*Ures, Sonora, The plant-filled patio in a traditional house cools by evaporation. Photo: B. Vint*

## HUEPAC, SONORA



*Huépac, Sonora Photo: B. Vint*



*Huepac street scene. Note the deep window recesses and shaded sidewalk resulting from placement of buildings close to the street.  
Photo: B. Vint*

Another intact colonial town in the Rio Sonora valley is Huépac. Here can be appreciated the effect of the street-wall created by the juxtaposition of adobe row houses. Also visible is the shading effect of thick earthen walls, with windows deeply recessed: direct sunlight is kept from striking the glass by the depth of the window openings.

An added benefit of the narrow streets with buildings located close to the sidewalks is that one side or the other of each street will always be shaded by the building mass. Thus pedestrians can walk in the shade of buildings, protected from the withering desert sun. This makes walking bearable even on the hottest days, something which is impossible in typical U.S. suburbs with their detached houses.

Traditional houses in Huépac are of adobe, although recent constructions have been built of standard 8 inch thick concrete block. Block houses, although durable, do not function well because concrete conducts heat quickly through the walls. Adobe structures have the advantage of thermal lag, as heat travels slowly through earthen walls. Adobe, as documented in Chapter 3 of this report, is not a good insulator: it is a good thermal mass.

The streetscapes of Huepac and other Rio Sonora towns provide excellent models for the development of future affordable housing communities in the U.S. Southwest.



*“For two centuries, common knowledge governed American spatial design. Common knowledge is neither folk nor literate but a complex mixture of both the “little tradition” transmitted by half-literate peasants and the “great tradition” of the literate, innovative minority of scholars, rulers, merchants, and of professional designers such as surveyors or architects.”*

John Stilgoe, *The Common Landscape of America*

Architectural design concerns the arrangement of spaces for human habitation. The space defined by traditional houses is both interior and exterior, private and public. The houses people build are as much a cultural expression as are their music, food or dance. Traditional houses spring from a centuries-deep well of shared experience, knowledge and values. This current of tradition running through society is still felt, although much weakened over the 20th century by the widespread advent of industrialized housing production methods and suburban consumerism --- which can be seen as a new culture, supplanting the old.

Following is a series of case studies of housing from the predominate southwestern cultural traditions, including both rural and urban examples. Among the most developed examples of urban architecture are the Native American Pueblos of Casa Grande, Arizona, and Acoma, New Mexico. These were followed by Spanish and Mexican towns, as evidenced by the courtyards and row-houses of Barrio Viejo in Tucson, Arizona. The Anglo tradition found expression in the isolated ranch houses of the Southwest, such as the Empire and the Gray. All of these traditions hold profound lessons for today’s designers and builders.

### Historical periods of the U.S. Southwest

Native American	4000 B.C. -- 1609 A.D.	(Settlement of Santa Fe)
Spanish	1609 A.D. -- 1820 A.D.	(Mexican Independence)
Mexican	1820 A.D. -- 1848 A.D.	(Mexican-American War)
Anglo American	1854 A.D. -- present	(Gadsden Purchase -- Present)





## Coolidge, Arizona **CASA GRANDE**

Among the earliest works of architecture in the desert southwest is the Hohokam Native American compound known as Casa Grande, Arizona. This imaginative name (Big House) was given by the Jesuit explorer-priest Fr. Francisco Eusebio Kino in 1693. Kino, a German-speaking cartographer from Trento in north Italy, was the first European to see Casa Grande. He found the ancient Hohokam site abandoned, yet with its earthen walls still standing. The central structure stood three stories tall, within the confines of a large walled compound containing numerous single-story room blocks joined together to form a dense townscape.

Hohokam culture flourished from A.D. 700 to A.D. 1450. Archeologists have charted the ascent and decline of this prehistoric civilization, identifying pre-classic, classic, and post-classic periods of development. The Casa Grande complex dates to the late classic period, as the culture was peaking and beginning to experience the stress of long-term drought that led to its abandonment.

Hohokam society was based on a sophisticated network of irrigation canals, some of which are still in use today by contemporary farmers. Irrigated crops supported dozens of city-states across the broad Gila River basin. Classic-period Hohokam settlements were walled towns, expressing the need to defend their sedentary agricultural civilization against competing nomadic peoples, including the Chichimecs (ancestors of the Apache and Aztecs). Early agricultural civilizations required a high level of social organization to permit cooperative labor in the planning and digging of canals, the planting and irrigating of fields, and the building of towns. The architectural legacy of these early desert dwellers is impressive to this day.

## TRADITIONAL PRINCIPLES

Casa Grande stands as a reminder of a vanished civilization, which endured for over 700 years before collapsing from environmental pressures. After centuries of cultural development, this early agricultural society could not resist the stress of a long drought. While it is impossible to compare the Casa Grande with contemporary conventional housing, it nonetheless demonstrates fundamental principles of how to build in the desert.

- Thick earthen walls for shelter and thermal mass.
- Simple rectangular building forms for ease of construction and structural stability.
- Compact shapes that minimize exposure to the elements.
- Small openings to reduce heat gain.

Today's society will not build another Casa Grande. Yet we can learn much by looking closely at how Native Americans built here seven centuries ago.

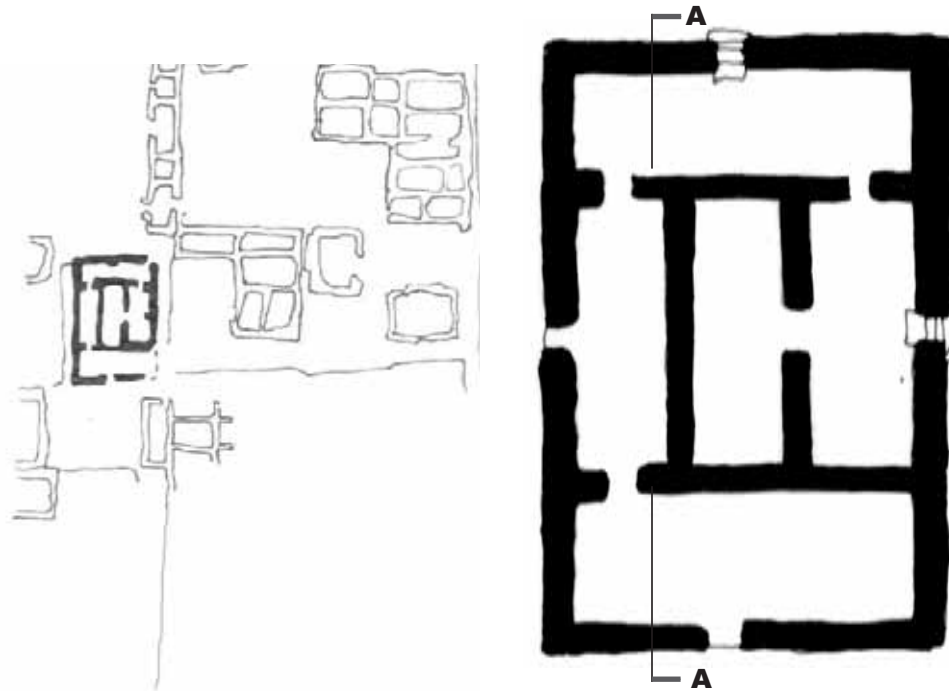

0 10 20  
scale in feet



*Site plan (l.) showing remnants of adjacent buildings & plan (r.)*

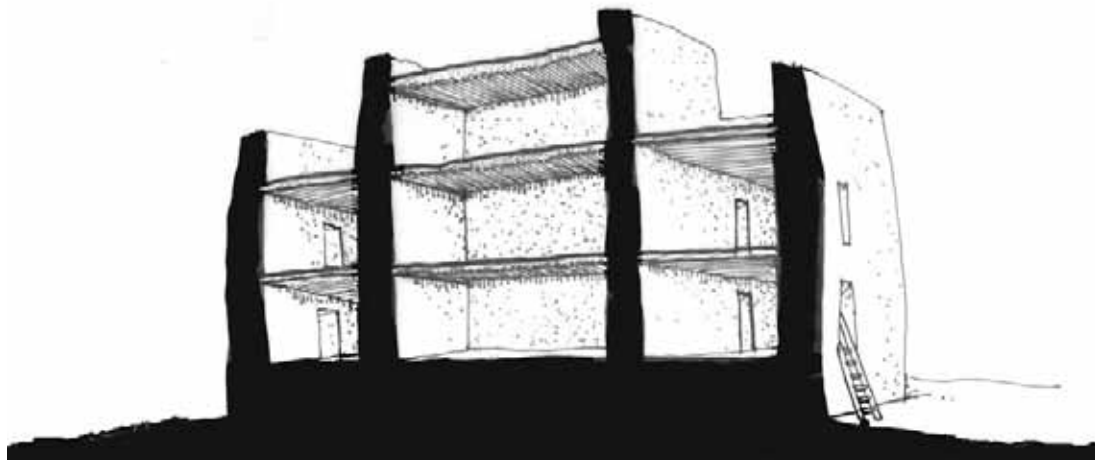

*Section perspective A-A*

## MATERIALS

The Casa Grande complex was built with earthen walls and a timber roof and floor structure. The walls were built by placing damp earth in layers, raising the walls gradually, layer upon layer, until the desired height was attained. This technique is called puddled adobe and resembles today's rammed earth, in that it produces a monolithic earth wall. That is, the earth is not molded into bricks which are then laid in mortar: rather, the entire wall is formed of earth heaped upon earth and compacted so that it fuses into one mass. It is analogous to the coil method of building clay pots, which was also practiced by the Hohokam. In this case, the vessel created was not a water jug but a building – a container of space for human habitation.

One factor in the longevity of these structures is that they were built with caliche, a naturally occurring soil in the southwest

that is rich in calcium carbonate, or lime. The Hohokam thus selected a building material containing a natural stabilizer, that helped the mud walls resist dissolving with centuries of rain that have fallen since the building was erected. Even in a desert which receives less than 12 inches of rain annually, over the centuries this adds up: in 700 years, nearly 700 feet of water have poured over Casa Grande.

Water damages earthen structures both upon entering the walls (water acts as a solvent, turning adobe or rammed earth back into mud) and as it exits (carrying soluble salts in solution to the wall surface, which crystallize as the water evaporates thereby causing “salt erosion” – as salt crystals form in the pores of the wall, they crush the surrounding material by their expansion). Cycles of wetting and drying are the agents of adobe deterioration. Suffice it to say, had the Hohokam built the

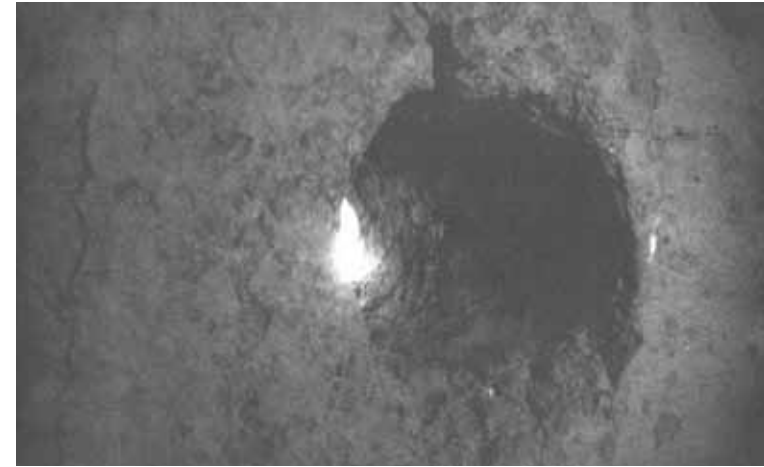

*“The sun’s rays touch the edge of one of the openings in the wall of the Casa Grande at summer solstice.” Photo courtesy of Western National Parks Assoc.*

Casa Grande with unamended mud, it is unlikely that it would have lasted so many hundreds of years.

The floors and roofs of Casa Grande were structured of timber beams with brush lathing spanning between them, and earth fill over this. Spanish and Mexican immigrants to the Sonoran Desert used the same system centuries later. It is analogous to modern reinforced concrete construction, with the wooden elements providing the tensile strength (like reinforcing steel), and earth the compressive strength (like concrete).

Ironically, Mexican and Anglo farmers and ranchers hastened the deterioration of Casa Grande in the 19<sup>th</sup> century. These early pioneers took the beams out of Casa Grande to use in the construction of their own houses. Once the roof was removed the earth walls were of course more exposed to the elements, and began to erode more quickly, in spite of which the 700 year old ruin still stands. The Casa Grande complex is a demonstration of the durability of earth construction, if sound design principles are followed.



*Casa Grande ca. 1890. Photo courtesy of the National Park Service*



*Labyrinth etched in earth at interior of Casa Grande.  
Photo courtesy of the National Park Service*

## DESIGN FEATURES

The Casa Grande may have been a ceremonial or sacerdotal structure, and may have contained a granary (the community's store of grain being its treasury). The structure may also have served a defensive purpose, as the tallest building in central Arizona providing a suitable vantage point to survey the surrounding broad, flat floodplain of the

Gila River. As is typical of early agrarian societies, it is likely that the leadership was priestly and that their religion was based on bringing rain, knowing when to plant, and so on. There are indications that astronomical observations were built into the structure. A spiral shaped maze is inscribed in the earth surface, being possibly a religious symbol or calendar. Small apertures in the Casa Grande have been found by archaeoastronomers to align with sunrise at the winter and summer solstices, and other openings that align with the equinox. The building itself may have served as a sort of calendar, letting the priests know when to predict the rainy season, and order planting of the fields.

Casa Grande is evidence of a sophisticated society with knowledge of the abstract calculations necessary for its construction. The plan form is reminiscent of early Greek temples in its simplicity and balanced proportions. It is made up of five elongated rectangular rooms per floor, grouped so that a three-part division is achieved either north to south or east to west. That is, three long rectangles are placed side by side forming a center section, with the remaining rectangles placed one across each end. This resolves into a single large rectangle. The plan resembles a Chinese ideogram or symbol, it has such a strong visual arrangement. The center room rises to three stories in height. The surrounding rooms are two stories in height. There are eleven rooms all together, five each on the first two floors plus a single upper room in the center bay.

This building measures 42 feet in width by 64 feet in length, and is from 30 to 45 feet high at the center. The earth walls are battered (tapered in section) and nearly four feet thick at their base, diminishing in thickness as they rise. This makes great sense from both the practical construction point of view (reducing the amount of material handled,

and making it easier to raise the walls using the puddle adobe method) as well as from the structural viewpoint (walls should be thicker at their base as the greatest load is accumulated there). Battered walls also have a low center of gravity, making them more stable in resisting overturning forces such as earthquakes.

The simple rectangular plan creates an extremely stable shape for a rammed earth structure: every corner and cross wall serves as a buttress to resist lateral forces. The massive walls themselves have a stable proportion, as their height-to-thickness ratio is less than 10:1 -- thereby conforming to today's earth building codes. Without a doubt the Casa Grande is a major work of architecture, worthy of careful consideration for the lessons it holds in earthen construction. It is, after all, one of the oldest structures in all of North America.

## THERMAL PERFORMANCE

Given the great thickness of the bearing walls, Casa Grande has an enormous amount of thermal mass as a proportion of its interior space. More than one third of the gross floor area is solid earth, in addition to the earthen roof and floors. Openings in the massive walls are few and small. Given its two and three story configuration, the inner rooms are extremely well sheltered from the harsh desert climate. When the structure was intact and inhabited, it would have functioned much like a cave -- with so much mass to stabilize the ambient air temperature, it would have remained a comfortable shelter year round. Limitations of the structure are that cross ventilation is restricted, and natural light and air are inadequate by today's expectations.

## New Mexico **ACOMA PUEBLO**

Sited on a mesa top in northern New Mexico, Acoma is a powerful expression of Native American culture and community. High above the desert floor, in one of the most dramatically sited cities on earth, row upon row of terraced dwellings face south toward the winter sun. The arrangement of the housing blocks leaves open space between for circulation, processions and ceremonial plazas. Crops were grown below on the valley floor. Access was by hidden trails along the cliff face, with hand and foot holds sculpted into the rock. For at least 600 years the Acoman people lived in splendid isolation, developing and refining their culture of architecture, pottery, dress, customs and religion.

Spanish explorers encountered Acoma in the early 1600s as they pushed north in search of wealth and power. The legend of the fabled “Seven Cities of Cibola” was based on fanciful accounts of early travelers, who had seen Acoma’s skyline rising above the desert plain and imagined they saw a city of gold. The micaceous soil used for plaster may have created this illusion, as flecks of mica in the wall finish would catch the sun and glint like gold.

The Spanish soon enough discovered that Acoma and other Native American settlements of New Mexico were built merely of stone and mud. They nonetheless represent an advanced civilization based on the cultivation of food crops, and a pattern of dense urban living. There was no concept of private property: the land was of the Creator, belonging to everyone and to no one. People worked cooperatively for the good of the whole.

Such sedentary agricultural settlements are the basis of all culture, for they permit the contemplation of the cycle of life, of the stars and the seasons, which is the beginning of abstract thought. The Spanish described the New Mexican Indian villages as pueblos, or towns: they spoke of Acoma Pueblo, Zuni Pueblo and Taos Pueblo. Four centuries later Anglo immigrants applied the term “pueblo” to the people themselves, who are colloquially known as Pueblo Indians.

Acoma Pueblo remains largely intact to the present day. Acomans welcome visitors to their pueblo, which they call “Sky City” with good reason. Although located more than 150 miles from the U.S./Mexico border (HUD’s definition of the border region), it is included here as a relevant example of high density, low rise housing. The principles of Acoma are directly applicable to the design of new affordable housing in the desert southwest.

## TRADITIONAL PRINCIPLES

Perhaps the most important lesson of Acoma is density and community form.

- High thermal mass walls (stone & mud).
- Houses face south to receive winter sunlight.
- Two & three story housing achieves high density and efficient use of land.
- Roof terraces on south to provide private outdoor space for each family.
- Row houses share walls along the length of the dwellings, reducing amount of exterior walls and exposure to the elements.
- Groups of row houses are placed to create public space between the blocks of dwellings, for gathering and ceremonies.
- A balance of community and privacy.
- Rainwater harvesting occurs on the mesa top in hollows dug into the stone surface.

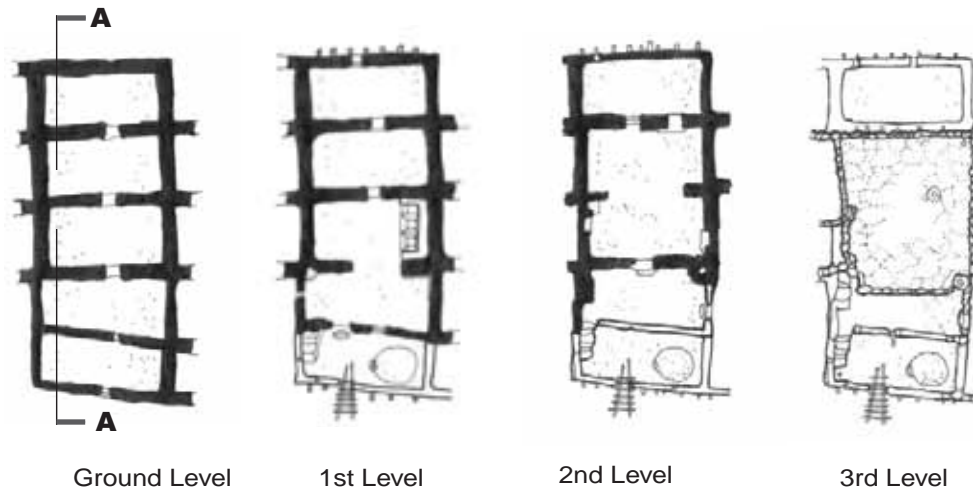

Ground Level      1st Level      2nd Level      3rd Level

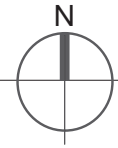
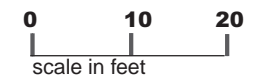

*Acoma Pueblo, Block 1 Unit 3 Plans*

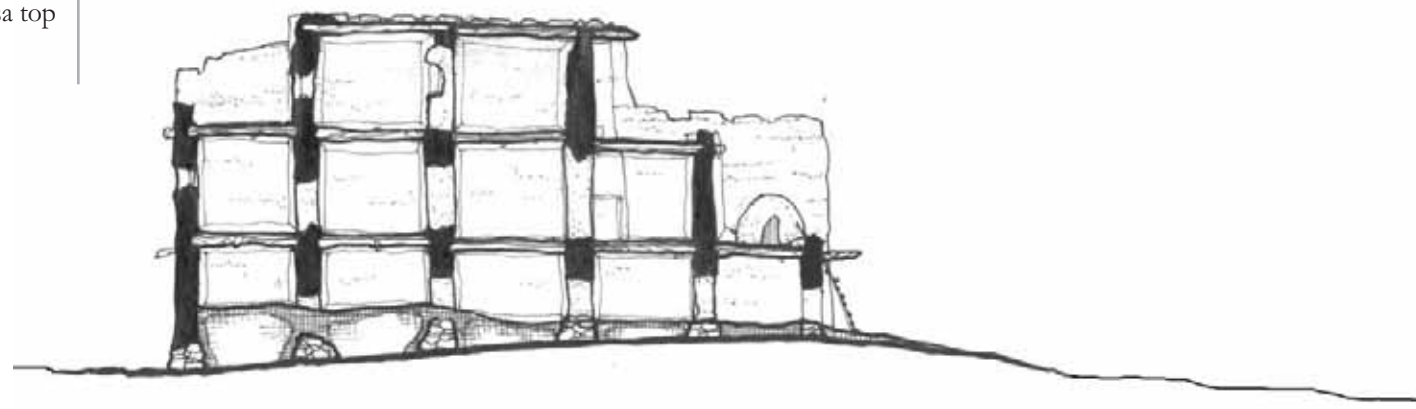

*Acoma Pueblo, Block 1 Unit 3 Section AA*



## MATERIALS

The walls of Acoma Pueblo are built of stone laid in mud mortar, and plastered with mud to protect the mortar from weathering. The rock of the mesas provided the building material. Earth for mortar and plaster had to be brought from the valley below, as did timbers to support the floor and roof structures. Piñon poles and branches used for beams span across the short dimension of each room. Lighter poles, cane and brush were laid perpendicular to the primary beams, and mud plaster was spread over this. The floors were finished with smooth paving stones laid in mud mortar. The flagstones of the terraces provide a durable surface as well as an effective thermal mass to absorb the warmth of the winter sun, re-radiating this passively stored solar energy into the interior over night.

Water for mixing mortar and plaster was harvested in hollows in the stone mesa top. This source of water continued to serve the pueblo as a renewable source of domestic water, although it had to be supplemented in the dry season of the year with water brought in clay pots up from springs at the base of the mesa.

Access to individual dwellings is via the south terraces by means of tapering pole ladders designed for stability. Originally small, high doorways the size of today's windows gave access to the interiors. The original windows of Acoma were sheets of translucent mica set in the stone walls, providing diffuse natural light to the interior while maintaining privacy. Only one original mica window remains. Since the arrival of the Spanish and later

*View across roof terraces of Acoma Pueblo ca. 1930.  
Photo: A. C. Vroman by permission of UCR  
California Museum of Photography  
University Print Collection [ 79.42.225 ]*

under the influence of Anglo culture, larger and more conventional wooden doors and wood-frames, double-hung windows were introduced to Acoma. This altered the original architecture significantly, affecting not only the appearance but also the functioning of the spaces.

Acoma is urban architecture of the highest order. The urban form is an expression of both environmental and social concerns. Blocks of two and three story high houses are aligned to face south to receive the winter sun. On the south side of each dwelling is a roof terrace accessible from the exterior by means of ladders. These terraces were used

## DESIGN FEATURES





*South facing roof terraces at Acoma Pueblo ca. 1935.  
Photo: F. Hannab by permission of Arizona State Museum*

historically as work spaces: here the women of Acoma would sheave and grind corn, weave cloth and make pottery. They could also tend their children in these semi-private spaces, and visit with neighbors on nearby terraces. Thus the architecture of the pueblo provided a supportive environment for a civilized way of life. The whole ensemble creates a balance of community and privacy.

Characteristic features of Acoma pueblo include corner fireplaces, capped with decorated ceramic pots to protect the chimney tops from erosion, and built-in stone benches (*bancos*) at the interiors. The sculptural shapes of the pueblos have captured the imagination of artists and writers from around the world. Among these are counted Georgia O'Keefe, Aldous Huxley and D. H. Lawrence.

Ironically, the forms of Acoma and other pueblos have been popularized as images of southwestern architecture. A stepping parapet with a ladder leaning against it can be found as a decorative feature of suburban houses -- but there are no roof terraces, no shared walls, and no use of natural materials. Stylistic revivalism uses form without substance. It is hoped that the present study will contribute to a greater understanding of the environmental and cultural meanings behind the forms.

## THERMAL PERFORMANCE

Because Acoma is located in the high desert of northern New Mexico at an elevation of 6,000 feet above sea level, winter is the harshest season to address architecturally. Where the architecture of Casa Grande responds primarily to the heat of summer, with small openings, thick walls and a compact shape, Acoma steps toward the south to maximize winter insolation over the stone roof terraces. At the roof level, the builders of Acoma carried the beams over the top of the wall to provide a cantilevered

overhang. This protects the wall from the high summer sun, yet allows the lower winter sun to strike the wall, warming it as a thermal mass. The cross section of a typical dwelling illustrates these attributes.

Among the most effective energy-conserving strategies at Acoma pueblo is the sharing of walls, reducing exterior exposure and the accompanying heat loss and gain. If we consider the efficiency of an enclosure as a ratio of the interior floor area to the exterior surface area, Acoma compares very favorably to a detached house. The typical single-family detached house as illustrated by the base case house at *Ch. 5*, requires 2.3 square feet of exterior surface area to enclose 1.0 sf of interior floor area. A high-density structure such as Acoma requires only 1.0 sf of exterior surface per 1.0 sf enclosed area. This means that the Acoma model is 230% more efficient at enclosing space than detached housing. This greater efficiency translates into construction cost savings and energy savings over the life cycle of the dwelling. Dramatic benefits can be realized from applying this principle.



*Women of Acoma periodically renew the earthen plaster of the mud and stone walls.  
Photo: P. Nabokov, by courtesy of the photographer*

## Tucson, Arizona **ROW HOUSE**

Europeans settled what is now the U.S./Mexico border region during the latter part of the 17<sup>th</sup> century. Following the Pueblo Revolt of 1680, settlers from the Santa Fe area retreated down toward El Paso, and built settlements and ranches along the Rio Grande in Texas and New Mexico. By the early 18<sup>th</sup> century other settlers began following the Spanish missions and presidios along the Santa Cruz and San Pedro rivers in what is now southern Arizona. As towns such as Tucson and El Paso grew, an urban type of dwelling, common throughout Mexico, was built to house these frontier families.

The row house began as a one-room adobe structure, with a front door and one or two small windows. There might have been another doorway opposite on the rear wall, opening to a back yard with a small garden and a few chickens or goats. A corner fireplace would have been the only interior feature. This was the basic dwelling type of the Hispanic settlers of northwest New Spain, now northern Mexico and the American Southwest.

As a family grew and needed more space, additional rooms were built as resources became available. Rooms were added in a linear fashion, eventually forming a row of cellular spaces. Rooms would connect directly to one another without hallways. This is known as an *enfilade* arrangement. Other families would build houses adjacent to an earlier family's complex, often with shared end-walls. In keeping with Hispanic planning principles, these buildings were built to the front property line forming a continuous wall at the street. Originally, kitchens and bathrooms were treated as out buildings. Gradually these functions moved into the house by enclosing rear porches to accommodate them.

Adobe bricks were made on site or nearby. Rooms were spanned with timber *vigas* (beams) and *latillas* (lathing). In the Sonoran desert the lathing for roofs was traditionally saguaro cactus ribs, while in New Mexico *carrizo* (cane) was used. The *latillas* were then covered with up to one foot of earth, the most available material, and drained by *canales* (scuppers). Earthen roofs were not very effective at keeping water out, so a ceiling cloth (a *manta* in Spanish) was attached to the under side of the *vigas* to prevent mud from falling on furniture and occupants. With the arrival of the railroad in the late 19<sup>th</sup> century, imported materials such as milled lumber and sheet metal became available. Waterproof pitched roofs were then added above the original earthen ones.



## TRADITIONAL PRINCIPLES

The row house demonstrates the following principles of southwestern vernacular architecture:

- High-density low-rise construction for efficient use of land.
- Pedestrian scale and density of development produces walkable neighborhoods.
- Passive cooling by cross ventilation.
- Proper orientation of row house facing south will assist passive heating and cooling.
- Potential for shared walls to reduce exposure to elements and reduce construction costs.
- High thermal mass construction (adobe).

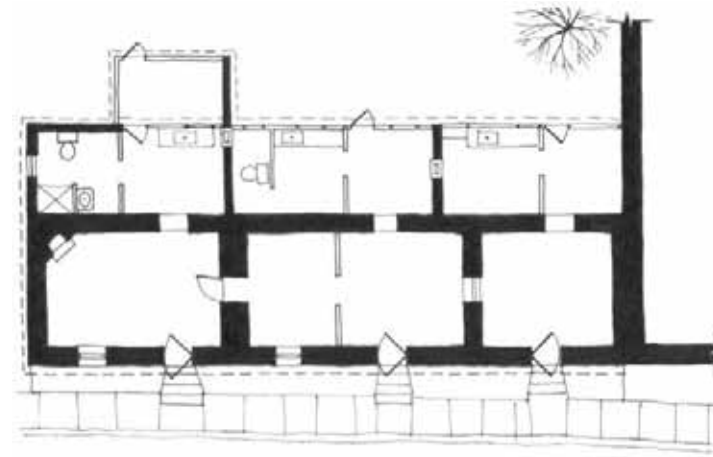

0 10 20  
scale in feet



*Plan, Court Avenue row house, Tucson, AZ*



*North elevation*

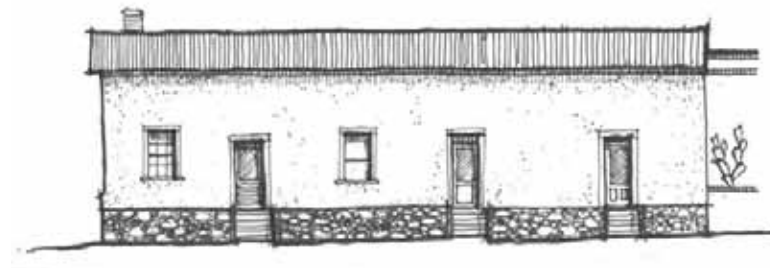

*West elevation*



*Northwest corner: window and door trim color differentiates individual dwelling units. Photo: P. Briggs*



*Adobe row house undergoing stabilization. With plaster removed, large joint in adobe wall is evidence how the building evolved over its 130 year history. Photo: C. Neumann*

## DESIGN FEATURES

The row house is a simple yet adequate dwelling type. Thick adobe walls from eighteen to twenty-four inches thick resting on stone foundations form the exterior walls. Openings are relatively small and have timber lintels, usually of mesquite in Arizona, New Mexico and Texas. Once milled lumber became available, wood casings were placed around doors and windows.

To protect the adobe from erosion, exterior walls were plastered with either mud or lime and sand. During the 20<sup>th</sup> century many adobe structures were plastered with cement, with the intention of reducing the required maintenance of the softer mud or lime plasters. This has proven to be a mistake because the cement plaster, with its hardness

and low porosity, is incompatible with adobe. Cement does not allow adobe walls to transpire moisture, or “breathe”. In recent years, adobe bricks have been stabilized by the addition of asphalt emulsion or Portland cement, varying from 6 percent to 10 percent by volume. Structures built with this type of adobe do not require the usual plaster coating for erosion protection because the material is water resistant and stronger than unamended mud adobe.

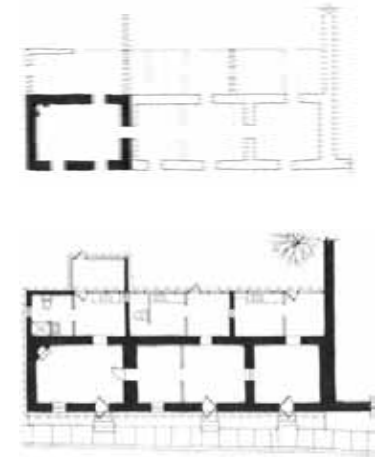

*Plan diagram of growth over time. North unit (top plan) ca. 1870.*

## THERMAL PERFORMANCE

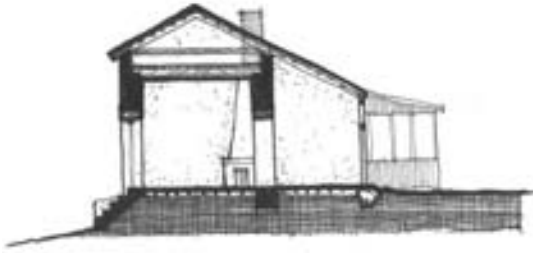

*Adobe row house cross section*

Some new adobe row houses are built with flat roofs with surrounding parapets but rather than soil, they are covered with contemporary roofing materials. They require drains or scuppers to allow rainwater to escape. Pitched roofs, often with sheet metal covering, also are utilized. Rear porches (*portales*) were often added, providing additional shaded outdoor living space. Floors were originally of compacted earth, and later of wood planks on wood “sleepers” (bearing blocks set in the earth). Today, concrete slabs are common.

The adobe row house type offers excellent energy performance characteristics. The adobe walls provide thermal mass, and the pitched roof models provide the possibility of a ventilated attic space with high insulation. If the east and west walls are shaded by porches or trees, or insulated with rigid insulation between two wythes of adobe, the energy performance will be even better. The one-room thick floor plans allow for excellent cross-ventilation, reducing the dependence on energy driven fans and air conditioning. This aspect of the row house type is diminished with the enclosure of rear porches.

Compass orientation is a significant factor in the energy performance of all dwelling types, but especially in this case. The classic row house is an elongated rectangle in plan. Ideally the long axis would run east-west, so that the greatest exposure is southerly. In this way each room can receive direct solar gain in the winter, when it is desirable for passive heating. The narrowest exposures are east and west, thereby reducing heat gain in the summer.

In practice, however, row houses were built to follow street patterns without regard for solar orientation. Many historic examples face west, the least desirable orientation. This illustrates the predominance of culture in building, in which it was considered most important to follow the street pattern, rather than to orient the house to receive favorable sun.



*Tucson, AZ: adobe row house with earthen plaster.  
Photo: C. Neumann*



*Tucson, AZ: thermal performance of individual units of row house is improved by sharing interior walls and receiving shade from adjacent vegetation. Photo: B. Vint*

## Tucson, Arizona **ZAGUÁN HOUSE**

The zaguán house represents a progression in the evolution of the Hispanic dwelling on the northern frontier of New Spain, today's Arizona, New Mexico, Sonora and Chihuahua. As settlements grew into towns, neighborhoods became more dense and contiguous row houses lined the streets. Access to the rear yards of properties became limited. Thus a dwelling type common in other urban areas of Mexico began to be utilized. This type of house has a wide central hall that connects the front entrance with a rear courtyard or patio. Major rooms open from this hallway, which is known in Spanish as the zaguán.

Often the zaguán is wide enough for the passage of a carriage or wagon, and in some urban locations this is the only access from the street to rear accessory structures such as stables. The French porte-cochere, a covered entrance leading to a courtyard, common in Louisiana Creole architecture has a similar function. The main difference is that the French version is usually on the side of the dwelling and is not used as the principal entrance.

The zaguán house also has a counterpart in the 19<sup>th</sup> century central hall house common in the American South, especially in the former plantation regions. However, these examples are usually cottage type dwellings that are raised off of the ground, thus the center hall, being at a higher elevation than the exterior grade, is only accessible for foot traffic.

Research by the authors in southern rural New Mexico revealed a similar house type with a wide central hall that is referred to by the ranching families who built and dwell in them as a “dog-run.” The dog-run is in many respects the equivalent of the zaguán: it is a matter of speculation as to whether the homonyms “dog-run” and “zaguán” are a matter of coincidence, or whether the similarity betrays an Anglicization of the Spanish term.

In the north of Mexico the zaguán house is found more often in urban rather than rural areas, and normally in dwellings close to or facing a plaza.

## TRADITIONAL PRINCIPLES

The zaguán house demonstrates the following principles of southwestern vernacular architecture:

- Compact form minimizes exposure to the elements.
- Pedestrian scale and density of development produces walkable neighborhoods.
- Passive ventilation by means of central zaguán.
- High ceilings permit stratification of air by temperature.
- High thermal mass construction (adobe).

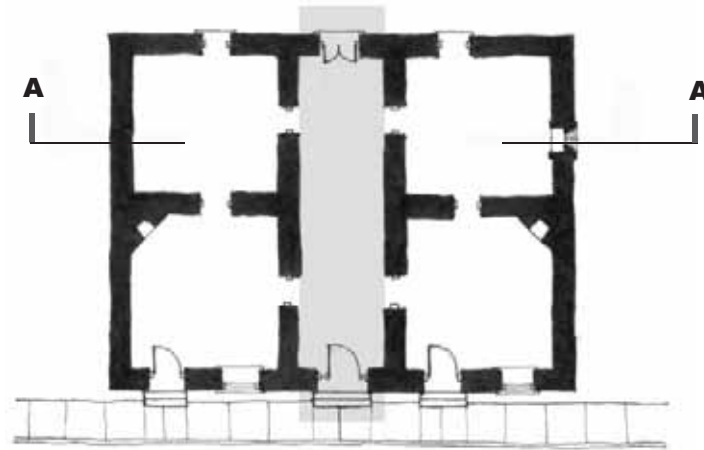

0 10 20  
scale in feet



*Plan, Casa Carrillo, Tucson, AZ. zaguán highlighted at center*

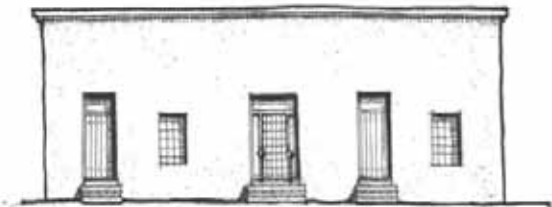

*West elevation*

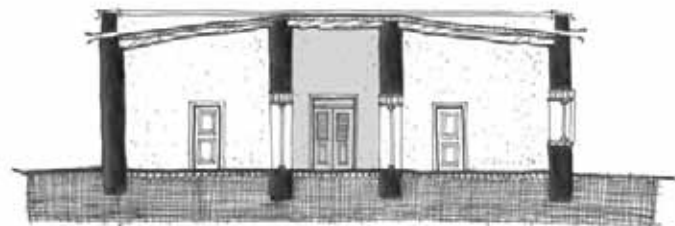

*Section A-A*



## DESIGN FEATURES

With few exceptions the zaguán houses of northern Mexico and the American southwest are built of adobe. The front elevation of the zaguán house is plain, usually finished with stucco, and with little ornamentation. Openings are tall and narrow, and placed symmetrically on both sides of the entrance. The front entrance door is usually reached by steps if the floor level has been raised to accommodate wood flooring placed over an original earthen floor. Occasionally transom windows are placed above door openings for light and ventilation.

The zaguán house has rooms with ceilings of twelve to fourteen feet in height, resulting in parapets sixteen to eighteen feet above grade. The scale of this dwelling type is prominent, and this free-standing plan type was used by the leading citizens of a town.

Vigas span the roof from bearing wall to bearing wall: the length of available timbers determined the sizes of rooms. Originally these dwellings had cactus ribs and soil on



*Tucson, AZ: Zaguán used as sitting room ca. 1890  
E.N.Fish House.*

*Photo courtesy of Tucson Museum of Art*

top of the vigas. Gradually, the exposed sod roof gave way to standard built-up-roof applications. Rear elevations are either flush or have attached porches with sloped roofs. Rooms are at least two deep and are accessed from the zaguán and from each other. Generally, fireplaces are located in corners in order to spare wall space for connecting doors and windows.

## THERMAL PERFORMANCE

Traditionally cooling in the zaguán house was provided by natural cross ventilation. By opening the house at night and allowing the day's heat to escape into the cool night

sky, one can store the night's coolness in the thermal mass of the interior adobe walls. By taking advantage of the dramatic diurnal temperature swings of the hot, high, arid desert, vernacular houses achieved livability.

Heat for the winter was provided by fireplaces located at interior walls to conserve heat and, again, to store the heat energy in the adobe thermal mass.

Because the zaguán house is detached or freestanding, it has relatively more exposed surface area than the row house, which shares walls with neighboring houses. There is thus



*Barrio Viejo, Tucson, AZ: West facade of Casa Carillo.*

*Photo: B. Vint*

*Ures, Sonora: Facade of zaguán house from street. Photo: B. Vint*



greater heat loss and gain. Further, with the zaguán house being two or more rooms in depth, natural cross ventilation is somewhat limited.

Nonetheless, this type of house is a simple rectangular volume, and is more efficient in terms of the enclosure of space in comparison with the more extended courtyard-type house. The zaguán itself serves as an air distribution device, because it connects each interior space and the patio. Traditionally, cool air was drawn from the back garden or patio through the house via the zaguán: the passive ventilation is augmented by heated air rising from the street, creating a convective cycle of air movement.

Zaguán dwellings tend to have darker interiors than row houses due to their greater depth, which is a passive cooling strategy. Direct sunlight contributes to heat gain and in hot months heat reduction is a crucial function of vernacular desert architecture.



*View through zaguán to internal courtyard beyond. Photo: B. Vint*



*Interior of zaguán, which functions as a breezeway. Photo: B. Vint*

## Tucson, Arizona **COURTYARD HOUSE**

The idea of building a house around a *patio*, or open courtyard, originated with the ancient Mediterranean civilizations. Early examples are found from 2,000 to 3,000 years ago in Egypt, Greece and Rome. The concept is to capture a portion of outdoor space by the placement of rooms to define an open-air courtyard. This can be transformed into a micro-climate or oasis, providing both privacy and shelter from the elements. In a hot-arid climate these houses make sense climatically, urbanistically and economically because of their shared walls, self-shading configuration, and efficient land use.

The Romans developed the centralized atrium house as a group of rooms surrounding a small open-air court, often with a central fountain. A loggia, or porch, bordered the court on three to four sides, providing shade. The courtyard functioned as a comfortable outdoor living space, with the sound of water trickling in a fountain. In Roman architecture, these spaces are known as peristyle courts, named for the type of surrounding columns. Within the bustling cities of the Roman Empire, the congestion and noise of the street were shut off from the occupants of the peristyle house.

The Arabs developed the courtyard house in response to the deserts of Arabia and North Africa. Their courtyards were oases of flowering and aromatic plants, together with fountains and pools. Spain received the patio as the legacy of both the Latin and the Islamic cultures. From Spain the courtyard was brought to central Mexico in the 1500s, and then north to the area that is now the U.S./Mexico border region in the late 17th century. In northern Mexico, the courtyard house was employed with great flexibility. There are examples of central courtyards completely surrounded by living spaces, as well as offset courtyards defined by L-shaped houses. There are U-shaped houses, with rooms on three sides of a courtyard.

Historically, the courtyard serves various functions. First and foremost it provides privacy within an urban context, in which the inhabitants can relax, prepare food, keep a few small animals or tend a vegetable garden. The courtyard is in essence a large outdoor room, often the largest room in the house. Being open to the sky, it provides ventilation, bringing fresh air into the interior of the house. The plants and shade serve both to cool and filter the air, as it sinks into the space and flows through the rooms.

Contemporary courtyards tend to be smaller than the historic examples, and are used primarily for outdoor living. They are planted with shrubs, flowers, and small trees, and often have a fountain or pool as the centerpiece of the space. A small house can feel more spacious if each room opens onto a courtyard.



## TRADITIONAL PRINCIPLES

The courtyard house demonstrates the following principles of southwestern vernacular architecture:

- High-density, low-rise construction creates efficient land use, while maintaining private outdoor space in courtyards.
- Pedestrian scale and density of development produces walkable neighborhoods.
- Passive evaporative cooling by creation of oasis micro climate.
- Proper orientation of courtyard facing south or east will assist passive heating and cooling.
- Potential for shared walls to reduce exposure to elements and reduce construction costs.
- High thermal mass construction (adobe).
- Rainwater harvesting for irrigation of courtyard planting.

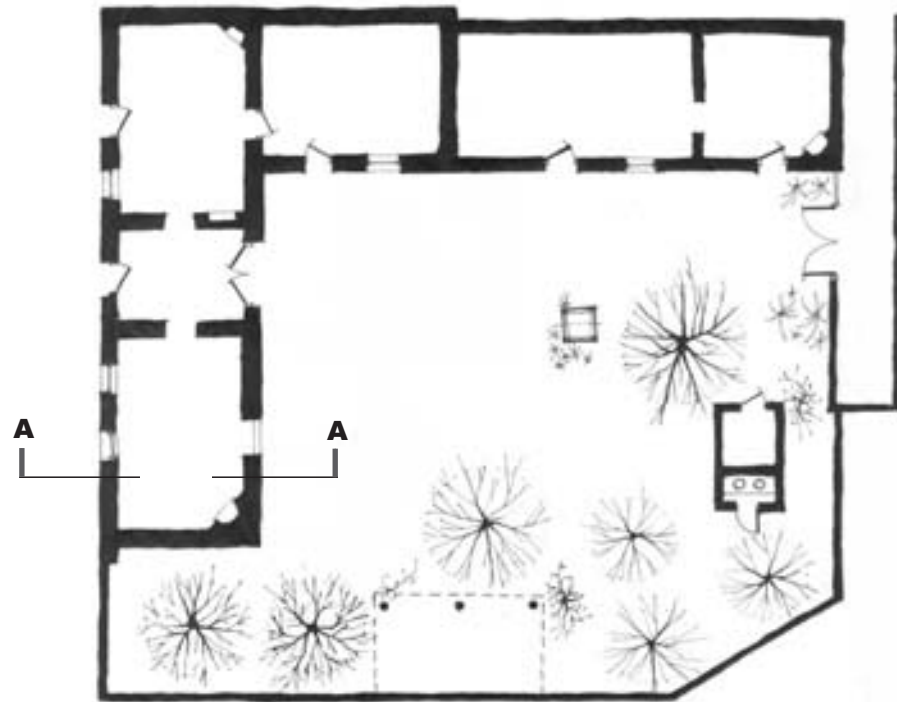

0 10 20  
scale in feet

*Plan, Casa Cordova, Tucson, AZ*

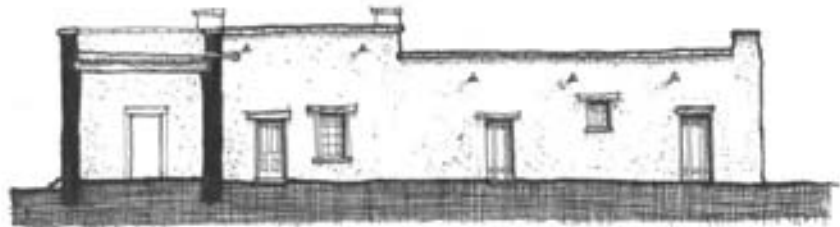

*Section A-A*



*East elevation*

## DESIGN FEATURES

The exterior of the courtyard house is austere, and the house is placed close to the street, much like the row house or zaguán house. The historic courtyard houses of northern Mexico and the American southwest are built with adobe walls, typically having a stone base to protect the adobe from moisture. Although resembling a foundation, the base is often only a layer of stone applied to the wall: often the adobe bricks were laid directly on the ground, or in a shallow trench.

The façade is plain, often plastered with lime and sand, and typically devoid of applied ornamentation. Openings are generally tall and narrow expressing the limits of adobe construction and placed symmetrically about the entrance. Wood lintels of locally available timber, such as mesquite or cottonwood, are sometimes left exposed. Transoms were occasionally used to provide cross ventilation through the entry hall or zaguán. If the floor level has been raised to accommodate wood planks over an original dirt floor, the front entrance door is accessed from the sidewalk by set of steps.



East facade of Cordova House. Photo: C. Neumann

The principal rooms of the courtyard dwelling have high ceilings, often from 10 to 12 feet above floor level, permitting air to stratify within the space. Roofs are traditionally heavy timber-framed, with wood planks or lathing supporting a layer of earth approximately one-foot thick. The roofs are surrounded by parapets, and slope gently to drain through the parapets via *canales* or drain scuppers. Secondary rooms or additions often have lower ceiling heights than the principal rooms, such that roof and parapet heights may be lower over these spaces. Kitchens were traditionally located on the courtyard to allow the heat from cooking to dissipate. Prior to indoor plumbing, latrines were logically located at the far end of the patio.

The courtyard dwelling is typically accessed from the street via a zaguán, which connects to a covered exterior *portal*, or porch, along one side of the courtyard. It can be seen as a hybrid or an evolutionary house form, combining the adobe row-house with a zaguán leading to a patio behind the house.



Cordova House, Tucson, AZ: View of inner courtyard. Photo: C. Neumann

Typically the house surrounding the patio is only one room in depth, so that all spaces open directly onto the courtyard. Some rooms are accessed only from the courtyard, usually via the portal.

When grouped together, such houses create a continuous wall along the street, providing shade for pedestrians. Examples of this type of dense, humane urbanism are found throughout Mexico, and in many of the towns of Sonora, Arizona, and New Mexico. Arizpe, Aconchi, Huepac and Ures are Sonoran towns which typify this approach. The oldest barrio in Tucson, Arizona, and the town of La Mesilla, New Mexico, are examples on the U.S. side of the line.

## THERMAL PERFORMANCE

In the deserts of the U.S./Mexico borderland, the summer's heat is intense, while winters are mild. Hence vernacular houses were adapted primarily to address the hot months of the year, May through October. Traditionally, cooling was achieved by passive methods,

including night time through-ventilation, thermal mass storage, and evaporative cooling by means of the oasis effect. Heating was provided by fireplaces distributed throughout the house.

The courtyard house is built on the oasis principle, creating a garden at the heart of the house. As the dry desert air absorbs moisture from the plants and fountain of a courtyard, it is cooled by evaporation. The sensible heat

of the air is reduced, as its latent heat, in the form of water evaporated, increases. The humidified air feels cooler to the senses.

The zaguán, or breezeway, complements this passive cooling strategy. As cooled air sinks into the patio, it is drawn through the house by passive cross ventilation. For this to function, the rooms must open to one another. The adobe walls provide high thermal mass which tempers the interior environment throughout

the day. People inside the house will feel comfortable even if the air temperature is higher than customary comfort levels, because the body can lose heat by radiation to the cool mass of the wall, as demonstrated by the research in the thermal section of *Ch. 4, Performance*.

Traditional flat earthen roofs provide little insulation and leak notoriously in the summer rainy season. With a pitched wood-frame roof added above the original earth roof, it is possible to create a ventilated attic with space for high insulation. This allows air to move through and carry away heat build-up, with a blanket of insulation laid over the ceiling to reduce heat gain and loss through the roof.

Because courtyard houses have relatively more perimeter wall than simple rectangular houses, there is greater exterior wall area subject to heat loss and gain. This can be mitigated by joining courtyard houses with shared walls, which has the added advantage of reducing construction costs as well.

In the harsh desert summer environment, west facing adobe walls can experience excessive heat gain. This can be addressed within the courtyard by porches or portales to shade the walls. At exterior west-facing walls, rigid insulation can be installed between the wythes of adobe in a double-thick wall.

The benefits of the elongated floor plan include increased natural light and cross ventilation, due to the number of windows and doors and the narrow room layout. The courtyard allows for outdoor living and dining, thus reducing the need for larger interior rooms that would require mechanical heating and cooling.



*Guadalajara, Jalisco: Courtyard provides evaporative cooling with central fountain and vegetation. Photo: B. Vint*

## Tucson, Arizona **CELLULAR HOUSE**

This is one of the greatest buildings in Tucson, Arizona, located at 140 North Main Avenue, and now part of the Tucson Museum of Art. It represents an evolution of traditional architecture in the southwest. It began as a single room adobe house which was joined to a zaguán house, and then continued to grow, room by room, until it formed a U-shaped courtyard house. It can be described as a hybrid house, embodying three distinct vernacular house forms combined into a multi-cell structure.

A cellular house of this nature creates a continuous, dense urbanism. It fills an entire city block from end to end. The buildings are brought to the street front, with private courtyards behind. This is the traditional architecture of Sonora, as witnessed in the towns of the Rio Sonora Valley. It makes a lot of sense for the climate and the culture of the southwest.

When the Fish/Stevens house was built, southern Arizona had only recently become part of the United States via the Gadsden Purchase of 1854. The earliest record of property ownership concerns the purchase of the house in 1862, indicating that it existed prior to that time. Although known by the name of its owners, Mssrs. Fish & Stevens, the house was undoubtedly designed and built by Mexicans. It incorporates the principles of desert architecture as practiced in the mid 19<sup>th</sup> century, and demonstrates that when the first Anglo immigrants arrived in the southwest they looked to Hispanic builders for housing.



## TRADITIONAL PRINCIPLES

- Thick earthen walls for shelter and thermal mass.
- Simple rectangular building forms for ease of construction and structural stability.
- Compact shapes that minimize exposure to the elements.
- Small openings to reduce heat gain.
- Continuous dense urbanism creates high density housing environment.
- Private courtyards provided away from the street.

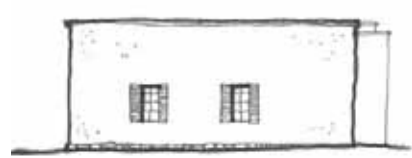

*South elevation*



*North elevation*

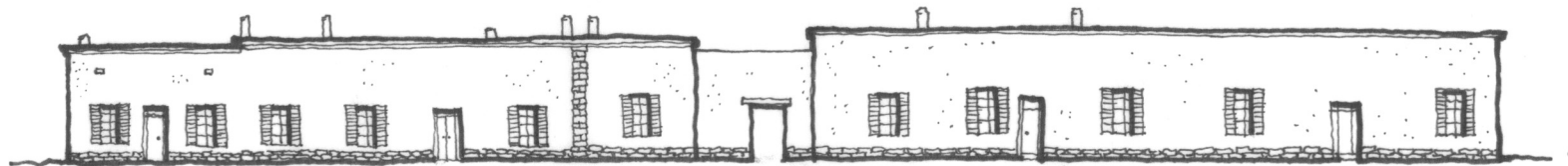

*West elevation*



0 15 30  
scale in feet

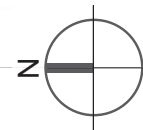

*Plan at present showing Duffield, Steven, and Fish Houses, Tucson, AZ*



*Fish Stevens house, ca. 1870. Photo courtesy of Tucson Museum of Art*



*Shutters and Pepper trees provide shade at west facing wall. Photo: C.Neumann*



## MATERIALS

The walls of the Fish/Stevens house are 24” thick mud adobe, finished inside and out with lime and sand plaster. Foundations are of rubble stone masonry set in lime mortar, in shallow trenches. The roof is framed with squared mesquite wood timbers and wood lathing spanning between. The type of lathing includes both traditional saguaro cactus ribs, and wood slats from packing crates stamped “Edward Nye Fish & Co.” – recycled from the family store for the construction of additions and repairs. Above the lathing is a

traditional earth roof, varying from 9” to 12” thick. In the early 20<sup>th</sup> century a milled 2x4 roof was propped over the original, as was typical in the evolution of Sonoran houses following the arrival of the railroad. This creates a ventilated attic space between the earth ceiling and the sloped modern roof, which is waterproofed with built-up asphalt roofing. Floors were originally tamped earth, later wood, and later still colored concrete slabs. In the northern rooms wood floors remain.

## DESIGN FEATURES

Fish/Stevens exhibits all the characteristics of traditional Sonoran architecture: massive adobe walls for shelter from the extreme desert heat, dramatically high ceilings to permit the stratification of air within the interior (allowing heated air to rise and relatively cooler air to sink to the ground level where people were), small window and door openings to the street, and a garden court behind where the family maintained its privacy. These are all natural responses to the desert.



Fortress-like west wall of Fish House provides an excellent thermal barrier against the desert's heat. Photo: C. Neumann

The resulting building is a massive, simple, rectangular volume, extending continuously along the east side of Main Avenue from Alameda Street to Paseo Redondo. The adobe walls are 18 feet in height at the exterior, and ceilings are 14 feet high. The proportion of the openings is tall and narrow, consistent with the nature of adobe construction. The percentage of solid wall far exceeds the percentage of openings (doors and windows), which speaks of the desire of Tucson's early builders to seek shelter from the sun. Overall, the Fish/Stevens house has a great presence on the street, and a powerful beauty resulting from its unpretentious design.

## THERMAL PERFORMANCE

Since this example includes all the forms of the Hispanic vernacular, it was selected for engineering analysis in the thermal modeling section of this study (see *Ch.4, Thermal Performance*). While the house has the benefit of massive walls and high ceilings, the orientation is a drawback. The house runs north to south on its long axis, meaning that the east and west elevations are exposed to maximum solar gain. This orientation is a disadvantage over the summer months. The house would perform better climatically if it were rotated 90° to run east-west with a long southern exposure. This would be ideal for passive solar gain in the winter months, and present the narrow sides of the house to the most intense sun over the summer. Climate was not the main determinate in the design of this house, as it was built to follow the alignment of the principal street in Tucson, known in the Spanish period as the *Camino Real* (the Royal Road, oriented towards the seat of power in Mexico City). Political organization shaped the urban form, which in turn shaped the architecture.

## Tucson, Arizona **HYBRID HOUSE**

The hybrid house combines the row house, zaguán house, and courtyard house of the Hispanic vernacular with traditional design concepts brought from the eastern U.S. by Anglo immigrants. It is a unique expression of cultural integration in the U.S./Mexico borderland that is not found elsewhere.

With the building of the Southern Pacific Railroad in the 1880s, connecting major settlements between west Texas and southern California, Anglos from the east began arriving in large numbers. They brought with them ideas about building that were combined with Hispanic patterns of house and town making.

Late 19th century Anglo immigrants to Tucson, Las Cruces, or San Diego found an architectural culture in place: the Hispanic tradition of adobe construction, row houses, zaguán entry ways, and courtyards. The established builders of the region were Mexican, building in the common language of the vernacular. The new arrivals wished to include in their dwellings familiar features from “back east,” such as porches with decorative columns, bay windows, and French doors. These combined preferences, along with availability of materials and skilled labor, led to the development of the hybrid house.

The C. O. Brown house in Tucson, Arizona, is a complete example of this house type. It extends full depth in the middle of a city block, fronting on Jackson Street to the south and Camp Street (now Broadway) to the north. Originally it was flanked on each side by similar adobe houses, which have since been demolished. C.O. Brown remains a clue to the vernacular hybrid architecture of central Tucson.

The southernmost section was built in the 1840s, and is a classic three room adobe row house. This portion is the oldest surviving building in the city of Tucson proper (although ten miles south of the city center is the San Xavier Mission and adjoining convento, dating to 1783). The C.O. Brown house grew and evolved over a period of 60 years, through the end of the 19th century when Anglo elements were incorporated.



## TRADITIONAL PRINCIPLES

- Thick earthen walls for shelter and thermal mass.
- Glazed south-facing porch for passive solar gain.
- Passive cross ventilation via zaguán and operable transoms.
- High density, low rise housing environment.
- Private courtyard /oasis provided away from the street.



*Section A-A looking north towards sun space*



*Site plan featuring large interior courtyard*

## MATERIALS

The bearing walls of the C. O. Brown house are of unstabilized adobe. Some sections of adobe were laid on stone rubble foundations, others directly in shallow trenches. That they have endured for over a century demonstrates the durability of adobe when properly built and maintained. The walls are finished with lime & sand plaster, which at the south six-room block has been scored to resemble cut stone blocks with stylized quoins at the corners, a pretension toward elegance in the vernacular.

The floors were originally of compacted earth, then wood strip flooring was laid over sleepers, and later concrete was used

to replace rotted or termite-damaged wood. Several rooms at C. O. Brown retain wood floors dating to the historic period. Windows, doors, and frames are of wood. Some panes of glass display the ripples characteristic of 19th century float glass.

The roof is framed with heavy timbers, including a mix of mesquite and pine and both rough and milled lumber. Above this is propped a lighter framed roof of full 2" by 4" lumber with 1" by 8" planks and corrugated sheet metal roofing. The roof slopes inward to the patio, directing rain water to courtyard planting.



*North elevation (above) and South elevation (below)*



*Views through north building zaguan.  
Photos: C. Neumann*

## DESIGN FEATURES

Similar to its Spanish antecedents, the Hybrid Hispanic/Anglo House fronts the street while accommodating a private courtyard. The moderately pitched roof is concealed by a parapet, and drains to the interior patio.

The original three rooms on Jackson Street were replicated with a second rank added behind them. This created a six room block, two rooms deep by three rooms long. The street wall of this portion is classically balanced: a set of three doors, each centered in the space it serves, with pairs of tall, narrow casement windows placed symmetrically about each door. The exteriors of the windows are trimmed with classical revival elements, the suggestions of flat pediments or cornices.

Attached to this compact adobe box is a continuous wood-framed porch facing an open patio or courtyard. The east and north sides of the patio are defined by an “L” shaped house, which grew from the north to create a generous central compound. The north building is where the fusion of Anglo expectations with Hispanic building practices takes place.

At the north, the C.O. Brown house is held back from the street to provide space for a front porch, an element of the Anglo vernacular. The porch displays Victorian features, such as lathe-turned posts, decorative brackets, and rows of turned spindles under the eaves, indicative of the 1890s time period.

After crossing the wood framed porch, one enters a traditional Hispanic zaguán that passes through the depth of the house into a glazed south porch, another Anglo idea. The south porch is enclosed with double-hung windows placed side by side in the upper two thirds of the space, and vertical bead-board wainscot in the lower one third. The glazed porch acts as a sun room in the winter, when the low sun streams in to warm the space.

Principal rooms have very high ceilings (fourteen feet) and operable transom windows above connecting doors. The long leg of the “L” plan runs along the east, and is one room in depth. This row of rooms has a continuous porch, partly open, partly enclosed with adobe, and partly glazed with wood sash windows. The interior has bead-board wainscoting, another Victorian touch. In this house, one sees architectural ideas and concepts of space from different traditions, such as the courtyard and the porch, joined seamlessly together.

## THERMAL PERFORMANCE

The adobe walls of the Hybrid House provide excellent thermal mass. The linear floor plan allows for cross ventilation. Attic spaces should be highly insulated to reduce heat loss and gain through the roof. A south facing porch will shade the high summer sun, and also allow the lower winter sun to warm adjacent rooms. The porches and courtyard encourage outdoor living, reducing the need for conditioned interior space. There is space in the courtyard for a vegetable or flower garden.



*South facing sun space in north building. Photo: C. Neumann*

## Sonoita Valley, Arizona **EMPIRE RANCH**

One of the truly great vernacular buildings of southern Arizona, the Empire Ranch, dates from the second half of the 19<sup>th</sup> century. The ranch, appropriately named to reflect its enormous size, was originally owned by Tucsonan Edward Nye Fish and included a gold mine called “The Total Wreck.” The cattle ranching and mining operations carried out from this headquarters are emblematic of Arizona’s history over the last three decades of the 19<sup>th</sup> century. The Empire even found its way into the legendary cinema of the American west, when John Wayne filmed *Red River* there in 1949.

The earliest part of the ranch house is the north quadrant where four square rooms surround a central zaguán. This is the purist form of the Sonoran vernacular, and was built in 1871. As the cross-section demonstrates, the building originally had an earth roof over timber beams, above which a gabled roof of milled lumber and wood shingles was added in the early 20<sup>th</sup> century. The original house served as the bunkhouse for the cowboys, as well as kitchen, mess hall, and meat locker. Early history tells of bringing cattle through the zaguán into a closed corral for protection from Apaches. The compact gathering of rooms, which make up the Empire compound, reflects the need for defensive architecture.

The house grew, as did the size of the ranch, with the addition of a wing for offices, a kitchen and cook’s quarters, taking the form of a row-house that extends from the southwest corner of the original house. This was supplemented in 1881 with the T-shaped Victorian addition to the southwest, built by new ranch owner Walter Vail for his bride, Margaret, who traveled west from New England to join her husband. This elaborate addition with its steeply pitched roof was intended to make the western ranch feel homelike for an eastern woman. It is thus a hybrid work combining an imported eastern style with native adobe construction.

Finally, a wood-framed children’s wing was added after 1884 on the southeast corner, adjacent to a covered corral for the family’s horses. The ranch children could open the door from their bedroom, and literally step into the corral to choose a horse to ride for the day.

The walls of the Empire compound are adobe, with the exception of the Children’s Wing, which is wood, framed with shiplap wood siding. This reflects post-railroad construction, and perhaps expresses Mrs. Vail’s desire to create an eastern-style home for her children. The complex follows the pattern of Sonoran earth-roofed dwellings being transformed by the addition of pitched framing lumber roofs above. The upper roofs are finished with a mix of corrugated galvanized iron sheets (known colloquially as “tin roofing”), built-up asphalt roofing (rolled roofing felts impregnated with asphalt emulsion for water repellency), and wood shingles (historically red cedar). Of these materials, the most durable has proven to be the metal.



## TRADITIONAL PRINCIPLES

- Use of building volumes to create sheltered outdoor spaces.
- Porches to shade west side.
- Interior partitions of adobe or similar high-mass walls.
- Combination of heavy and lightweight construction in different areas of house.
- Fireplaces or wood-burning stoves for heating.
- Passive cooling by natural cross-ventilation and high thermal mass.

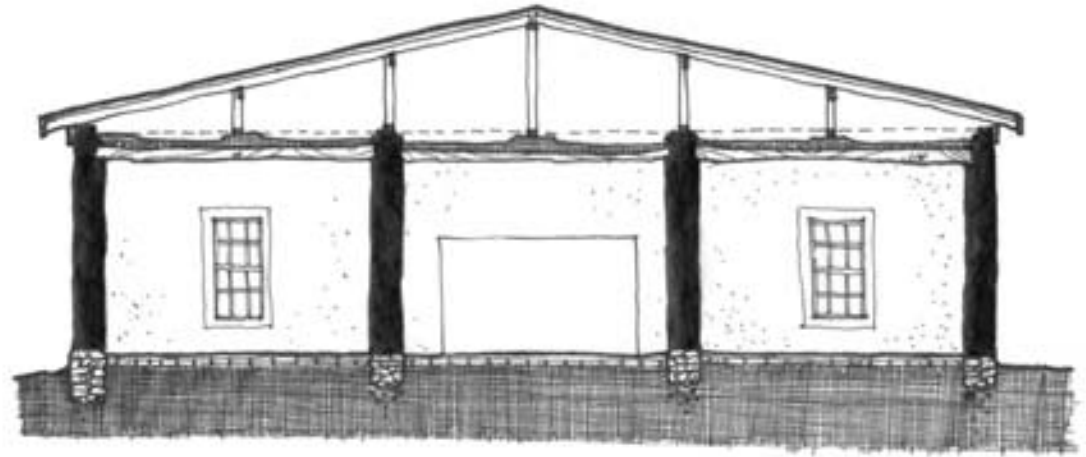

0 8 16  
scale in feet

*Section A-A*



*Tightly grouped buildings constitute the Empire Ranch headquarters in the rolling grasslands of Sonoita. Photo courtesy of Laura Vail Ingram, Empire Ranch Foundation*



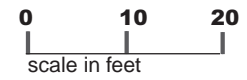

*Plan, Empire Ranch, Sonoita, AZ*

## DESIGN FEATURES

Walls are coarsely plastered inside and out, although historic photos show that the exterior plaster was added late, around the turn of the 20<sup>th</sup> century. Windows and doors are wood framed and painted white. Floors are concrete slabs in the oldest north section (replacing the original earth floors) and 1x4 wood planks in the southern sections. Overall, the buildings follow the Sonoran adobe tradition, with tall

ceilings, high parapets, and simple rectangular forms. Unlike urban examples, however, which have the discipline of street alignments to follow, the Empire grew organically in an irregular pattern. By its form the house creates various outdoor spaces around it. The west side, north of the T-shaped addition, was Mrs. Vail's rose garden. The southeast corner held the horse corral. The

central area was the cowboy's domain, where saddles were stored and the cook served meals. The Victorian Addition and Children's Wing each have porches on the west side. This of course makes a lot of sense to protect the house from the summer afternoon sun. The west orientation is the harshest of all in the desert, and it is an excellent practice to provide shade at the west.

## THERMAL PERFORMANCE

The Empire Ranch house has stood in the high Sonoran desert for over 130 years without the benefit of, and without a need for, artificial cooling. Given the elevation of 4,700 feet above sea level, summer temperatures are approximately 5° to 10° cooler than on the desert floor in Tucson. This makes a great deal of difference in terms of human comfort and people's willingness to endure. With outdoor temperatures seldom exceeding 100°F, interior ambient air temperatures are seldom more than 80°, which is tolerable for most people, especially when an additional cooling effect is achieved by radiation (heat loss) to the cool mass of the adobe walls. To make this effect possible, the interior partitions should be adobe as well as the exterior walls. The combined effect of thermal mass and natural ventilation more easily keeps summer interior temperatures comfortable in rural areas which are naturally cooler due to higher elevation and increased wind speeds. As with most rural vernacular houses, winter interior temperatures at the Empire Ranch are typically below occupant comfort levels, and heating is supplemented with fireplaces distributed throughout the complex.



*Sheltered outdoor space of the Empire Ranch. Note gabled roof framing in progress over original adobe parapets. Photo courtesy of Laura Vail Ingram, Empire Ranch Foundation*

## Animas Valley, New Mexico **GRAY RANCH**

In the far southwest corner of New Mexico, in the area know as the “boot heel,” which juts down beside Arizona, Sonora and Chihuahua, is found the Gray Ranch. In the 1880s a former Texas Ranger and cattle rustler named Michael Gray staked a claim to nearly 500 sections (500 square miles) of open range in the high semi-arid grasslands of the Animas Valley. Gray and his sons ran tens of thousands of cattle (of dubious origin) on this spread, until they were killed by Chiricahua Apaches in the Guadalupe Pass through the Peloncillo Mountains into Arizona.

In the early 20<sup>th</sup> Century, the former Gray Ranch was again homesteaded, this time by several ranching families who built their houses and cowboy camps in remote areas around the ranch. The camps are named for the families that ranched them, or for local landmarks or brands. They have names like Lynch Camp, the OK-Bar, Fitzpatrick’s, Godfrey Camp, Culberson’s (where General Blackjack Pershing set up headquarters in his futile chase of Pancho Villa during the Mexican Revolution), Double Adobes, the Howe, and Upshaw.

The houses were built from 1910 to 1920, and represent a true western vernacular. They were built in extremely remote places by their owners and cowboys, on limited budgets, and with as many local or scrounged materials as possible. To this day, the Gray Ranch is one of the least populated places in the U.S.

To visit the Gray is to travel back in time a hundred years and witness the ingenuity of country people getting by with the absolute minimum of resources. They built simple yet effective houses that yet contain lessons on housing for their environment.

All the houses on the Gray are built primarily with adobe walls, with the bricks made from the building site. This is the most traditional way of making adobes and it is seldom followed today, when most builders import adobes made by machines in an adobe yard. At the Gray, it is evident from the variety of colors and textures that the adobes are as varied as the sites on which the houses stand.

Unlike the Mexican examples, the ranch houses at the Gray have low ceilings. The interiors are typically eight feet to nine feet in height, with gypsum plaster over wood lath ceilings. The motivation for the low ceilings was clearly economy: the builders erected an eight foot high adobe wall, then put a hipped or gabled wood-frame roof directly on the top. The roofs are all framed with milled 2x4’s brought from the railroad to the north. Typical roofing is corrugated galvanized iron. Floors are concrete slab on grade. Doors and windows are wood framed, and of an economical grade. Windows are double-hung single-glazed, sometimes employed lying sideways and operating as sliding windows above kitchen sinks. The architecture is humble and unpretentious, and it works.



## TRADITIONAL PRINCIPLES

- Adobe interior walls for interior thermal mass.
- Porches along one or more sides of the house.
- Ventilated attic space above ceiling, with steeply pitched roof.
- Passive cooling through shaded walls and cross ventilation.
- Wood burning stove for heat.
- Compact rectangular plan shapes.
- Corrugated metal roofing.

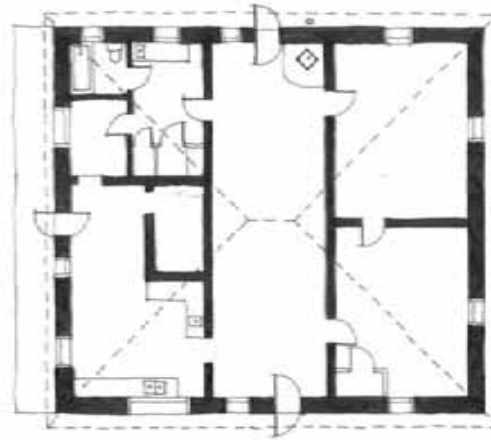

0 10 20  
scale in feet

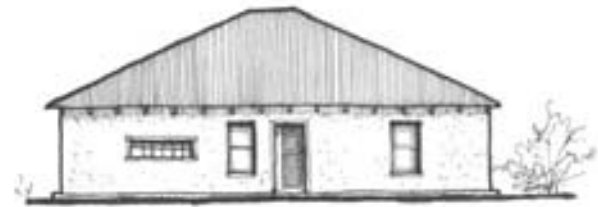

*Culberson House: west elevation (l.) and plan (r.)*

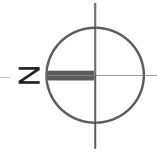

*Lynch Camp, Gray Ranch. Photo: B. Vint*



1. hay barn



2. meat cooler



3. machine shop



4. salt room



5. bunk house

*Culberson Camp, Gray Ranch, Animas Valley NM*



## DESIGN FEATURES

The houses on the Gray began as simple square or rectangular structures of from two to four rooms. The pattern of their growth can be read in the plans. For example, at the Upshaw camp, the original adobe structure was square in plan, and composed of two square rooms beside a long rectangular room that completed the square. The house originally had a pyramidal hipped roof fitting the square plan. Later, low-sloped porches were added along the south and west sides, giving protection to the exterior and creating screened, shaded living space.

As the family grew, a two-bedroom addition was made with cement block walls to the east. As part of this expansion, half of the east adobe wall was removed to permit an indoor bathroom and utility room (prior to which time an outhouse and pump in the yard provided the plumbing necessities). With the addition, the roof was expanded east as a gable, giving the Upshaw an asymmetrical overall roof form. The Upshaw house in its evolution represents several variations on the ranch house.

*Adobe outbuilding with weathered corrugated metal roofing at the Upshaw Camp. Propane is currently used for heating necessities. Photo: B. Vint*

## THERMAL PERFORMANCE

No houses on the Gray Ranch have mechanical cooling. They remain comfortable through the summer months with passive cooling. This is possible at the elevation of 5,000 feet above sea level, where summer temperatures are in the high 80's F and rarely break 100°F. Because of the wide-open spaces of the ranch, all rooms can have windows on two sides, allowing cross ventilation without compromising privacy. Winters are another story: in the high dry savannah of New Mexico's boot heel, temperatures often drop to the low teens in °F. Ranching families used fireplaces and wood burning cast-iron stoves as their heat sources. The Upshaw house is analyzed in its various stages of growth in *Ch.4, Thermal Performance*.



*Upshaw House plan*

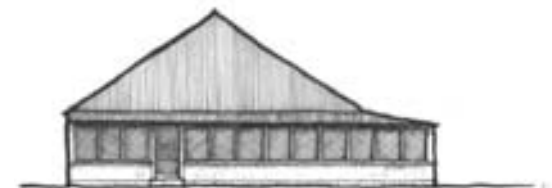
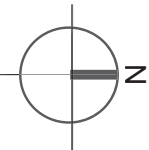

*Upshaw House South (above) and West (below) elevations*



## Tucson, Arizona **BUNGALOW**

The American bungalow was a popular housing type from the 1890s to the 1930s. Its origins are in India where the British adapted the *bangala*, a low-slung cottage found in the Bengal countryside. It became popular as a style with the English Arts and Crafts Movement, and was transported to the United States by proponents of this freestanding and rustic dwelling type. Examples of the bungalow can be found throughout the United States; however, it was in California and Arizona where the majority were constructed. The individual building type was most often placed on its own lot and surrounded by extensive landscaping, but it also lent itself to grouping in the form of U-shaped courts with plentiful shrubs, hedges, flowering trees, and narrow walkways. Once the automobile became prolific, many landscaped courtyards gave way to motor courts. The first motels in America were based on the bungalow court model.

As is typical of vernacular houses, which pre-date the automobile era, there is no provision in the bungalow plan for a carport or garage. Typically, the garage, treated more like a stable, was a separate structure placed behind the house.

## TRADITIONAL PRINCIPLES

The bungalow demonstrates the following principles of southwestern vernacular architecture:

- Deep roof overhangs (akin to the brim of a cowboy hat) shade walls from solar gain.
- Compact plan form minimizes exterior wall area.
- Passive cross ventilation.
- Deep porches provide outdoor living space.



*North elevation*

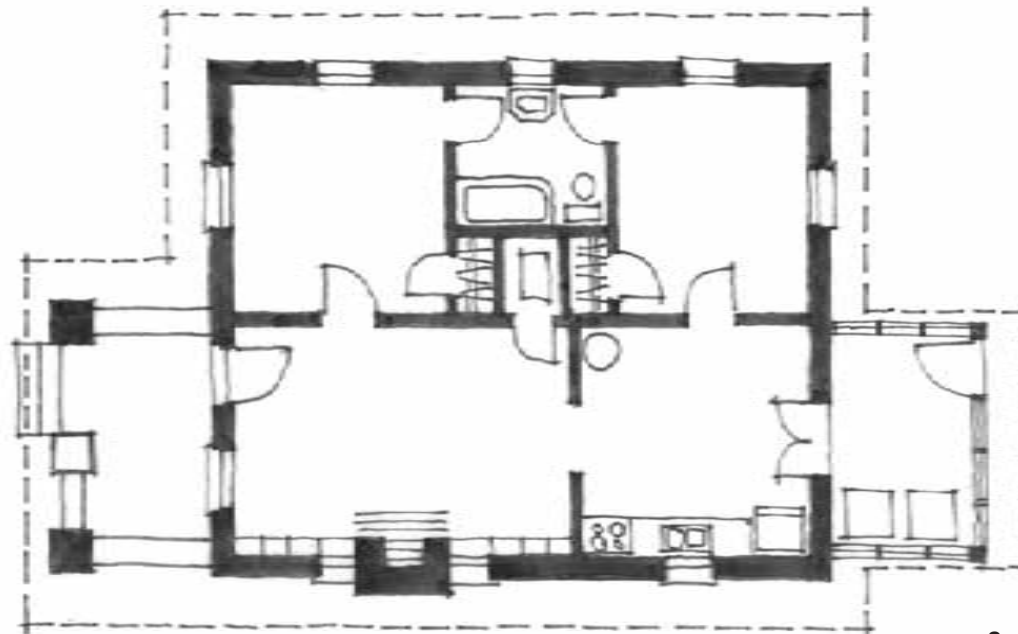

0 5 10  
scale in feet

*Plan*





## DESIGN FEATURES

The bungalow is characterized by a low-to-medium pitched gable roof (occasionally hipped and sometimes with a dormer), wide overhangs, exposed rafter tails, and a deep-set front porch. Roofs are framed with milled lumber and roofed with wood or asphalt shingles. At the porch, massive tapered columns typically flank the entrance steps and support the front gable. In California, most bungalows have wood frame and plaster walls, while in Arizona, New Mexico and Texas, walls are constructed of brick and adobe; both materials usually covered with stucco. Rubble stone was often used for foundation, as well as for the porch columns. The floor plans tend to be one level and more open than their popular predecessor, the Queen Anne cottage. Living and dining rooms are separated by wide openings, some with pocket sliding doors, thus providing a feeling of larger space. Interiors feature the decorative use of wood trim and built-in shelving.

There are examples of two-story bungalows, and, occasionally, a central hall type plan was used. Professional architects designed some bungalows, but the majority were copied from pattern books, and many times these popular and versatile houses were constructed from mail order kits. Many bungalows are very modest homes, typical of the expectations of the time period in which they were built.

During the first half of the 20th Century, the bungalow dwelling type was promoted in various magazines, such as *Western Architect*,



*West University, Tucson, AZ: Set of early 20th century bungalows. Photo: B. Vint*

*House Beautiful, Good Housekeeping, Architectural Record and Ladies' Home Journal.* The style fell from popularity in the post-World War II housing boom, when the ranch home dominated the field. However, the bungalow has continued to be in demand by house restorers up to today, and there is a magazine devoted to this dwelling type, *American Bungalow*. A recently planned energy-efficient housing subdivision on Tucson's far east side, called "Civano," has used the bungalow type in several of its house models.



*Deep porch makes a shady inviting alcove.  
Photo: B. Vint*

*Yuma, AZ: a duplex bungalow. Photo: B. Vint*



## THERMAL PERFORMANCE

The bungalow, with its wide roof overhangs, deep porch, and ventilated attic and crawl space, has architectural features with excellent energy performance for the border regions of the American Southwest. Once again, we see a house type well suited to the desert that is primarily designed to respond to the summer months. This is due to the fact that when these houses were first built there was no electricity available to run mechanical heating or cooling hence the house had to provide shelter and comfort without assistance. The abundance of shade is the greatest single feature of the bungalow in weathering the desert summers, to shelter the building from heat gain. A fireplace was used as the heat source for the winter months.

Windows placed on all sides of the dwelling allow for plentiful natural light, although excessive heat gain from west-facing windows can be a drawback. Wide roof overhangs mitigate this problem. The two to three room deep floor plan limits cross-ventilation, which can only be provided at the expense of privacy.

The bungalow provides an excellent example for today's affordable housing in the southwest border region, when a low-density detached house type is deemed appropriate. The bungalow can be readily adapted to the three principal construction technologies studied in this report: adobe, rammed earth, and straw bale.

# MATERIALS

chapter **3**

adobe, rammed earth and straw bale wall systems  
foundation and roof options

The focus of Chapter 3 is on the material characteristics of traditional and alternative wall systems. Methods of constructing walls of adobe, rammed earth and straw bale are presented and illustrated in depth.

This chapter also reviews options for foundation and roof systems, which are essential considerations in the design of wall systems. Foundation systems considered include traditional stone foundations and contemporary concrete foundations, as they apply to the design and construction of walls of alternative materials. Roof systems discussed include structural framing options, as well as choices for roof coverings.

The review of foundation and roof systems is necessarily limited in scope, as the emphasis of this special study is on alternative and vernacular materials. Conventional foundation and roof systems are widely employed in contemporary construction and are widely known and understood. Hence, less detail is given here on such topics as concrete foundations and metal or asphalt roofing. Such commonly-used materials are the topic of numerous publications and are widely accepted by building code officials throughout the Southwest.

Diagrammatic wall sections are included to illustrate the assembly of adobe, rammed earth and straw bale wall systems. These sections are for general reference only, and should not be applied to specific projects without review by design and building professionals in the locale of the contemplated project. Site analysis is an integral part of the design process, and adaptations may be necessary to address soil conditions and wind or snow loads pertaining to the project location.



Adobe is sun-dried earthen brick, and one of the earliest building materials. There are adobe ruins in Iraq dating back 6000 years B.C. The Maya of Mexico and Central America developed adobe brick prior to the arrival of the Spanish in the early 16<sup>th</sup> century, although the indigenous of what is now the American Southwest did not use adobe until the Spanish introduced the material in the 1600s.

Adobe was brought to Spain by the Arabs during their 800 year occupation of the Iberian peninsula. The word “adobe” comes from the Arabic “al-tob.” From Arabia adobe construction traveled to Egypt, across North Africa to Morocco, and then to Spain. In Morocco the pronunciation of the Arabic word “tob” became “thobe-e,” and finally in Spain it became “adobe.”

Adobe has been used in the American Southwest since the early 17<sup>th</sup> century, when the Spanish first built settlements in northern New Mexico. Many of the Pueblo tribes adopted the material for their own use, as evidenced at Taos. In the same period Jesuit missionaries were building simple hall-style churches in native communities along the Rio Sonora in the northwest Mexican state of Sonora, then the Spanish territory of Nueva Viscaya. In the latter part of the 17<sup>th</sup> Century, Jesuits built mission churches and supporting buildings from adobe in what is now Tucson, Arizona. In their need for expedient shelter, Spanish settlers constructed with locally available materials, turning to adobe for their houses, animal shelters, and other buildings.

The original architecture of frontier towns, such as San Diego, Yuma, Tucson, La Mesilla and El Paso was built of adobe. To this day in the American Southwest, adobe houses are still built, although due to the high labor costs of laying the walls, the cost of building from adobe is higher than that of conventional wood frame or concrete block construction. Ironically, in the U.S., adobe, once the building material of the poor, has become almost exclusively used in custom designed high-cost housing. In Mexico, adobe is still widely used in self help projects.

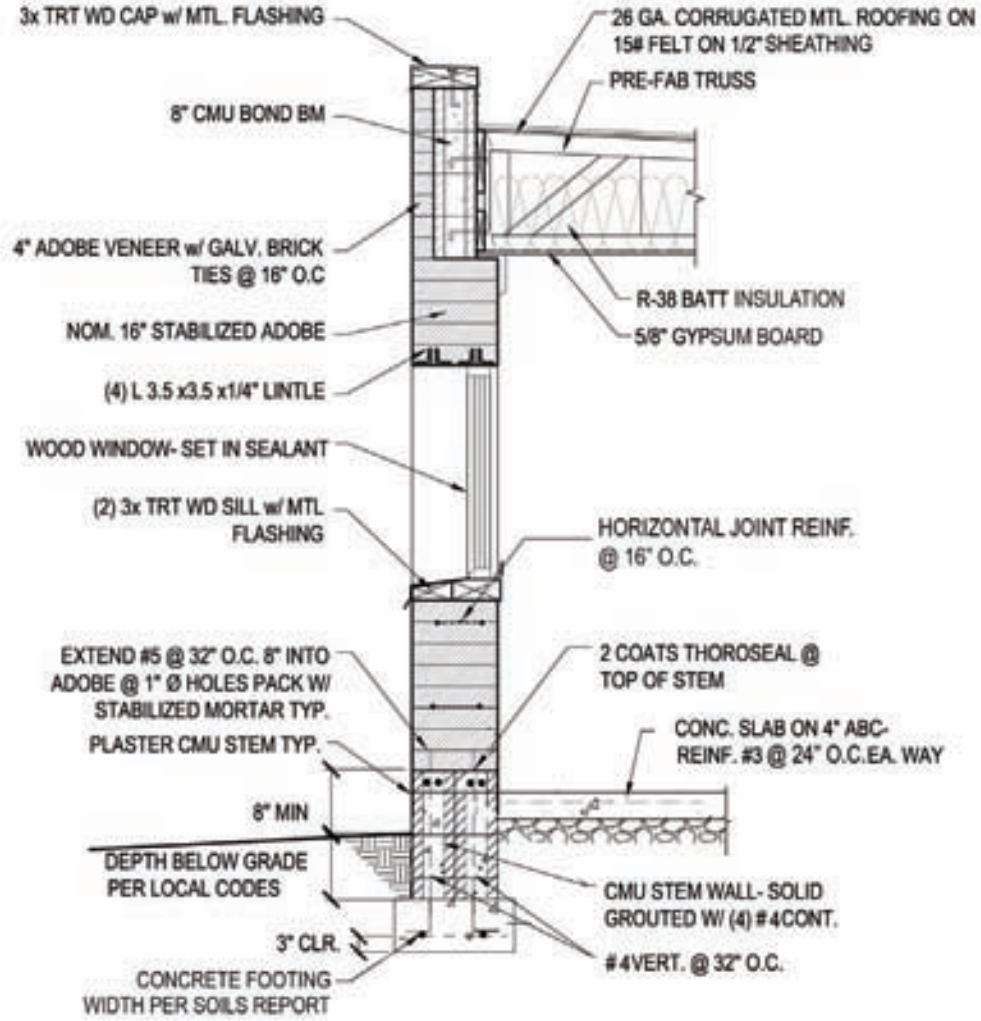

ADOBE PARAPET WALL SECTION

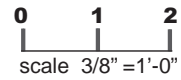

## REGIONAL APPROPRIATENESS

In the making of adobe, earth (composed of sand, silt, and clay) is mixed with enough water to make a stiff mud, which is placed in forms to mold bricks. The bricks, once removed from their molds, are allowed to dry slowly and bake in the sun over several weeks, being turned and stacked to expose the different surfaces to the air and sun for complete drying and curing. Factors such as temperature and humidity affect the requisite drying time. Anyone having spent time in the desert will understand that it really is possible to bake bricks in the sun: the intense sunlight and heat act to harden the mud in a way not possible in cooler, wetter climates. Adobe is truly a material of and for the desert.

A range of sand, clay, and silt is necessary for good adobe soil. Sand grains and silt act as aggregate and filler, while clay is the binder. A wide range in percentages of binder to aggregate can work to produce adequate adobes. There are both scientific and intuitive methods for testing the suitability of soil for adobe, which are well-described in the late P. G. “Buzz” McHenry’s book, *Adobe and Rammed Earth Buildings*. Traditional adoberos use field tests (often taste, touch, and smell) and their personal judgment based on experience to tell if the dirt of a given site is suitable, while geotechnical labs measure particle size distribution, consolidation, compressive and tensile strength, and water absorption through testing.

Many types of soil make good adobes. Fine soils with a high silt content make dense blocks, and require relatively less clay binder

*Cement stabilized adobe wall under construction. Mud mortar has same percentage of cement content as adobe bricks. Straw is added as a nod to tradition. Note 3/8” diameter steel reinforcing bars placed in mortar joint, where a window sill is to be located and additional tensile strength is desired to prevent cracking. Photo: B. Vint*



TABLE 3.1 PARTICLE SIZE CLASSIFICATION

GRAVEL	> 4 mm	> .16 in.
FINE GRAVEL	2 mm - 4 mm	.08 in. - .16 in.
COARSE SAND	500 microns - 2 mm	.02 in. - .08 in.
FINE SAND	250 microns - 500 microns	.01 - .02 in.
FINES	< 250 microns	< .01 in.

*Courtesy of Pattison-Evanoff Engineering, Tucson, AZ*

than sandy soils. Sandy or gravelly soils can work as well, if they have an evenly graded distribution of particle size. Around the world are found endless variations of successful adobe soil.

Traditional adobe makers add chopped straw to their mix for several reasons: first, straw adds tensile strength; second, the addition of straw results in a lighter-weight adobe, by increasing the air space in the earth matrix; and third, straw retains moisture to slow drying time for a more uniform curing period, thereby reducing shrinkage cracks

as the material dries. This is analogous to adding synthetic fibers to concrete for the same reasons, as is commonly done in contemporary practice.

Adobe blocks range from 3 to 4 inches in thickness, from 8 to 14 inches in width, and from 16 to 18 inches in length. A common nominal adobe size in the United States is 4”H x 12”W x 16”L , nominal meaning that the dimension includes the thickness of mortar joints, which vary from 3/4” to 1’ thick. Mortar for laying adobe should be mixed from the same materials used in

making the blocks to ensure compatibility in terms of hardness, moisture absorption, thermal movement, etc. Horizontal joint reinforcement of steel wire should be installed at intervals to provide a measure of tensile strength along the wall.

There are commercial adobe manufacturers across the American southwest in California, Arizona, New Mexico, Texas, as well as throughout Mexico. Unless unstabilized block are requested for historic preservation projects, contemporary manufacturers in the U.S. stabilize their product with Portland cement or asphalt emulsion. Percentages of stabilizer vary with the locale and manufacturer, from five percent to ten percent by volume. Stabilized adobes are resistant to erosion and do not require a protective plaster coating.

Unstabilized adobes are still produced in large quantities in Mexico, but U.S. building codes require that walls made from unstabilized adobe be plastered with cement, which ironically is an incompatible finish for unstabilized adobe, damaging the adobe over the long term: a reminder that building codes are not infallible.

A 20th century innovation in adobe making is the pressed earth block. These can be produced either manually with a brick press, such as the Cinva Ram, or mechanically with a motorized hydraulic brick press. Molding bricks under pressures as high as 30,000 psi results in a denser, more durable adobe weighing 125-135 pcf. Because of their relatively greater density, pressed earth blocks conduct heat somewhat more quickly than traditional adobes.



*Adobe wall under construction in Tucson, Arizona, illustrating the amount of labor required to raise a wall.  
Photo: B. Vint*



## APPLICATIONS

Adobe has been used for centuries around the world. There are examples of multi-story adobe structures in Yemen and Iran. In the U.S. Southwest most adobe construction has been limited to one and two stories, with the exception of some Native American pueblos. Contemporary building codes make it difficult and expensive to build an adobe dwelling of more than one story in height; therefore this discussion addresses the use of adobe for single-story housing.

Building codes in the states of California, Arizona, New Mexico, and Texas now include adobe as an accepted building material, with restrictions. Codes are prescriptive, specifying a minimum compressive strength of 300 pounds per square inch (psi) and wall height-to-thickness ratios of 10:1. Buildings are limited to one story in height unless designed by a professional structural engineer. Adobe may not be used for foundations or basement walls.

The principal advantages of adobe are:

- *thermal mass*
- *high compressive strength*
- *abundance of its raw material, earth*
- *low embodied energy in production*

The thermal mass of adobe slowly absorbs and releases heat energy. In the arid borderlands, summer days are hot while nights are cool, the dryness of the climate permitting the earth to radiate the day's heat into the dark night sky. The night's coolness is stored in the massive adobe walls and moderates the interior temperatures of the



*Effect of cement repairs to adobe: moisture from foundation wicks by capillarity through adobe and is unable to escape through cement stucco. Damp adobe is softened and compresses, pushing stucco off wall; water rises ever higher in wall as further cement repairs are made. The correct finish for unstabilized adobe walls is a "breathing" unamended mud or lime and sand plaster that allows the transpiration of moisture vapor. Photo: B. Vint*



*Long-term effect of cement on unstabilized adobe: deterioration of wall base due to rising dampness trapped by cement. Walls eroded at the base are prone to collapse, when dampened during the rainy season, for they are weakened exactly where the accumulated weight of the wall above is greatest. Photo: B. Vint*



*Adobe house under construction Tucson, Arizona. Note mason's corner story pole and electrical wiring being laid in mortar joint so that interior will not have to be furred out. Photo: B. Vint*

building during the day, thus keeping the occupants thermally comfortable. Equally useful in the cooler months is the ability of the adobe walls to store heat from the sun during the day and release it to the interior during the night. Thermal mass strategy works only in regions where there is a significant diurnal temperature swing, which means in deserts where humidity is low. The ideal thickness of adobe walls in regard to thermal mass varies as a function of elevation of above sea level, latitude, daily and seasonal temperature patterns, precipitation patterns, etc. In principle, the greater the mass, the greater the stabilizing effect on interior temperatures, as with a cave. As a minimum 16 inches of adobe thickness is recommended, for empirical data shows that heat travels too quickly through anything less than that to be effective. A 3-foot thick wall is ideal, but prohibitively expensive to build. A balance must be struck between cost and benefit.

Adobe is strong in compression, making it adequate to resist gravity loads. At 300 psi minimum strength, a 12 inch square pillar is capable of supporting 43,200 pounds of downward load. However, because adobe has no tensile strength, it cannot resist bending, making it vulnerable to lateral forces (i.e. earthquakes.) Given that earthquake loads are a function of the weight and height of a structure, and adobe is a heavy material (approximately 125 to 140 pounds per cubic foot/pcf), earthquakes are often the controlling factor. Engineers calculate both wind and earthquake loads to determine which is greater, and in the case of adobe garden walls, wind load can control the design.

Contemporary adobe construction utilizes a reinforced concrete or steel bond beam at the top of and around the perimeter of the walls to tie the structure together to resist lateral loads. This requirement favors a simple arrangement of the plan, that is, few corners and ins and outs. It is good practice in adobe construction to have frequent cross-walls, also built of adobe, to act as buttresses. The Pima County, Arizona, Earthen Materials Code requires a cross wall at a maximum spacing of 20 feet.

Earth, the raw material of adobe, has the lowest possible embodied energy content of known building materials, that is, the least energy is required for its production. Adobe is a recyclable material, as it can be dissolved back into the earth. True adobes are dried naturally in the sun, another source of unlimited and free energy. Therefore, the largest cost of adobe manufacturing and construction is human labor.

Research by Professor Gernot Minke of Kassel University has shown that the production of industrially manufactured building materials uses a high amount of energy (refer to Table 3.2). Earthen materials consume only about one percent of the energy required to produce burnt bricks or concrete elements. A further reason to consider earthen construction, beyond its energy efficiency and low life cycle operating costs, is the benefit to the environment of consuming less energy in its production.

In northern Mexico and the southwestern U.S., there is a regionally available material called “burnt adobe”, a contradiction in terms, since adobe means unburned brick. In

New Mexican Spanish, burnt adobe is known as *adobe quemado*, while in Sonora it is called *tabique* or *ladrillo*, meaning brick.

Burnt adobe is in essence a primitive brick the same size and shape as a mud adobe block. The same mud bricks used unfired as adobes are placed in a kiln and fired, achieving a

degree of ceramic vitrification. Because adobe mud is low in clay content, burnt adobe bricks do not achieve the strength of fired clay brick (600 - 900 psi for burnt adobe vs. 6,000 psi for clay brick).

**TABLE 3.2 ENERGY EXPENDITURE OF BUILDING MATERIALS**  
( Kilowatt hours per cubic meter)

<i>MATERIAL</i>	
Steel	54950 kWh/m <sup>3</sup>
Timber	550 kWh/m <sup>3</sup>
Concrete	500 kWh/m <sup>3</sup>
Precast concrete	800 kWh/m <sup>3</sup>
Perforated brick	600 kWh/m <sup>3</sup>
Solid brick	1 100 kWh/m <sup>3</sup>
Earth (adobe, rammed earth)	5 -10 kWh/m <sup>3</sup>

*Source: Minke, Gernot “Earth as a Building Material” Out of Earth, First National Conference on Earth Buildings Center for Earthen Architecture, University of Plymouth, UK 1994.*

Burnt adobe or *tabique* was popular in Arizona and New Mexico from the 1930s through the 1960s as a locally made, economical alternative to brick, cement block or wood frame construction. It fell from use in the 1970s, as the costs of masonry labor began to escalate, and wood frame and stucco became the least expensive and most widely used method of construction.



*Eric Means, mason and general contractor, installs a reinforced concrete block (CMU) bond beam at roof level of adobe wall. Photo: B. Vint*

Kilns for burning *tabique* are fired with whatever fuel can be gathered in the small villages where these bricks are made. This has led to the deforestation of mesquite bosques in northern Mexico, and the burning of rare ironwood trees along with mesquite. As brush for fuel grows scarce, some fabricators have turned to burning car and truck tires in their adobe kilns, with environmentally disastrous results. Burnt adobe is not recommended for use in the construction of new dwellings, as sun-baked adobe is environmentally more appropriate.

### APPLICATIONS

The greatest limitation to the use of adobe for affordable housing is its relatively high cost in comparison with conventional construction methods. In 2004, the regional cost per square foot (PSF) of wall area was approximately \$18.00 for unplastered adobe, compared with \$12.00 PSF for an insulated, plastered concrete block wall and \$8.00 PSF for a frame/plaster wall. Cost is a significant obstacle to the use of adobe for affordable home building, due to its labor intensive nature.

Another factor in the cost of adobe is that a limited number of masons are experienced with the material. If the labor pool were to grow, competition would reduce costs.

A way to make adobe feasible for affordable housing is to share walls between units, in essence, building a wall once and using it twice. This effectively cuts the cost of the wall in half, making it more competitive with conventional materials. Shared walls have the added advantage of reducing exposure to the elements, reducing both heat loss and gain,

resulting in lower air conditioning loads and utility costs. With the higher densities made by the courtyard type house, land use is also more efficient as more houses can fit in the same land area. This reduces the cost per house, as the land cost is distributed over a greater number of houses.

Another approach is to design smaller houses of higher quality in terms of energy performance and durability, considering not only the first cost but the life-cycle cost of operating the house. In this aspect, adobe is superior to conventional methods of construction.

Using stabilized adobe which does not require exterior stucco or interior fur-outs (wood or metal framing added inside masonry walls to create a cavity for insulation and wiring) is also a cost reducer. With exposed stabilized adobe, the mason (1) builds the structure, (2) creates enclosure, and (3) provides a wall finish all in one operation. No framers, drywallers, plasterers, or painters are needed.

All of these factors must be considered in determining the total cost and benefit of adobe construction. Between shared walls, courtyards, lower land costs per dwelling, greater durability, and lower life-cycle costs adobe can be feasible for use in affordable housing. Housing design based on these principles requires special planning and understanding to maintain privacy and quality of life. In *Ch.5* of this report are prototypical designs demonstrating this concept.

Rammed earth is among the oldest building materials and methods. Over 6,000 years ago in ancient Egypt, rammed earth was used to fill the great pyramids. The Great Wall of China is largely rammed earth, again with a stone veneer facing. In the southwestern deserts, the Hohokam site of Casa Grande in central Arizona has stood for over 650 years as an example of the durability of earthen construction. By mixing dirt with water and compacting it in forms, the earth itself can be molded into enduring, energy-efficient architecture.

Contemporary rammed earth practice is a mechanized form of achieving an earthen wall. It is in essence industrialized adobe. Earth is dampened to optimum moisture content, which is the point at which no additional water can be added without creating mud. Damp earth is placed inside a braced formwork of wood or steel, and compacted with either hand-tamping rods (also of wood or steel) or pneumatic compressed air tampers.

The earth is rammed into the form until it is fully compacted, at which point it rings in a distinct way discernible to the experienced earth-rammer. Testing of samples taken from the field by a certified testing laboratory is recommended, as described in *Cb. 4*. Because the earth is well compacted and is typically stabilized with a small percentage of Portland cement (3% - 5% by dry volume), it can be left exposed with greater durability than adobe. It reliably attains the minimum compressive strength of 300 pounds per square inch required by building codes. Rammed earth is a superior thermal material when compared to concrete or cement block, and can be a very environmentally responsible option. The amount of energy required to produce a cubic meter of rammed earth is only one percent of that required for the same volume of concrete or brick (*see Table 3.2, p. 87*).

Rammed earth houses in hot-arid regions rely upon the "thermal fly-wheel" principal of using the massive wall to moderate the extreme diurnal temperature swings typical of deserts, as described in the preceding section regarding adobe. To function properly for passive cooling and heating, earth buildings require natural cross ventilation.

Because rammed earth cannot be vertically reinforced with steel reinforcing bars like concrete block, it remains vulnerable to earthquakes. A sound design approach including a maximum wall thickness-to-height ratio of 1:10, adequate cross-walls, and a continuous bond beam is needed to provide adequate resistance to lateral forces.

As with adobe, North American building codes require concrete bond beams for rammed earth walls, although extensive seismic testing in Latin America has shown that wood bond beams are more compatible with earth. The problem is ensuring that the wood is protected from insects, moisture and rot, so that it remains effective. The same is true for bearing lintels in earth walls: current U.S. codes disallow wood lintels in masonry walls of any kind.

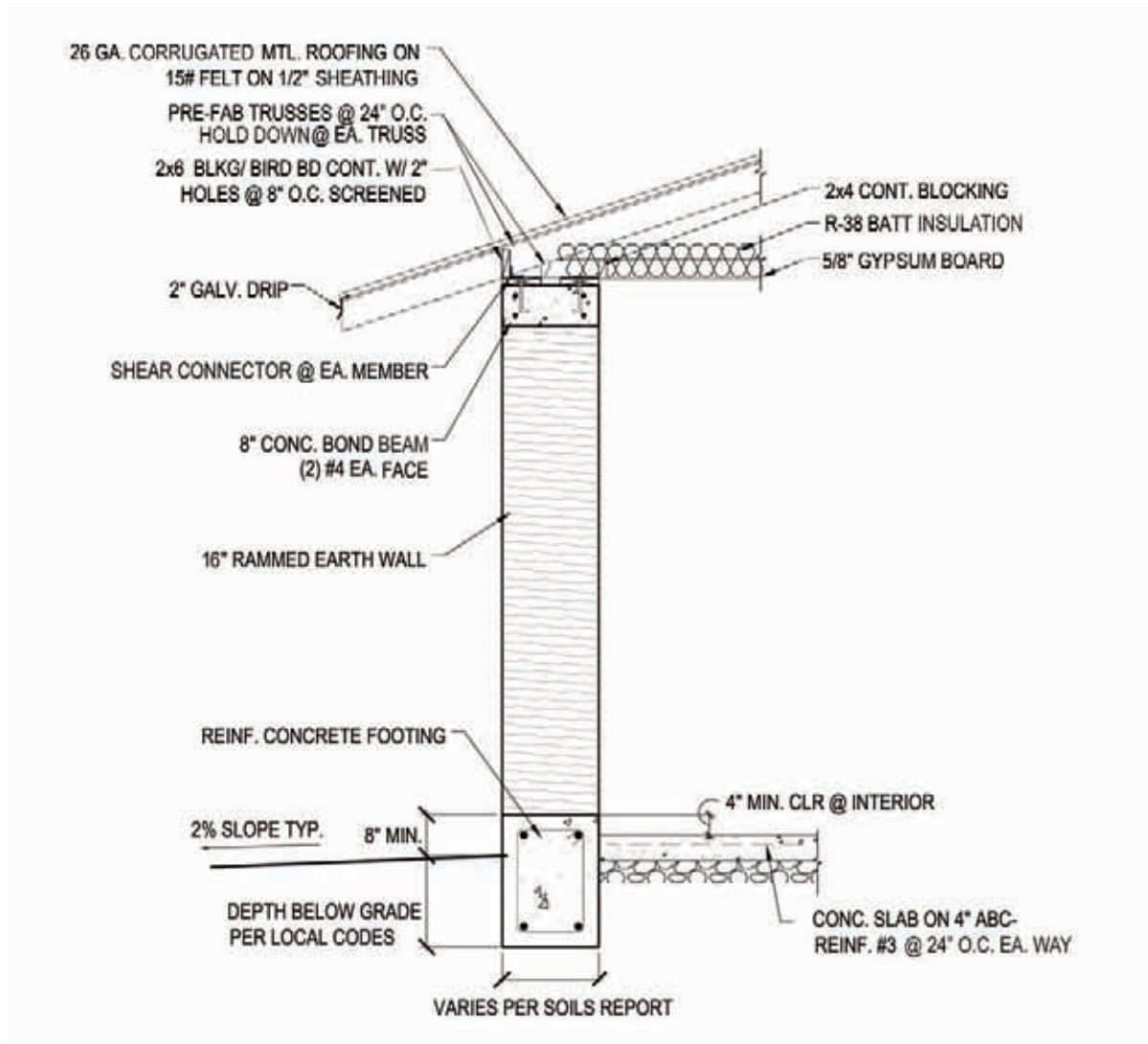

RAMMED EARTH WALL SECTION

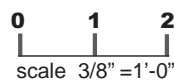

## AFFORDABILITY

Although taking advantage of modern mechanized techniques, rammed earth is surprisingly 25 percent more expensive than traditional adobe construction. In 2004, a two-foot thick rammed earth wall constructed by a specialized subcontractor cost from \$20 to \$24 per square foot of wall surface area, depending upon the height. Walls greater than 12 feet in height cost more than lower walls due to the cost of additional formwork and labor to place the earth.

This means that professionally contracted rammed earth costs two to three times more than conventional wall materials, such as wood frame or concrete block, making it prohibitively expensive. *Only through donated or subsidized labor can this material be considered for widespread use in affordable housing.* An example of this approach is illustrated in the case study which follows this general discussion of the material's properties and limitations.

Another possibility is to use rammed earth in limited ways to make the most of its thermal properties, such as building a single rammed earth wall to act as a thermal mass within a house built largely of other less expensive materials, such as straw bale or wood frame.

Rammed earth may also be used to build benches beneath south-facing windows, to absorb the sun's heat and re-radiate it at night for passive solar heating.

Earth walls can be left exposed, both saving the cost of finish plastering and revealing the aesthetically pleasing pattern of striations of earth as rammed in successive layers.

Ironically, rammed earth has become a

material of choice for wealthy people in the building of their "dream homes." Earth, the humble material used to house the world's poor for centuries, has become a luxury in our contemporary society.

The great difference is that the poor who build their own shelters out of earth do so with their own labor. In a cash-based economy, self-sufficiency is exchanged for specialization, and given the relatively high labor costs of an industrialized society, traditional earth construction costs more than building with modern materials.

## APPLICATIONS

The ideal wall system for a desert house would have high thermal mass, low thermal conductance, and substantial thickness. Rammed earth fits this description well.

To achieve the thermal benefit of rammed earth the interior surface of the walls should not be furred or insulated, as this would isolate the thermal mass from the living space. Electrical and plumbing lines must be integrated in the earthwork, increasing the cost of these sub-trades.

Ideally the exterior of an earth wall would be insulated and plastered, for this protects the thermal mass from temperature extremes and stabilizes the temperature of the thermal mass. As with adobe, the exterior finish employed with rammed earth must have a "breathing" surface so as not to trap moisture within the wall. If a contemporary foam and synthetic stucco "Exterior Insulation and Finish System" (EIFS) is considered, its permeability and compatibility with an earth

substrate must be confirmed. Manufacturer's product data should include test results demonstrating breathability.

Because rammed earth is produced in large, box-like forms, the system favors straight simple walls with few corners. This produces simple rectangular buildings in the tradition of Casa Grande or Sonoran adobe row houses.

Rammed earth is an excellent material due to its durability, high thermal mass, and aesthetic appeal. It is a regionally appropriate, yet costly, material. In order to make use of rammed earth for affordable housing, innovative programs, such as that outlined in the following case study, must be employed.

*Striations of rammed earth in approximately 8" lifts.*  
*Photo: C. Neumann*



## THE GILA RIVER RESIDENCE

### architect/builder

1999 Design/Build Studio University of Arizona College of Architecture and Landscape Architecture in partnership with the Gila River Indian Community (Akimel O'odham)

### location

Gila River Indian Community, District 6

### clients Della Hughes Family

### residence area 1120 sf.

### final cost \$51,000 (2001)

\$4 psf rammed earth cost due to use of homemade forms and student labor, \$9 psf when student labor paid at minimum wage.

Funded by UA/ Community Partnership Grant from the Kellog Foundation

The University of Arizona College of Architecture Design/Build Studio, run by Professor Mary Hardin, has been taking on the challenge of engineering rammed earth construction such that the process becomes more affordable to low/moderate-income families. The high cost of rammed earth results from the overhead expenses of formwork and scaffolding, as well as the greater labor required to place and compact large volumes of earth into the forms. The Studio's interest in experimenting with rammed earth led to a partnership with the Gila Indian River Community, which was facing a housing shortage.

The result of the partnership is the Gila River residence, a rammed earth house designed and built by architecture students at the University of Arizona. In working with Gila River tribal members to train them in rammed



Della Hughes with her family's "sandwich" wall home in background. Photo courtesy of J. Florence

*"The family claims that this house has some of the desirable attributes of their traditional architecture, because it maintains a constant interior temperature while using naturally available materials. The community response has been strong and more rammed earth houses are in the planning phase."*

Prof. Mary Hardin

"Appropriate Technology: Cycling Between High and Low Tech in the Sonoran Desert"



UA design/build student ramming earth with a pneumatic tamping machine known as a Jumping Jack. Note custom lumber formwork. Photo courtesy of M. Hardin



A tribal member smooths the concrete bond beam where the roof assembly will be connected to the earthen walls. Photo courtesy of M. Hardin





**1** *Mixing dry soil and cement.*



**2** *Tamping earth within lumber/plywood forms.*



**3** *Removal of forms.*



**4** *Tamping higher portions of wall.*



**5** *Work progressing from building corners.*



**6** *Forms built to create voids for windows/ doors.*



**7** *Concrete pumped into forms for bond beam.*



**8** *Sills protected with tile.*



**9** *Final earthen house before windows and doors.*

## THE BUILDING PROCESS

*All photos on this page courtesy of M. Hardin and J. Florence.*

earth construction, the students learned of traditional Akimel O’odham building techniques such as the “sandwich house.” The sandwich house, with walls composed of mud and straw packed into a frame of heavy vertical posts with light horizontal pieces, has been popular for 80 years, but requires a lot of maintenance.

The native use of compacted earth dates back to the construction of Casa Grande (see Ch. 2, Design). The tribe was interested in continuing their earth building traditions, but with a more permanent product. Densely compacted cement stabilized rammed earth was considered a very viable solution.

After students met with the client family and other tribal members to decide the house configuration and the best way of using the local soils, construction began. The earth

wall forming process was streamlined by the investigations of previous UA Design/Build studios. Rammed earth contractors typically form an entire building at once and do the tamping in the shortest possible time to reduce labor costs. In the case of this non-profit partnership where labor was plentiful and cheap, an alternative forming system was pursued in which walls could be formed incrementally by a few people and the forms reused again and again.

Previous testing ruled out the use of forms similar to those used for contemporary concrete work (plywood sheets reinforced with steel members), since they were not easily used on a small scale. The weight of the forms and difficulty connecting courses led the design team to try other options. Another attempt using plywood reinforced by aluminum members was not successful,

since the forms moved under the force of pneumatic tampers and caused the walls to “creep” horizontally or “crawl” vertically off the foundation. Finally, the Studio reverted to an established forming system involving planks reinforced by poles and ropes. Quick and easy assembly was the benefit of a system in which milled lumber stiffeners (2x10 walers) were held against plywood forms by pipe clamps to retain the tamped earth. In a previous UA Design/Build project (a 1000 sf rammed earth classroom built in 1998), this two-person incremental forming system cost just \$300 for plywood, boards, and pipe clamps.

With the Della Hughes house the forming system was further improved for a small labor force. Breakdown and set-up periods were reduced by using 4’ x 10’ sheets of plywood with no alterations, except for the holes drilled for pipe clamps. Previously, forms were raised in 2 ft increments: fewer clamps were needed in this case since the seam between forms was eliminated by the use of a higher form. In addition, PVC tubes were used as sleeves for the pipe clamps and wedges/shims were developed to resist the increasing pressure between forms and clamps as the earth was tamped. The PVC sleeves were left in place as conduits for snap ties which held together the plywood forms for the concrete bond beam at the top the walls.

This family has been satisfied with their rammed earth house, made possible by the work and dedication of the University of Arizona Design/Build team and the Gila River tribe. Rammed earth is feasible for affordable housing through donated labor or sweat equity on the part of the owners.



The Della Hughes Family House after rough work (walls and roofing) has been completed. The wide porch which shades the south and west side of the residence aids in passive cooling and provides the family with outdoor living space. Photo courtesy of M. Hardin



Saguaro ribs integrated into the rammed earth during tamping and anchored by 3” drywall screws and inset on the sides by 12”. The addition of the ribs was debated between students and tribe members since its function is purely ornamental but tribe members deeply wanted to maintain ties to traditional sandwich wall construction. Photo courtesy of M. Hardin

Straw is the stem material left as a by-product of modern grain harvesting. A common misconception is that straw and hay are the same but they should not be confused. Hay is grown for livestock feed and harvested green, while straw has no nutritional value and is therefore not as susceptible to rot or insects. When properly designed and constructed, straw bale is a viable and sustainable building system.

When harvested, straw is compacted into modular forms and bound with baling wire, sisal or propylene twine to form bales, allowing it to be removed from the fields and stored. There is an abundance of straw across the United States: it is estimated that 140 million tons of loose straw are created in the US every year (Myhrman and Knox, 8).

A relatively short time elapsed between the invention of the mechanized baling and the use of straw bales to build shelters. Midwestern homesteading drove the great agrarian boom of the late 1800s, bringing with it western migration and the invention of machinery to serve the new agricultural society. By 1872, the stationary horse-powered baler was used to produce straw bales. A steam-powered baler was available by 1884. Straw was initially baled as a means of managing it and moving it with machinery, rather than with manual labor (pitch forks and wagons). Straw had to be removed from fields after the harvest, and was useful as animal bedding and floor covering in stables.

For early settlers in the harsh climate of the Nebraskan plains, baled straw was a natural choice as a readily available, economical and highly insulating building block. Settlers recognized the ability of straw bales to retain warmth and provide protection from the elements. Straw bales were stacked with staggered joints like brick construction. The roof was set directly atop the bales. This method of construction is called the “Nebraska style” after its place of origin. Nebraska style is simpler than the “Post and Beam” system, in which bales are fitted into a wood or steel framework.

In addition to housing, straw bale construction was used for farm buildings, churches, schools, and stores. Shelter options for early Great Plains settlers were limited. As the plains have no forests, it was difficult to obtain wood for building houses before rail lines were built to import materials. Sod houses made from layers of cut turf were built, but this method required more labor than building with bales, and stripped productive land of its top soil. Although early straw bale houses were likely intended only as interim shelters, their insulating performance in the extreme temperatures of Nebraska’s blizzards proved so effective that many became permanent dwellings.

According to straw bale experts Matts Myhrman and Judy Knox, at least twenty-eight original midwestern straw bale structures dating from the 1890s to 1930s still exist. Many remain in good condition despite receiving little maintenance. The Scott House is an example of the endurance of a properly built Nebraska style straw bale structure. Built in the 1930s of wheat straw baled with a stationary horse-powered baler, this 900sf house is still lived in by the daughter of the original builder. She recalls her mother objecting to the thought of living in a house made of straw, but once construction was complete, she became convinced. She also reports that her utility bills are 40 percent lower than her neighbor’s.



*Arthur, Nebraska: The Martin-Monbart house, built 1925. The house has become a family museum and is open to visitors.  
Photo courtesy of M. Myhrman and J. Knox*



*Huntsville, Alabama: The Burritt Museum, built in 1938, is a post & beam style straw bale. The structural system is concrete.  
Photo courtesy of M. Myhrman and J. Knox*



*"Bailing hay on the Empire Ranch, Buffalo County, Nebraska." 1907 Photo: Solomon D. Butcher, US Library of Congress*

Over the forty years following the formative period, straw bale construction declined with the advent of other affordable housing choices, including manufactured housing. It was not revived until the early 1970s when it was “re-discovered” by hippies moving back to the land. Straw bale housing was profiled in the alternative housing publication *Shelter*, published in Berkeley in 1973. From that date forward, straw bale has experienced a renaissance in the US Southwest. In 1991, the first legally permitted, insured and bank financed “Post and Beam” straw bale house was completed by owner/contractor Virginia Carabelli in Tesuque, New Mexico.

Two years later the first permitted load-bearing Nebraska-style straw bale house was completed in Tucson, Arizona, by Judy Knox and Matts Myhrman. Myhrman and Knox worked closely with David Eisenberg, director of the Development Center for Appropriate Technology (DCAT) of Tucson in developing the Pima County, Arizona, Straw Bale Code. This has become a model code for other southwestern municipalities.

Straw bale residential construction has spread world-wide, from Canada to Australia and from Mongolia to Mexico. There have been many new developments in the straw bale construction from the mid-1990s onward and interest continues to grow as its affordability, environmental advantages and aesthetic values are recognized.

## BALE TYPES AND PROPERTIES

Straw is inherently structural, and maintains its form because of its tubular shape. The material's microscopic waxy coating also makes it slightly water resistant.

A straw bale is a bundle of straw bound with baling wire or polypropylene twine. Sisal has also been used for binding in the past but is not rot resistant. Straw varieties include wheat, rice, barley, hops, and oats. There are two types of bales, 2-string and 3-string. A diagram of each is at right. Bale sizes vary depending on the type of baler used and local practice. Bale weight may also vary, depending on density and moisture content.

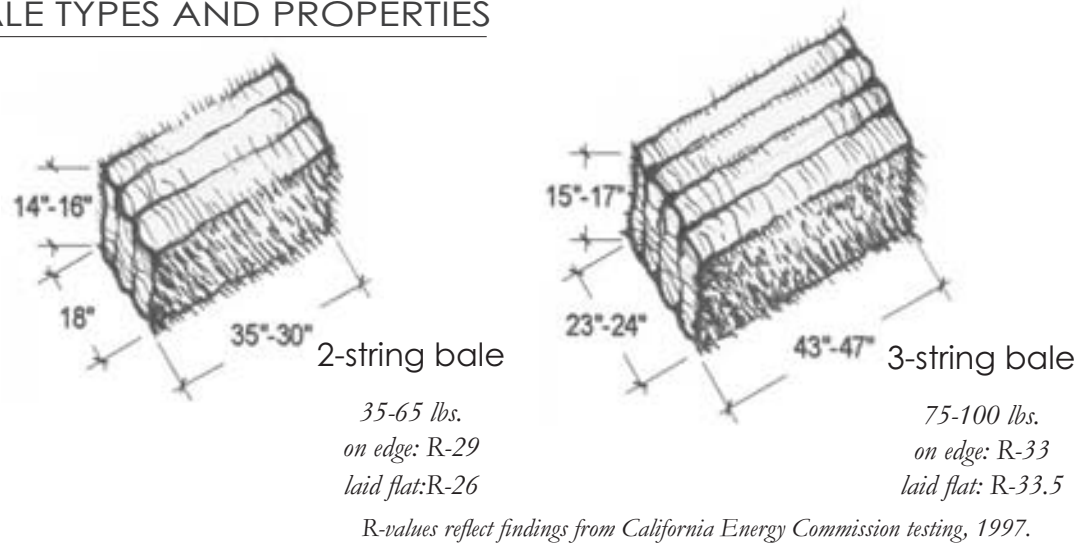

## THE TRADITIONAL BALING MACHINE



*Operating a baling machine at the Spring Run Farm. Dresber, Pennsylvania, 1944  
Photo: Pauline Ehrlich, US Library of Congress*



*Baling machine operating at the Spring Run Farm. Dresber, Pennsylvania, 1944  
Photo: Pauline Ehrlich, US Library of Congress*



*A bale being dropped from baling machine. Dresber, Pennsylvania, 1944  
Photo: Pauline Ehrlich, US Library of Congress*



*Making adjustments to a baling machine. Dresber, Pennsylvania, 1944  
Photo: Pauline Ehrlich, US Library of Congress*



*Detail of a baler showing rotating knives which cut hay into proper lengths. Photo: Pauline Ehrlich, US Library of Congress*



*Detail of bailing machine. The propylene twine which binds the bales is inserted in spools. Photo: Pauline Ehrlich, US Library of Congress*

## NEBRASKA STYLE

Bales are load-bearing, supporting themselves and the roof load. Wind uplift is resisted by cables or threaded rods that are anchored in the concrete footing. Plaster is a structural component used to stiffen the wall and transfer lateral loads to the foundation. The Pima County Code limits the height-to-thickness ratio to 1:5.6 (equalling a 10'-8" height for a 23" wide wall, the approximate width of a bale laid flat). The length-to-thickness ratio in plan view is limited to 1:13 ( 25' length for a 23" wide wall). Advantages of this system include the efficiency of combining structure with enclosure and reduction in use of lumber, and the lowest possible construction cost. This system lends itself well to self-help housing. A disadvantage is the dimensional restriction in height and plan configuration, in contrast with the Infill/Post & Beam style illustrated on the facing page.

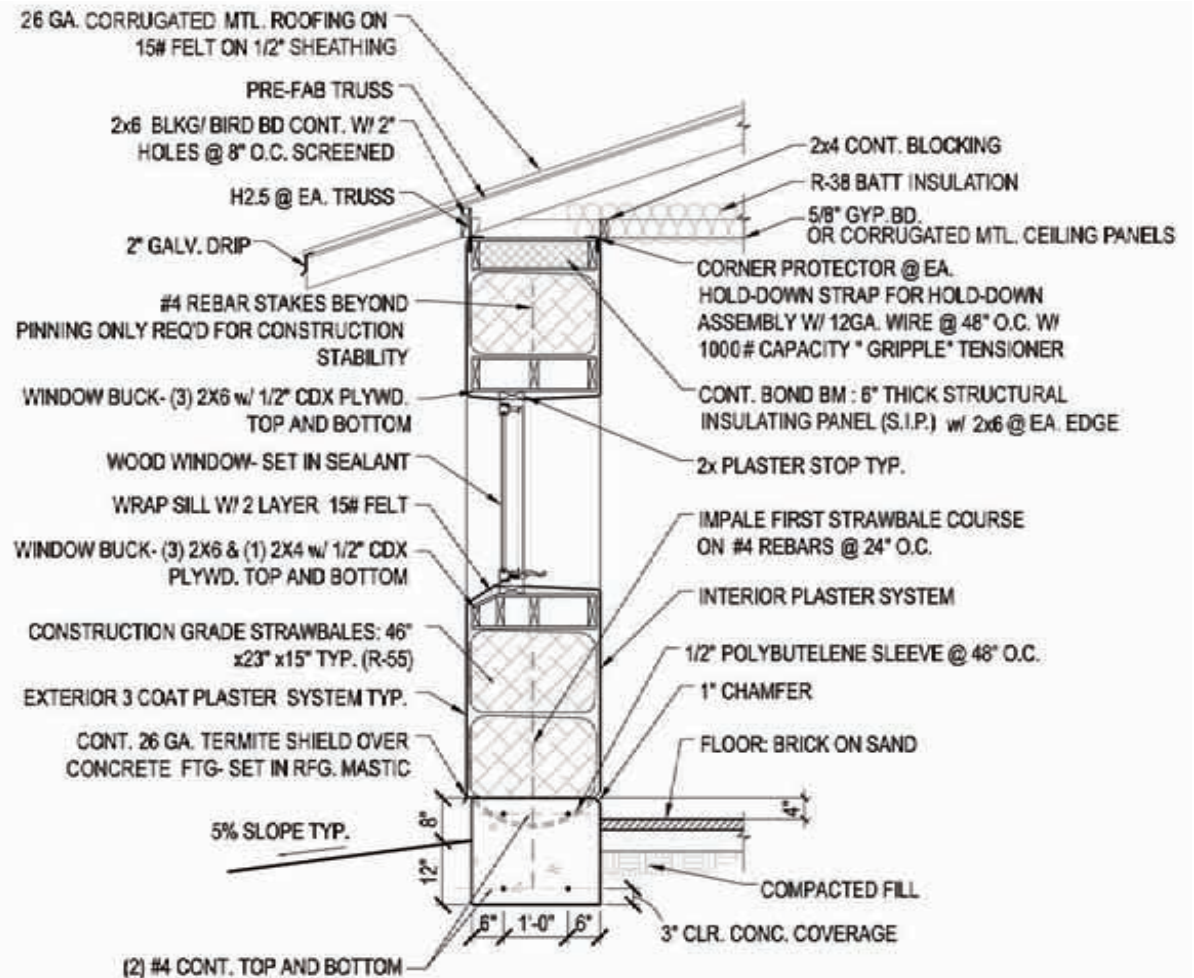

## NEBRASKA STYLE (LOAD BEARING) WALL SECTION

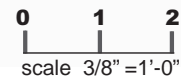

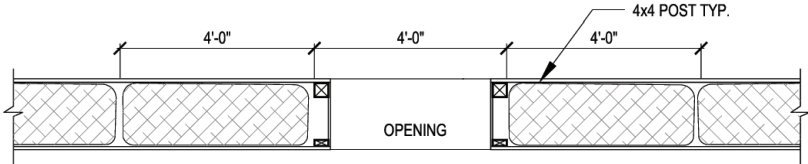

PLAN DETAIL

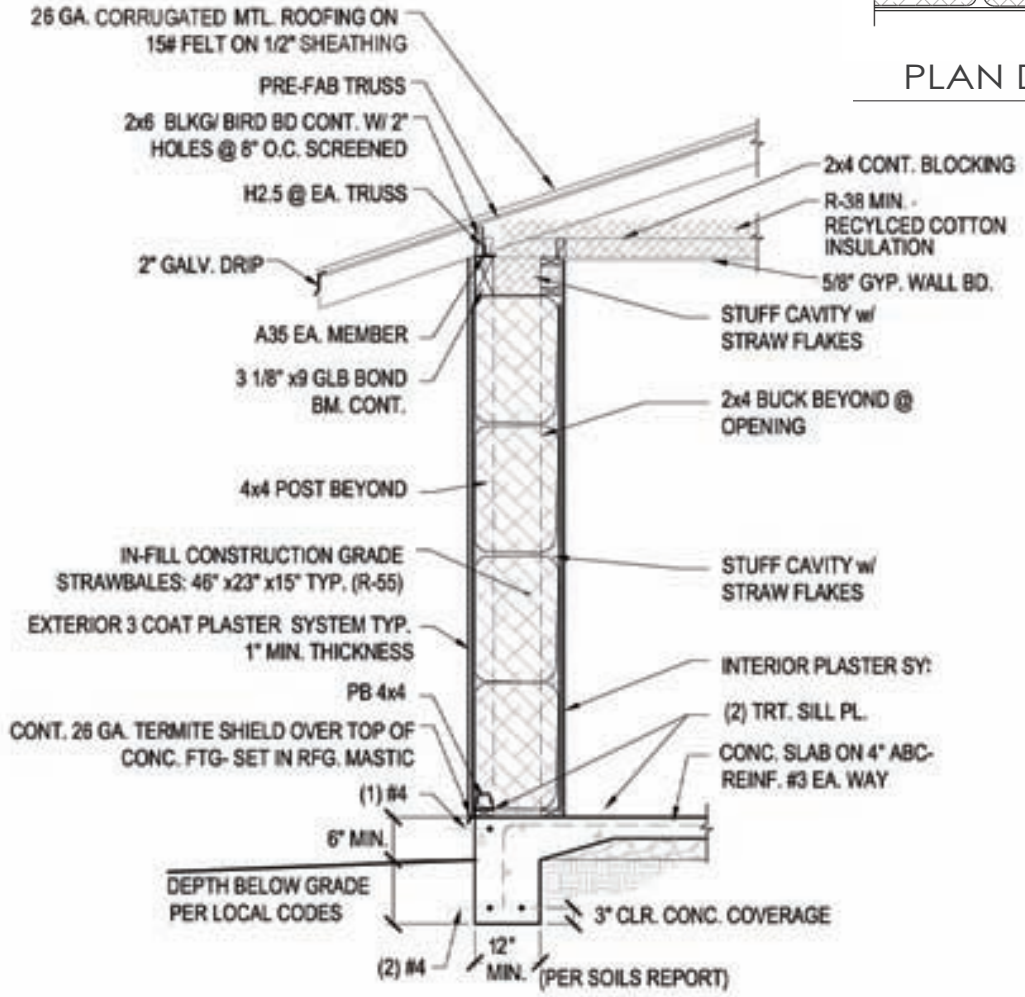
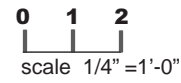

INFILL (POST AND BEAM) STRAWBALE WALL SECTION

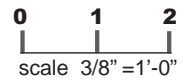

INFILL STYLE

With the infill “Post and Beam” style, an independent structural system carries the loads from roof to foundation, and straw bales are used as infill to create the enclosure. Milled lumber is the most frequent material for supporting elements, although concrete block piers and concrete or steel columns have been used. The advantage of this system is greater design flexibility, including the possibility of designing for more than one story in height. This system has greater long-term stability and can be custom-engineered, in contrast with the prescriptive approach used in the Nebraska style. It is a more sophisticated system requiring skilled labor, and is, therefore, more costly.

## REGIONAL APPROPRIATENESS

While baled straw is not a traditional building material of the U.S. Southwest, straw bale houses have been proven to adapt well to the desert climate. Many lessons learned from traditional desert housing have been incorporated into straw bale design. The native material palette of earth, sand, lime, and small diameter timber (saguaro ribs, ocotillo stalks and mesquite branches) integrates well with straw bale construction techniques.

The use of straw has precedents in regional building traditions. Straw was commonly mixed with mud for adobe blocks and earth plasters. Loose straw left over from erecting bales can be used in mud plasters and earth floors, lending tensile strength to the earth.

The relative softness and elasticity of earth plaster is more structurally compatible with straw than cement plaster in terms of thermal expansion and contraction. This relationship is important given the great diurnal and seasonal temperature swings of the desert.

Straw bale walls must be protected from moisture, insects and fire, by plastering both the interior and exterior surfaces. The plaster coating is one inch or greater in thickness, varying with the irregular surface of the bales. Stucco netting is often wired to the bales to provide greater adherence and reinforcement to the plaster. As with adobe, the plaster skin of a straw bale wall must “breathe” (i.e. permit the transpiration of water vapor) to prevent the accumulation of moisture within the wall.



*Tucson, AZ: Volunteers place straw bales around a window buck. This one-bedroom house has a modest 676 sf net floor area, but has been enjoyed by the owner since 1997. Design: B. Vint, Architect Photo: B. Vint*



*Tucson, AZ: The finished house has an east-facing porch, a sheltered transition from the interior to the desert environment. Earth plaster stabilized with lime and mesquite porch posts from the site demonstrate the integration of regional materials. Deep overhanging eaves provide shade and protect walls from rainfall. Photo: B. Vint*



Plaster finishes also serve to stiffen straw bale walls, and to transfer lateral and gravity loads from the roof diaphragm to the foundation. The interior and exterior layers of plaster, when well-tied through the straw, create a sandwich panel analogous to corrugated cardboard.

While current building codes recognize cement plaster as the most structurally reliable finish for straw bale walls, earth or lime-based plasters are in fact superior for their greater breathability and material compatibility. Standards must be developed, and building codes must be revised to include earth and lime plasters.

Simple traditional building forms which evolved from the masonry tradition of the Southwest can be readily adapted to straw bale construction. Many straw bale houses being built today (especially of the Nebraska style with load-bearing walls) feature simple plans of less than 1,200 net square feet in floor area, with gabled roofs for shedding water quickly .

Attached porches are a traditional design element that provide shaded outdoor space and additional protection for the straw bale walls from both the sun and rain. Porches are inexpensive to build and can augment the compact living area of an affordable house.

A great advantage of straw bale construction is that it is highly insulating. Research by the California Energy Commission in 1998 found that a typical 3-string bale laid flat in a Nebraska style load-bearing wall has a thermal resistance factor or R-value (the measure of a material's ability to prevent heat transfer) of

33.5. The same type of bale laid on edge in a post and beam structure achieves an R-33. The R-value of a 2-string bale laid flat is approximately R-29, while on edge it is R-26. This compares favorably with a conventional 2x6 wood frame wall, which has an insulating factor of R-19.

In construction, gaps between bales must be packed with loose straw (called "flakes" in the bale builder's terminology) before plaster is applied, to prevent air infiltration which would reduce the wall's insulating efficiency.

To maintain a continuous building envelope roofs must also be well-insulated. High insulation conserves energy and reduces utility bills for the home owner. Many types of insulation are available, including fiberglass, recycled cotton fiber batting and cellulose made from recycled newspaper. Straw bales themselves may be used to fill spaces between roof trusses. While a deeper discussion of these materials is outside the scope of this study, a minimum roof insulation of R-38 is recommended.

A highly insulated exterior combined with high thermal mass interior materials (such as earth walls, floors, or benches) creates ideal conditions for a "passive-solar home." South-facing windows with properly sized overhangs allow direct solar energy to enter the house, where the heat is stored in the thermal mass to warm the house overnight. Owners of straw bale homes report interior temperatures in the 70s° F year-round with minimal mechanical heating and cooling.

Since the early 1990s, several non-profit groups including the Proyección Humana de

Mexico, the Kutunza Institute, the Canelo Project, and Builders Without Borders, have worked to teach self-help straw bale construction to needy families in the Southwest. Straw bale is an affordable and advantageous alternative to shipping pallets and tar paper used to build houses in the border colonias and on Native American reservations.

Katia LeMone of the Kutunza Institute reports an interesting adaptation of straw bale in Mexico, where straw has been used in place of the usual concrete block infill in concrete post and beam structures which are typical of Mexico. Straw insulation greatly reduces heat loss and gain, keeping the houses much more comfortable for the low-income families who dwell in them.



*Guadalupe, AZ: 1,100 sf three bedroom, load bearing straw bale home financed by HUD for a low-income family in 1997. 160 volunteers raised the bale walls and framed and sheathed the roof in a single day. The interior and exterior stucco was done later. This project was a joint effort of HUD, The Development Center for Appropriate Technology (DCAT) and Out-On-Bale (un)Ltd. Photos courtesy of M. Myhrman & J. Knox*

## AFFORDABILITY

### RESOURCE RECYCLING

Of the three alternative materials considered here, straw bale is the least expensive in terms of first cost. The overall construction cost for a straw bale home is comparable to that of a conventional wood framed house. Straw is a plentiful by-product of industrial agriculture, a viable building material that otherwise becomes compost or is burned. Straw bale is an especially economical choice for rural housing, since the raw material is readily at hand and shipping costs are low. Yet savings can be realized in both rural and urban housing. Because the supply is high, bales are inexpensive. It is estimated that the amount of timber in a conventional home may be decreased by 50 percent through the use of straw bale. Reduced use of lumber saves logging and trucking costs, and preserves the nation's forests. A well-built and maintained straw bale house can last for generations, as evidenced by the first generation of straw bale buildings in Nebraska which are now a century old. When a building has lived its useful life and is finally torn down, the wall material can return to the earth as straw is biodegradable.



*When straw is in excess some farmers resort to burning it. Increased demand for baled straw will not only reuse the resource but prevent carbon dioxide emissions.  
Photo: University of Arkansas Division of Agriculture*

## EFFICIENCY

### SPACE AND ENERGY

The high R-value of straw bales and the use of compact, simple house designs increases the energy efficiency of housing. This translates into significant reductions in utility costs over the life of the dwelling. As analyzed by David A. Bainbridge in the "Life Cycle Cost and Value of Four Homes" in *The Art of Natural Building*, a 100 year life cycle cost for an owner-built passive solar straw bale home is estimated to be 37 percent of the cost of owning, maintaining and operating a conventional house (\$347,700 vs. \$947,900). Compared with a conventional house, a contractor-built straw bale home is predicted to have a cost savings of 11 percent over the same 100 year period (\$843,300 vs. \$947,900).

The environmental impact of the energy savings of straw bale construction is dramatic. A passive solar straw bale home is estimated to reduce carbon dioxide emissions by nearly 85 percent in comparison with a conventional wood frame house (CO<sub>2</sub> emissions reduced from 9.3 tons/year to 1.4 tons/year according to the study cited above).



*In the Colonia Anapra straw bale house, bales are used as roof insulation between palette trusses.  
Photo: C. Wanek*

## SELF - HELP

### CONSTRUCTION

Straw bale construction can be done using unskilled labor in several phases. Pouring concrete footings, placing bales to raise the walls, applying interior and exterior plaster and installing earth floors are examples of tasks that can readily be done by volunteers or owner/builders. Framing roofs and installing jambs (or "bucks") around windows and doors requires greater skill, and is often done by professional carpenters working in conjunction with a crew of volunteers. Licensed electricians, plumbers, and heating, ventilating and air conditioning technicians are brought in to perform their trades. In particular with the Nebraska style of load-bearing straw bale construction, family members including children are able to participate in the construction of their own home. In owner-built or sweat equity housing, opportunities for personal and family expression can be found. The use of clay paints, sculpted plaster and carved niches are part of the folk-art tradition of the border region. Following are two case studies of successful affordable straw bale houses built with direct owner participation.



*Volunteers from the earthen plastering work day leave an impression at the entrance of Carolyn Robert's home.  
Photo: C. Robert*

## COLONIA ANAPRA STRAW BALE HOUSING

### designer/builder

*Builders Without Borders (www.builderswithoutborders.org)*  
*World Hands Project (www.worldhandsproject.org)*  
*Casa de la Cruz in conjunction with local labor trainees*

### location

*Colonia Anapra (pop. ca. 20,000 in 2001)*  
*Ciudad Juarez, Chihuahua, Mexico*

### clients *families of Anapra Colonia*

Since the mid 1960s, US/Mexico border cities have experienced rapid population growth, far outstripping the housing supply. Many families live in poverty without proper shelter or sanitation. There are over 200 *colonias* (informal settlements) in and around Ciudad Juarez, the Mexican city of 3,000,000 inhabitants just across the international border from El Paso, Texas. Discarded shipping pallets and tar paper are the common building materials for *jacales* (huts) inadequate to shelter their inhabitants from climatic extremes.

Among the private non-profits working to improve health and living conditions in Ciudad Juarez is Builders Without Borders. This humanitarian group has organized direct assistance for families of the Colonia Anapra in Juarez. In cooperation with The World Hands Project and Casa de la Cruz, BWB has organized affordable housing projects that are “culturally appropriate, economically profitable, and environmentally sound” (*builderswithoutborders.org*). These groups demonstrate that straw bale housing is a viable answer to the housing needs of Colonia Anapra and beyond.



*View of Colonia Anapra, Ciudad Juarez, Chihuahua.*  
*Photo courtesy of The World Hands Project*



*Volunteers carry pallet trusses to be set atop the completed bale walls. The trusses rest on a continuous wood bond beam which ties all the walls together. Photo: C. Waneke*



*The straw bale house of José Luis before exterior plastering. Photo: C. Waneke*

*“BWB has assisted in the building of four homes for local families. The houses are intended to demonstrate to the residents how to build comfortable, well-insulated, low-cost homes out of natural and recycled materials. They are designed to make use of passive solar heating and utilize shipping pallets to fabricate roof trusses. The straw bale walls rise from simple foundations, the walls are finished with earthen plasters.”*

**Builders Without Borders**  
February 2004 Newsletter



*Applying earth plaster to the interior of a straw bale house in Colonia Anapra. Photo: C. Waneke*



*"Adriana and her children in front of their old house."  
March 2002, Colonia Anapra  
Photo courtesy of The World Hands Project/BWB*



*"The group (family and volunteers) in front of Adriana's finished house." March 2002, Colonia Anapra  
Photo courtesy of The World Hands Project/BWB*



*Volunteers build pallet trusses. Wooden pallets are plentiful in Mexican border towns as a result of the maquiladora factories. Re-using pallets not only saves the homeowner material costs, but is environmentally advantageous both for forest preservation and a reduction of carbon dioxide emissions due to reduced trucking of materials. Photo: C. Wanek*

By organizing straw bale housing workshops in Colonia Anapra, BWB trains home-owners and local workers in building with straw, earth, and available natural resources. The workshops include all stages of straw bale construction beginning with site preparation, bale raising, window/door buck framing, bond beam and pallet truss installation, wall pinning and strapping, straw ceiling insulation, roof assembly, electrical wiring and earthen plastering.

Stages of a complete project are outlined here:

1. Develop home designs and gather owner input and feedback.
2. Require direct participation of owners who will have a specified number of hours on construction required through a family and friend network.
3. All homes will feature thermally efficient envelopes, passive solar design using natural building materials and methods.
4. Simple electrical and plumbing systems, including a biological waste system utilizing waste water for landscaping and food production, if applicable.
5. The option for owners to finance amenities such as solar hot water heaters, solar stills, solar ovens and cisterns.
6. Insulated metal roofs assuring longevity of the building and a thermal break from the extreme heat and cold.
7. Simple rainwater catchment systems

Funding for the housing is organized so that repayment of "micro-loans" is re-invested in the local community. The houses take a month to complete at an average cost of \$6,500 for materials and labor, due to the donation of labor and the resourcefulness of participants.

## CAROLYN ROBERTS STRAW BALE HOUSE

### owner/builder

Carolyn Roberts

Jon Ruez, *Straw Building Consultant*

### location

Avra Valley west of Tucson, Arizona

residence area 1,200 sf (gross)

995 sf (net)

final cost \$51,450. (2002)

This straw bale house was designed and built using the owner/builder method. Because she was involved in the process from beginning to end, the owner saved a considerable amount of money. Her personal documentary of the process of building her straw bale house, entitled *A House of Straw: A Natural Building Odyssey*, was published in 2002. The next few pages show the progression of her Nebraska style straw bale project, from laying out the foundation to earth plastering the interior and exterior walls.



Plan of the Roberts house, planned for maximum use of limited space. The southern "Sun Room" acts as a passive solar collector. Illustration: Wayne Bingham

### final cost per square foot (2002)

"Without the porch expenses, using exterior dimensions for 1200 sq ft, cost was \$37.00/sq ft."

"Without the porch expenses, using interior living space of 995 sq ft., cost was \$45.00/ sq ft."

"Porch costs were \$7,000.00 for 925 sq ft of covered porch, or \$7.50/sq ft. "

Expense information from [www.houseofstraw.com](http://www.houseofstraw.com)

### BREAKDOWN OF COSTS CAROLYN ROBERTS STRAW BALE HOUSE

ITEM	ACTUAL COST	HRS. OF LABOR	% HIRED LABOR
PLANS	\$1,050	MANY	100
TOOLS	\$1,900	--	--
CONSULT.	\$5,000	--	--
PERMIT	\$3,500	--	--
SEPTIC	\$1,500	NONE	100
FOUND.+			
STEM	\$5,500	235	25
FLOORS	\$ 600	131	0
BALES+			
WALLS+			
PLASTER	\$4,800	970	110
TRUSSES+			
ROOF	\$5,200	188	25
PLUMB.+			
FIXTURES	\$3,000	107	0
ELECTRIC+			
APPLI.	\$4,500	133	20
MISC.	\$2,000	--	--
WINDOW+			
DOOR	\$3,000	97	25
LOFT+			
STAIRWAY	\$3,000	110	50
PORCH	\$7,000	155	85
CABINET	\$ 300	15	0
<b>TOTAL</b>	<b>\$51,450</b>	<b>2,041</b>	<b>--</b>

"My greatest savings would come from doing the majority of the labor myself, so I kept it simple. In the passive solar design, I considered my desert environment and the angles of the sun to keep the house cool. In the construction, I used nature's gifts of straw, sand and clay wherever possible, because they are beautiful, inexpensive and harvested with minimal damage to the earth."

Carolyn Roberts



The owner atop prefabricated 2x4 wood trusses which form the gable roof structure. Photo: A. Proczka

## APPLICATIONS



*“The truck is called a ‘bale squeeze.’ It has a big gripper on the back that tips up like a dump truck and stands the entire truckload of bales in a big stack. Then we slid them down some plywood planks to reach the ground. They were able to stay intact and undamaged this way.”*

*Quote & photo: C. Roberts*

laid flat  
for use with  
Nebraska style  
load-bearing walls.

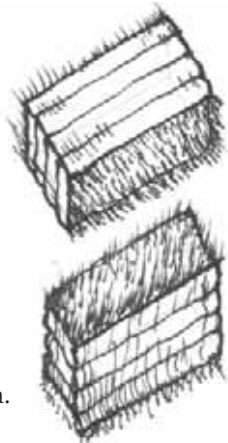

on edge  
for use with  
post & beam  
infill construction.

All dimensions of a straw bale house depend on the length, width, and height of the bales to be used. Straw bale houses must be designed using the module of the bales as a planning unit, with allowances for window and door bucks and/or support posts (if the post and beam system is used). Designers should verify locally available sizes, as there are variations resulting from the baler used in harvesting. A common nominal size is 48” in length, 24” in width and 16” in height.

## WALL SYSTEMS

The wall sections at the beginning of this chapter illustrate the two basic straw bale wall types: 1. Nebraska style (load bearing wall) and 2. Post & Beam style (infill wall). These two methods of employing straw bales in construction are described in the Pima County (Arizona) Straw Bale Building Code, Section 7203:

1. *Laid Flat* refers to stacking bales so that the sides with the largest cross sectional area are vertical, and the longest dimension is parallel with the wall plane.
2. *Laid On-Edge* refers to stacking bales so that the sides with the largest cross-sectional area are vertical, and the longest dimension is parallel with the wall plane.

Bales laid flat rest on their largest surface and can accept more load than bales laid on-edge. When bales are laid flat the straw fibers are oriented horizontally, and the ties are subjected to less tension than the ties of bales placed vertically. The “Bou-Ali tests” (from a Master’s thesis at the University of Arizona College of Architecture) found the compressive strength of 3-string bales laid flat to be three times greater than that of bales laid on-edge. This study also found that plaster bonds better to bales laid flat, since the rough edges provide a good “key” for plaster to interlock with.

“Construction grade” bales should have a moisture content less than 20 percent by weight at time of installation, and should be allowed to dry further before plastering. The minimum dry density should be equal to or greater than 7.0 lbs. per cubic foot per Pima County Code.

## FOUNDATIONS

Conventional foundation systems are suitable to support straw bale walls. Concrete grade beams or slabs-on-grade with a continuous slab-edge toe-down are the most economical choices for dry climates and where no basement is desired. A steel-reinforced spread footing with a concrete or cement block stem wall may be used to support a wood floor system. The bales must be elevated a minimum of 8” above exterior finish grade and no less than 1 1/2” above the interior floor level with a pressure treated plate. Damp-proofing of the top of the foundation and a sheet metal termite shield will also help prevent water from wicking into the straw bale walls. A final structural requirement is that both interior and exterior plaster layers should bear on the foundation to transfer lateral forces into the foundation.

## ROOFS

Preventing moisture penetration is the most important factor in a straw bale building. Corrugated pre-finished metal panels are the most reliable roofing material. Gabled or hipped roof forms, with a 4:12 or greater pitch to quickly shed water, are preferred. In dry climates, shed roofs should have a slope of no less than 2:12. Local codes should be consulted to confirm minimum slopes. Roof overhangs are recommended to be at least two to three feet beyond the face of the wall. Proper flashing of roof/wall intersections is imperative. Deep porches keep rain away from exterior walls. Roofs should be insulated to R-38, consistent with the R-value of the bale walls..



**1** Foundation staked and laid out w/ spraypaint.



**2** Concrete footing poured and block stem wall built.



**3** Window and door bucks built and set in place.



**4** Volunteers erect bale walls on workday.



**5** Bond beam evenly puts 4 bale walls in compression



**6** Roof trusses mounted to bond beam



**7** metal roofing added and porches framed



**8** electrical conduit integrated with bales



**9** clay slip pressure applied before earth plastering

## THE BUILDING PROCESS

*All photos on this page courtesy of C. Roberts.*



*View of completed home from west. Photo: C. Roberts*



*View of completed home from south showing sun space at entry with aviary. Photo: C. Roberts*



*Interior view showing living area and loft. Photo: R. Peterson*



*View from west. Photo: J. Ruez*





## stone and concrete **FOUNDATION SYSTEMS**

---

Traditional houses built in the U.S. Southwest during the 19<sup>th</sup> and early 20<sup>th</sup> centuries, prior to the common use of concrete, typically had foundations built of stone, if they had foundations at all, which some did not. The use of stone for foundations dates back 300 years to the early mission churches of northern Mexico that were built of adobe on dry stacked (mortarless) stone foundations. The mission church of San Xavier near Tucson (ca. 1783) has a volcanic stone foundation laid in lime mortar supporting its massive walls of fired brick. Stone is much harder than brick, and in human terms is impervious to water. It is, therefore, a logical choice as a foundation material, to bear the weight of the structure above, transfer it into the ground, and resist the weathering that takes place where buildings meet the earth.

## structure and covering **ROOF SYSTEMS**

---

The roof system of an adobe, rammed earth or straw bale house is of equal importance to the foundation in maintaining structural integrity and protecting the walls from moisture. Traditional materials must be kept dry, or failure of the wall system results. Furthermore the roof diaphragm serves to brace the walls against lateral forces resulting from wind or earthquakes.

## STONE FOUNDATIONS

Vernacular builders used whatever materials were available, and naturally employed local stone for foundations. Limestone, granite, and volcanic basalt are found along the U.S./ Mexico border. Igneous and metamorphic stones, being extremely hard, were used as they were found, as rubble or fieldstone. Relatively softer limestone was typically dressed or squared into building blocks.

Foundations were laid in trenches excavated to a level of hard bearing soil, varying in practice from 12 inches to 36 inches in depth. Prior to the widespread availability of Portland cement in the early 20th century, stone was set in locally produced lime and sand mortar. Rubble stone is irregular in shape and size, hence mortar joints are wide, with smaller stones used to chink spaces between larger ones. Dressed stone is cut to regular sizes and requires thin mortar joints.

Stone foundations are a traditional vernacular response to building in pre-industrial times. However they cannot easily be reinforced with steel to resist bending caused by differential settlement, and they are labor intensive and, therefore, costly in today's marketplace. For both structural and practical reasons, reinforced concrete and concrete block have replaced the traditional stone foundation.

Among Southwestern vernacular dwellings, stone foundations were often left exposed for protection against water or for aesthetic reasons. The rich texture and color of stone add visual interest to a simple facade. In bungalows, stone was often exposed along the base of the structure for a rustic appearance in keeping with the romantic quality of the style.

The conditions under which stone foundations are feasible today are (1) a ready supply of stone is available on site, and (2) local masons are willing to donate or discount their labor in the installation. Such a process was followed for the Elder's Center of the Tohono O'odham Nation, in which the entire building was constructed of volcanic stone from a nearby sacred mountain. This is a unique project, and not readily reproducible.



*Dressed stone foundation at La Casa Cordova Tucson, AZ. Height of stone above grade protects adobe from splashing of rainwater and isolates wall from rising foundation moisture. Photo: B. Vint*



*Volcanic basalt used for site retaining wall and foundation early 20th C. bungalow, West University, Tucson AZ Photo: B. Vint*



*Elder's Center, San Xavier District. Foundation and walls built of volcanic stone. Gibbs & Vint, Architects Photo: B. Vint*

## CONCRETE FOUNDATIONS

Concrete foundations are suitable for any of the three wall systems addressed in this study. Because adobe and rammed earth are both heavy and brittle materials, the slightest settlement of the foundation causes cracking. Earthen walls require a well-designed footing specifically engineered for site soil conditions and actual live and dead loads. A geotechnical investigation of the building site is recommended to determine the allowable soil bearing pressure, and to check for the presence of collapsible soils or expansive clays that may require additional site work, such as over-excavation, re-compaction, and/or greater footing width, depth or reinforcement.

There are several types of foundations used for residential construction, with advantages and disadvantages for varying materials and site conditions. For adobe walls, a concrete foundation system consists of a footing to distribute the wall load evenly into the earth, and a stem wall to bring the bearing level of the wall above grade. Steel reinforcing bars are placed in both footings and stem walls to provide tensile strength such that the foundation can span over areas of settlement, or should the soil become saturated.

In all cases, the builder must provide a minimum six inch separation between the adjacent finished grade and the earthen or straw bale wall to be supported, to protect the wall base from moisture.



*Cast in place foundation for a straw bale house in Tucson, Arizona. Continuous concrete perimeter ties bale walls together and elevates them above ground level to keep them dry. Vertical rebar dowels are used to pin first course of bales to foundation to prevent them from sliding under lateral loads. Floors will be brick laid over sand. Architect: Bob Vint, Tucson. Photo: B. Vint*



*Foundation stem wall for an adobe house in Tucson, Arizona. The stem wall is solid grouted CMU with horizontal and vertical reinforcing. It is supported on a reinforced concrete footing approximately 12 inches thick, placed at two feet below grade. The footing and stem wall together constitute the foundation system. Floors are to be colored concrete slabs on grade. Architect: Bob Vint, Tucson. Photo: B. Vint*

## WATERPROOFING FOUNDATIONS

---

Unlike other regions of the US, subterranean water is not a common problem in the Southwest. Stemwalls typically do not require damp-proofing. Nonetheless, it is required to waterproof the top of foundations for either straw bale or earthen wall system to prevent moisture from wicking up in the walls following the brief, heavy rainstorms of the desert.

## SPREAD FOOTING AND STEM WALL

---

The most common foundation system for masonry walls (including adobe and rammed earth) is a continuous cast-in-place reinforced concrete spread footing, with either a concrete or a solid-grouted concrete masonry unit (CMU) stem wall. For rammed earth construction, where masons are not typically on the job site, a concrete stem wall is more common than CMU. This type of foundation is illustrated in the adobe wall section at *p.82* of this study.

### CONCRETE GRADE BEAM

---

If there is adequate soil bearing capacity, the required footing width often matches the wall width for earthen materials (adobe or rammed earth). In this case the stem wall and footing are placed with a single pour, reinforced top and bottom with steel bars. It is termed a grade beam foundation, for it acts as a concrete beam cast in the earth. This system may also be used for straw bale walls, if deemed appropriate. A grade beam type of foundation is illustrated in the rammed earth wall section at *p.90*.

## FLOOR SLABS

---

Concrete slabs-on-grade are typically 4 inches thick. To limit cracking, slabs can be reinforced with welded wire fabric (WWF) or with #3 steel reinforcing bars at 24 inches on center each way. Rebar are placed 1-1/2" inches below the top of the slab. Tooled or saw-cut joints can also be used to control cracking that results from expansion and contraction. This approach plans where the crack will occur, rather than trying to prevent it. Workmen must properly score the joints deep enough to establish a weakened plane in the concrete slab, so that the crack occurs where intended. A cast-in-place concrete slab with integral color powder added the mix creates a durable, economical and aesthetically pleasing floor is.

Concrete colors are mineral based and permanent. The concrete can be sealed and polished, and provides a large thermal mass for use in passive heating and cooling. Exposed concrete floors should have a well-thought out pattern of score joints to control cracking.

## POST-TENSIONED SLAB FOUNDATION

---

Post-tensioned slabs on grade have been increasing in popularity in the Southwest since 1995. They have advantages where soil conditions are poor, and can minimize slab cracking. They are not as prevalent with heavily edge-loaded wall systems, such as adobe or rammed earth, because of potentially increased edge deflections due to the heavy wall loads.

## SLAB EDGE TOE-DOWN

---

Wood frame walls in conventional construction are typically supported by a thickened slab-edge footing, or toe-down, which runs around the perimeter of the house. Horizontal rebar are placed longitudinally in the toe-down to provide bending strength. Anchor bolts are spaced as needed to anchor the walls resisting lateral forces (wind or earthquake).

Straw bale is more closely related to wood frame construction than to masonry. A slab edge toe-down foundation may be used to support straw bale walls. The bales are pinned to the slab with rebar extending from the footing. A toe-down footing is illustrated at the straw bale wall section at *p.99*.

## ROOF STRUCTURE

### HEAVY TIMBER

Traditional adobe houses were roofed with timber beams hewn from local trees. Along the U.S./Mexico border, this includes mesquite, pine and cottonwood. The size of beams was derived from the nature of available trees. Mesquite is a dense, hard wood, excellent for use as lintels in adobe walls: however, mesquites do not grow more than twenty to thirty feet in height, and their twisted branch structure does not produce long straight timbers for roof framing.

Pine trees are more suitable for use as roof beams, growing straight and tall: yet they grow only in the surrounding mountains, and in the historic period the greater effort required in bringing them to the building site posed a great disincentive to their use. Cottonwood is a faster-growing wood less suited to structural



*Installation of prefab wood trusses in new adobe house. Porch is framed with recycled timbers. Sloped trusses composed of 2x4's are an economical means of creating a pitched roof with attic space. Design: Bob Vint, Architect.*

*Photo: B. Vint*

use. Despite its limitations, mesquite was the most frequently used timber in the Arizona/Sonora border region. A typical maximum span is 14 feet, limiting the size of rooms.

Beams varied in size, from 6 to 8 inches in width and from 10 to 12 inches in depth. The spacing of beams was from 18 to 30 inches on center, made necessary by the weight of the earthen roof carried on cactus rib or cane lathing (*latillas*). The vernacular desert adobe house was a model of organic environmental architecture, built of natural, recyclable materials.

Nonetheless, the roof framing system is not reproducible in contemporary society for several reasons: (1) use of large timbers is prohibitively expensive due to labor, material and transportation costs; (2) heavy timber is environmentally destructive, as old-growth trees have become scarce due to long-term unsustainable logging practices; (3) the use of saguaro cactus ribs for ceilings is impossible, as the large-scale demand for ribs would deplete the desert of saguaros, quite apart from the fact that the saguaro is now a protected plant; and, (4) traditional earthen roofs are excessively heavy, prone to damage in earthquakes, have little insulation value, and leak. Although the traditional method of framing roofs is aesthetically appealing, it is not practical for contemporary affordable housing.

### MILLED LUMBER AND PREFABRICATED TRUSSES

An alternative to heavy timber is milled dimension lumber, which supplanted timber in the late 19th century. The ubiquitous two-by-four was used to frame roofs throughout the west from 1880 on. A contemporary adaptation of light two-by framing is the prefabricated wood truss, a method of factory-building longer span elements. This is a relevant method for framing today's affordable housing, as it is among the most economical systems now in use. Its limitations are the vulnerability of wood to fire, moisture and termites.

With the growing public consciousness regarding green building, the Forest Stewardship Council (FSC) has been formed to encourage sustainable timber practices. Developers, architects and builders can now specify FSC Certified lumber, which indicates that sustainable practices are employed in growing harvesting the timber.

Wood is a renewable resource if it is well-managed, even more so if timber for construction is grown on tree farms rather than harvested from our national forests.

In contrast with finite mineral resources, such as iron, coal or oil, which must be mined and refined, wood is organic and naturally regenerates itself. One can always plant a new tree.

## ROOF STRUCTURE

### LIGHT GAUGE STEEL TRUSSES

Currently, light gauge cold-rolled steel trusses are becoming an alternative to wood trusses in the affordable housing market. They have many advantages in comparison with wood trusses. Steel trusses are more dimensionally stable than wood as they are not prone to pests, rotting, warping or swelling with changes in humidity. In addition, they are noncombustible and, if galvanized, impervious to water. Their cost is variable as the price of steel varies with market conditions.

However, metal trusses and metal roof structural systems have not been as well accepted in conventional practice as metal framing for walls. All connections must be screwed, hence they cannot be easily assembled with nail guns and circular saws. Sheet metal reacts differently than wood when cut, and the sharp edges of metal angles and channels pose an occupational hazard. Nonetheless, this is a valid system to consider, provided there is a local truss plant that fabricates with light gauge steel. Local manufacturers are emerging throughout the U.S. Southwest.

Municipal building safety departments typically require detailed shop drawings and structural calculations sealed by a registered engineer for both steel and wood truss systems. These are generally provided by the truss manufacturer.



*Light gauge steel truss framed roof with metal framing at gable end. Affordable row house under construction in Tucson, AZ. Architect: Joe Comella, City of Tucson Community Services Department. Photo: B. Vint*



*Tucson, AZ: Asphalt roll roofing on the hipped roof of a historic building. Roll roofing is the least expensive and least durable roofing option. Photo: B. Vint*

## ROOF COVERING

### ASPHALT AND ELASTOMERIC

Nationally, the most common roof coverings are asphalt based. These are among the least expensive roofing systems when considering initial installation costs.

Asphalt-impregnated felt paper has long been used in waterproofing low-slope roofs, pitched at 2:12 or less. Built-up roof systems comprise three to four layers of roofing felts laid with asphalt emulsion.

For sloped roofs pitched at 3:12 or greater and exposed to view, asphalt roll-roofing with a mineral cap surface was a common material over the first half of the 20th Century. Asphalt-based fiberglass shingles have been widely used on sloped roofs for the past 50 years.

The limitation of asphalt roofing in the Southwest border region is the drying effect of the intense desert sun, which causes the felt layers to crack and separate. In recent years, elastomeric roof coatings have been developed to protect and renew asphalt roofs. It is recommended to re-coat asphalt roofs every two years to extend the expected ten-year life time of the roof.

A disadvantage of asphalt roofing is that when rainwater harvesting is desired, emulsion will find its way into the runoff.

Single-ply membrane and elastomeric roof coverings, either in sheets or fluid-applied, are contemporary systems with higher first-costs, but greater durability relative to asphalt-based systems.

## ROOF COVERING

### METAL

Corrugated galvanized iron (CGI), has been available for over a century in the U.S. Southwest. Its use became widespread in the late 19th century, in western mining camps and other provisional settings. CGI roofing was used on ranches and in the historic barrios, for then as now it proved to be an economical and effective waterproofing choice.

CGI is available in a range of gauges and configurations. A mid-range specification is 26 gage, 3/4" C-panel, being among the most common. Heavier gauges last longer, but are more expensive. A properly secured CGI roof, with the correct felt or membrane underlayment and sheathing, can last for over 20 years. It is also suitable for the harvesting of rainwater, as the metal surface can be cleaned and does not release petrochemical residue as does asphalt roofing

Corrugated metal roofing is a logical and responsible choice for affordable housing, and its use is an extension of the vernacular tradition.

However, while CGI is relatively inexpensive, effective and durable, it also has three disadvantages: (1) metal is an excellent conductor of heat, hence additional insulation is advisable; (2) factory galvanized metal is reflective and creates glare, hence some treatment to dull the surface or finish it is needed; and, (3) rain falling on a metal roof is noisy.

Another type of metal roofing is known as standing seam. This is fabricated from sheet metal panels in widths from 12 inches to 20 inches, which are joined at the seams and crimped to lock them together. A standing seam roof is typically pre-finished with a factory applied paint and is good for 50 years. This is a more advanced, and more expensive roofing system than CGI. It is generally not considered feasible for affordable housing.



*New Mexican ranch house with corrugated galvanized iron roofing. This metal roof is approximately 50 years old, and is still effective. Photo: B. Vint*





To evaluate how traditional and alternative wall systems and buildings perform structurally and thermally, testing and modeling were performed on material samples and buildings. By measuring their physical characteristics, we can reach useful conclusions regarding the applicability of these systems to meeting today's housing needs.

Of particular concern are earthen materials, such as adobe or rammed earth, which have historically been vulnerable to earthquakes when used in seismic zones. In recent years, research into the structural properties of earth has demonstrated methods of construction that permit the safe use of earthen walls even in earthquake zones. This requires adequate foundations, continuous bond beams at the roof level, and sufficient thickness-to-height ratios for the walls. Because straw bale is a light-weight variant of frame and plaster construction, it does not face as great a threat from lateral forces. However, it raises other concerns, in particular, the need to protect the straw from moisture and rot.

The structural analysis which follows was prepared with the advice of the structural engineer Steven Hess, with materials strength testing performed by Pattison Evanoff Engineering, both of Tucson, Arizona.

The thermal performance study investigates the effectiveness of interior conditioning strategies of vernacular houses as compared to a contemporary manufactured housing. Heat loss and gain and the effects of thermal mass walls in contrast with insulated walls are simulated using a computer modeling program, *CalPas 3*, developed by the Berkeley Solar Group.

Energy modeling and thermal performance analyses were performed by Christina Neumann, B.Arch., LEED <sup>(TM)</sup> A.P. under the direction of Dr. Nader Chalfoun. Dr. Chalfoun teaches architecture and directs the House Energy Doctor program at the University of Arizona in Tucson.



## building systems **STRUCTURAL ANALYSIS**

Traditional houses built with adobe, rammed earth or straw bale walls have withstood centuries of rain, wind, snow and even earthquakes when properly constructed. When built well, they can outlast and out perform conventional wood-frame houses.

Recent research and experience by practicing architects, engineers and builders in the U.S. Southwest have identified the most important factors in the structural stability of traditional wall materials. These factors have been codified as amendments to conventional building codes for earthen and straw bale wall systems.

The structural engineer Steven Hess, a member of the code committee which developed the Tucson/Pima County alternative materials codes, has summarized the critical engineering issues involved with traditional wall materials.



## EARTHEN WALLS

Most U.S. building codes do not specifically provide for earthen building materials. The exceptions to this rule are found in the southwestern states of California, Arizona, and New Mexico, all states with a tradition of adobe construction as a legacy of their Spanish Colonial past. Even in these states, as interest in adobe and rammed earth resurfaced in recent decades, design professionals interested in traditional materials received a cool reception from code officials.

The main stumbling block was the use of tensile design of unreinforced earth. Code officials treated adobe and rammed earth with great suspicion. Very conservative assumptions were made regarding the design properties of earth. Design strengths were assumed to be 30 psi in compression and 4 psi in shear and tension. In reality the compressive strength of adobe is typically much higher, as evidenced by testing performed for this study. Historic adobes from an 1880s era house on Court Avenue in Tucson, Arizona, averaged 177 psi in compression. Modern adobe bricks averaged from 300 for asphalt stabilized bricks, to 450 psi for cement stabilized bricks. Actual strengths can be 10 to 15 times the assumed strength. Compressed earth blocks can achieve even higher strengths and densities.

In southern Arizona, architects and engineers involved with earthen materials came together in the mid-1990s to develop an updated code provision for adoption as an amendment to the International Residential Code (IRC). The result was the joint Pima County/City of Tucson Earthen Materials Appendix Chapter

to the IRC, which subsequently has served as a model code for other communities. One of the main concessions of this model code is the "zero-tension" allowance in the design of the earthen walls.

Earthen buildings are vulnerable to lateral forces. Due to its weight, the primary threat to adobe or rammed earth structures is from earthquakes, although wind loads can be a problem for free-standing garden walls. The problem is that earth walls are monolithic and cannot readily be reinforced with tension-resisting elements. An alternate method of analyzing and resisting lateral loads is necessary.

The zero-tension approach works well for non-cantilevered building walls when it is realized that, due to an earthen wall's thickness and mass, fixity at the base of the wall is generated. Using a fixed base with a pinned restraint at the roof attachment elevation, reasonable allowable wall heights are found to be allowed within the code specified design parameters for lateral load combinations.

There are two methods for attaining a pinned restraint of a wall above the base which normally occurs at the roof. Method one is a horizontal diaphragm as traditionally found in most other buildings. Method two is the use of a horizontal bond beam spanning between cross wall supports which are normally constructed of concrete with reinforcing. Method two can be adapted to special cases where no horizontal diaphragm is available for the support of the wall, such as at gable end walls.

A prescriptive Residential Code for Earthen Materials has been written for Pima County and the City of Tucson, Arizona, which utilizes the horizontal bond beam design approach for earthen wall construction. It contains bond beam size tables based on various wind loads and Sds seismic response factors (a value based on the zip code location of the project ). A copy of the current IRC version of this code can be found at :

[http://www.cityoftucson.org/dsd/Codes\\_Ordinances/Building\\_Codes/2003\\_IRC\\_Amend\\_v1.pdf](http://www.cityoftucson.org/dsd/Codes_Ordinances/Building_Codes/2003_IRC_Amend_v1.pdf)

Engineering principles recognize that cantilevers can still be stable even if the resultant falls outside the kern. Design utilizing zero tension at the cantilever with a focus on the Factor of Safety for Overturning for the stability of the wall will produce moderate cantilevered wall heights. For cantilevered parapets, the code allows a minimum parapet height of two times the parapet wall thickness from the last wall support without calculation. Some designers avoid the cantilevered parapet by using a veneered adobe parapet backed by a braced wood stud wall.

Cantilevered adobe or rammed earth fence walls are designed for wind loads (and seismic as required) using the basic stability of the wall for overturning. It is important to have the masonry or concrete stem as thick as the wall above or if thinner, reduce the design wall width at the base of the wall. A masonry or concrete stem is required to be 6 inches above grade in order to eliminate moisture wicking from the soil below grade into the earthen materials wall. If the earthen materials wall comes in contact, or goes below grade, the moisture in the soil will be absorbed into the wall, wicked up a short distance into the wall, and then evaporate to

## STRAW BALE WALLS

the atmosphere when it gets to the surface of the wall. As the moisture evaporates, salts carried in solution re-crystallize at or beneath the surface of the earthen wall. These salt crystals expand as they form and cause the outer wall surface to spall off in layers, eventually causing a “cove” at the base of the wall. This condition is referred to as “basal coving”.

Roof joist, trusses, and beams supported by earthen walls should bear on top of the wall and as near the center of the wall as practical. Bearing loads in general should not be supported off ledgers (which will produce wall moments from the ledger eccentricity) due to the zero tension provisions of the code. The code will allow up to a 75 lbs/foot of ledger load without calculations which is intended to cover non-bearing ledger conditions or very short spans of hallways or porches. Heavy point loads should be checked for a maximum allowable bearing load of 45 psi.

The general historical earthen wall building configuration is a series of rectangular rooms placed together to form the overall building with generally small window and door openings. House plans for other materials, such as studs and stucco or reinforced masonry, frequently do not convert well to earthen material wall floor plans due to tall walls, large openings, and infrequent shear walls. With this in mind, people wishing to utilize this type of construction may be best advised to go with the most experienced and reputable designers and builders for earthen wall construction.

Straw bale construction was codified in an amendment chapter to the International Residential Code adopted by code officials in Pima County, Arizona. The Pima County Straw Bale IRC amendment can be found on-line at: [http://www.dcat.net/resources/Tucson\\_Pima\\_Co\\_SB\\_Code.pdf](http://www.dcat.net/resources/Tucson_Pima_Co_SB_Code.pdf) This local amendment has served as model straw bale code, and has been adopted in other localities where straw bale has been used.

The straw bale code is a prescriptive code for load bearing walls. It notes the characteristics for the bales relative to size, plant material, moisture content, and density. The code goes over the basic construction of a straw bale wall relative to the stacking and pinning of the walls and all other aspects of building with straw bales. The actual allowable wall heights and lengths are set by proportions and the only engineering allowable stress given is a 360 psf allowable vertical load (2.5 psi) on top of the walls.

Most engineered straw bale is post and beam type, in which the straw bales serve as infill and the structure derives no structural stability from them. Most engineers regard straw bale walls as highly compressible and not ideal to sustain long-term loadings without deforming and thereby risking damage to the structure.

The most important factor for straw bale is not compressive strength, but the moisture content of the straw. Excessive moisture will cause the straw to rot, or mold to form, causing failure of the wall system. In straw bale construction, it is essential to keep the bales dry. For this reason, parapet type roofs are not recommended. A metal roof with a deep continuous overhanging eave and gutters and downspouts is preferred to

guarantee that the water is kept away from the wall. It must be anticipated that load-bearing straw bale walls will compress under full loading over a period of from 4 to 6 weeks during construction. Protective plaster cannot be applied to the exterior until all the potential settlement has taken place.

Because straw bales weigh only 7 pounds per cubic foot (in contrast with 125 pcf for earth), dead-loads from the walls are low. The allowable roof live and dead load delivered to the top of straw bale walls is limited to 360 pounds per square foot (equaling 2.5 pounds per square inch).

Moisture content of straw bales at the time of their installation shall not exceed 20 percent of the total weight of the bale. Five bales are to be selected at random from the lot or shipment of bales to be used in construction. Testing may be performed in the field using an electric resistance moisture meter calibrated to read by percentage, with probes long enough to test the center of each bale. A testing lab may also confirm the moisture content by weighing the bales before and after fully drying them in an oven.

While straw bales vary widely in the type of straw, degree of compaction, density and moisture content, they are nonetheless a uniformly sized, mechanically bundled low-cost unit that can be readily used for super-insulating building blocks. Extra care must be taken in the erection and finishing of this system to ensure its longevity.

## MATERIAL TESTING

adobe: unamended and stabilized

TABLE 4.1: COMPRESSIVE STRENGTH OF HISTORIC ADOBE (ca. 1880)

Sample #	Area (sq. in.)	Max Load (lbs.)	Strength (psi)
1	7.26	500	131
2	9.90	650	171
3	7.70	800	210
4	8.36	750	197

Average: 177 psi

*Testing performed by Pattison-Evanoff Engineering, Tucson, AZ*

Quality control of traditional building materials can be achieved through the testing of samples by a certified testing laboratory. Representative samples should be taken at random from each production run, at a minimum of five samples from each lot. The Earthen Wall Structures amendment to the International Residential Code, as adopted in Pima County, Arizona, is referenced in the annotated bibliography. Compliance with standards must be documented. Testing for this study was performed by Pattison Evanoff Engineering of Tucson, Arizona.

Adobe samples from an historic building, circa 1880, located on North Court Avenue in Tucson were tested to evaluate the properties of adobe over the long-term. After 125 years, the samples average 177 psi in compressive strength (Table 4.1). These are traditional adobes made on site from unamended mud (without the addition of chemical stabilizers). Unamended adobes vary in weight from 110 to 125 pounds per cubic foot, depending upon the soil's clay/sand/silt distribution and resulting block density. Compressed earth blocks have characteristics similar to rammed earth.

Modern adobes, manufactured in mechanized adobe yards, are typically stabilized by the addition of asphalt emulsion or Portland cement. Greater strengths are attained by these adobes, as demonstrated at Table 4.2. The stabilized adobes sampled weigh from 115 to 120 pounds per cubic foot: weight of adobes should be verified with the local brick manufacturer.



*Cement stabilized adobe brick for testing. Photo: B. Vint*

## MATERIAL TESTING

### rammed earth

Monolithic earthen assemblies must be field-tested during construction for quality control. Following are the specifications and testing procedures for rammed earth developed by Quentin Branch of Rammed Earth Solar Homes Inc., Tucson, Arizona.

1. Soil shall contain not more than 0.2% soluble salts by volume.
2. Soil shall be stabilized with a minimum of 5 percent Portland cement by volume. Sulfate-resistant cement shall be used in regions with high gypsum soil content.
3. The following procedures shall be used to demonstrate compliance with the Earthen Wall Structures, IRC 2000 Section R614:
  - A. Soil will be tested from the on-site stockpile as it is being used.
  - B. Three specimens will be molded from each 40 tons of earth materials prepared for placement in the walls. One will be moist-cured for 7 days and air dried for 7 days, and will exceed 300 psi when broken. The second sample will be moist-cured for 14 days and air-dried for 14 days, and will exceed 500 psi when broken. The third specimen will be retained for confirmation of 500 psi, if necessary.

TABLE 4.2: COMPRESSIVE STRENGTH OF MODERN ADOBE (2004)

A. Cement Stabilized (made by Tucson Adobe West)

Sample #	Area (sq. in.)	Max Load (lbs.)	Strength (psi)
1	26.23	12,066	460
2	26.57	11,956	450
3	25.51	13,265	520
4	12.55	5,898	470
5	12.73	4,837	380

Average: 456 psi

B. Asphalt Stabilized (made by Old Pueblo Adobe, Tucson)

Sample #	Area (sq. in.)	Max Load (lbs.)	Strength (psi)
1	26.32	7,369	280
2	26.24	8,134	310
3	29.78	8,934	300

Average: 297 psi

*Testing performed by Pattison-Evanoff Engineering, Tucson, AZ*

- C. Soil will be tested in accordance with ASTM D558 (Moisture Density of Soil Cement Mixtures) or ASTM D698.
  - D. A sand-cone density or nuclear back-scatter test will be performed in the wall. The finished wall must exceed 95 percent relative compaction.
  - E. Copies of the engineering testing laboratory reports shall be attached to the inspection card at the construction site for the building inspector's review.
4. Rammed earth weighs between 123 and 127 pound per cubic foot (average 125 pcf).

A shared characteristic of earthen building materials is that when wet both rammed earth and adobe lose strength. The degree to which moisture affects compressive strength is demonstrated at Table 4.3. Earthen walls may be protected against the deleterious effects of water by cement stabilization or by coating with a compatible plaster.

**TABLE 4.3: COMPRESSIVE STRENGTH OF RAMMED EARTH – DRY & WET**  
*(made by Rammed Earth Solar Homes, Inc. of Tucson)*

Sample #	Area (sq. in.)	Max Load (lbs.)	Strength (psi)
1 (Dry)	12.42	3,974	320
2 (Wet*)	12.56	1,382	110

Average: 215 psi

\* Soaked for 4 hours

*Testing performed by Pattison-Evanoff Engineering, Tucson, AZ*



*Rammed Earth test cylinders. One loaded to failure dry. One loaded to failure wet. Photo: B. Vint*



# THERMAL PERFORMANCE ANALYSIS

Indigenous inhabitants of the US/Mexican deserts relied on their instincts to inform themselves about their regional climate to obtain *thermal comfort*, or that state of contentment a body desires within its thermal environment. From Acoma Pueblo to the Gray Ranch, the vernacular examples profiled in *Ch. 2, Design*, feature regional building adaptations that represent a thousand years of research and evolution. These peoples did not have a constant stream of harnessed energy to power mechanical conditioning devices, such as air conditioners or gas furnaces. Instead, they developed building techniques that demonstrate resourceful use of natural forces and materials for passive heating and cooling, such as *solar orientation, thermal storage mass walls, earth cooling, evaporative cooling, vegetated and built shade devices, and natural ventilation.*

Energy-efficient construction and adaptable operational techniques which evolved from the local climate to gain a greater level of thermal comfort are called *passive conditioning* strategies. Since these strategies emphasize thermal comfort with minimal or no energy consumption, they hold important lessons to apply to contemporary affordable housing design. The following section is an investigation of the effectiveness of US Southwest regional passive strategies. It focuses on predicting the thermal efficiency of some pre-selected urban and rural vernacular examples as a function of the site features, building form, and building envelope. *Thermal performance will be measured by the efficiency of the building enclosure to provide thermal comfort rather than the more typically chosen analysis of mechanical heating and cooling loads.* Both urban and rural vernacular houses have been analyzed through field testing and computer energy simulation as separate cases, due to climatic differences between their locations. The urban case is the Fish Stevens Duffield House of Tucson, Arizona, and the rural case is the Upshaw House on the Gray Ranch near Animas, New Mexico. The emphasis here is on strategies that vernacular builders employed for passive conditioning. The performance of these traditional houses will be compared to that of a contemporary manufactured house. The affordability of a house depends on the operational costs for utilities and maintenance over the lifetime of the housing unit, or *lifecycle cost* as much as the initial purchase cost, or *first cost.*

*CalPas 3* is the software used for the energy simulation. Supplemental information on this software can be found in the *Appendix* (see p. 199). Although it is a common practice to use computer simulation to predict heating and cooling loads based on pre-set summer and winter interior temperatures, simulation of traditional buildings is different. Analysis of interior conditions without use of any mechanical system for conditioning requires simulation that will shift the focus to predicting interior “floating” temperatures as related to human thermal comfort. This way, researchers can determine the effect of the building envelope and its role in passively creating a comfortable indoor environment, particularly during summer and winter which are times of seasonal and diurnal climatic extremes. These are the most difficult times for low-income families on a fixed budget who may find themselves with excessively high heating and cooling bills.



## DESERT CLIMATE FEATURES

The climate of the U.S./ Mexico border is most characterized by extremes, in both temperature and precipitation cycles. The predominant climatic zone of this region is the semi-arid desert most typified by the following two features:

- Rainfall** averages 10-12" per year typically occurring 40-50 percent in the summer monsoon season and 50-60 percent throughout winter after long periods of drought. The landscape is dappled with mountainous regions which create points for condensation thus producing rain. Moisture from the intense summer storms comes northwest from the Gulf of Mexico in Mid-July to September. The winter rains (November to March) originate in the Pacific and produce snows above 6,000 feet. These snows are an extremely important form of natural water storage releasing much needed water during the dry seasons. 80 to 95 percent of the annual stream flow produced is from the winter rains.

- Blackbody Raditation:** cloud formation for shade can create large temperature swings from day to night. During all seasons, swings of 32°F or more are common. As the heat of the day builds up, the sparse ground cover, which is typically light in color, creates a high amount of reflectance. Thus, there is little capacity for heat retention so a large portion of the daily heat gain radiates back into the coolness of cloudless the night sky.

## TEMPERATURE

NOAA 30 Year Monthly Averages, Tucson, AZ

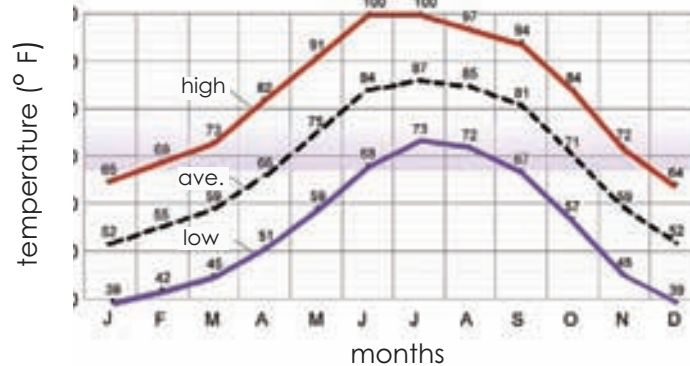

Graph of monthly average maximum and minimum temperatures demonstrates great range of temperatures over the course of the year. Winters tend to be a bit more mild than summers in terms of temperature extremes from human comfort.

## PRECIPITATION

NOAA 1971-2000 Monthly Averages, Tucson AZ

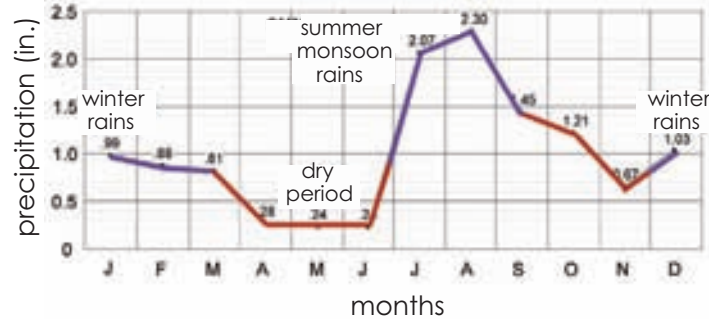

Graph of monthly precipitation averages shows the two peak times of rainfall in both the late summer and early winter. The driest period is from March to Mid-July.

## DIURNAL SWING

2003 NWS Hourly Temperatures, Tucson AZ

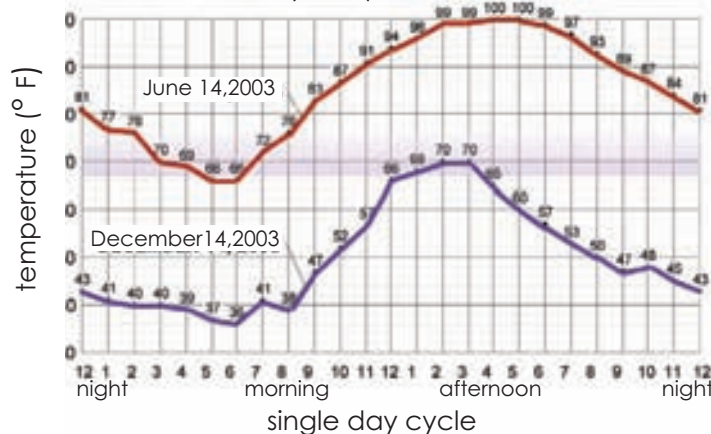

Graph demonstrates the large temperature swing from day to night, typically around 32°F in both summer and winter. This temperature fluctuation is called diurnal swing and is due to the lack of humidity in the air and clearness of the night sky.

## DESERTS OF THE US/ MEXICO BORDER REGION

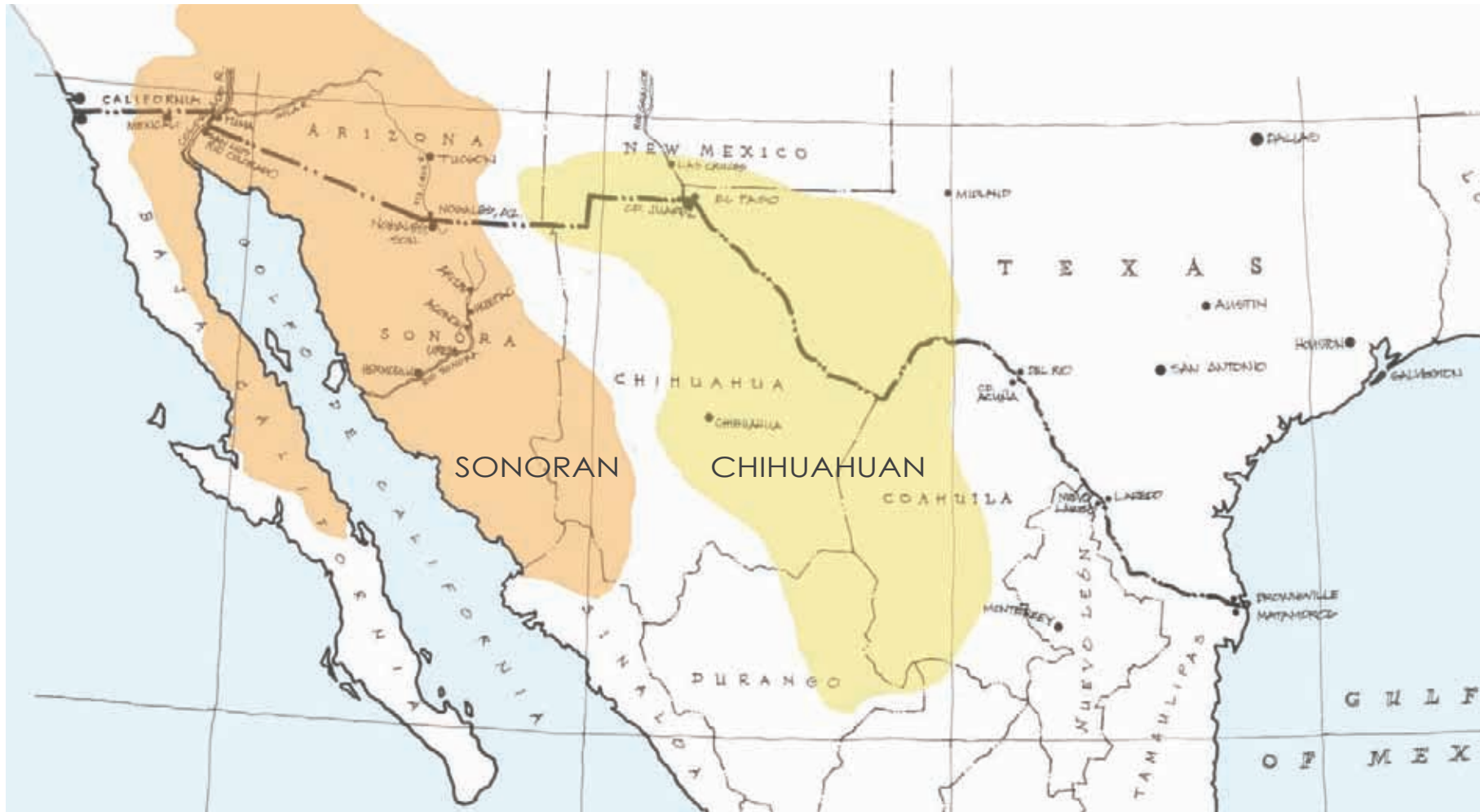

 *Sonoran Desert:*  
120,000 sq. miles

 *Chihuahuan Desert:*  
200,000 sq. miles

## ARID CLIMATE BIOCLIMATIC ADAPTATIONS

*“The steady-state approach to the thermal environment assumes that any degree of thermal stress is undesirable. A constant temperature is maintained in order to save people from the effort and the distraction of adjusting to different conditions. And yet, in spite of the extra effort required to adjust to thermal stimuli, people definitely seem to enjoy a range of temperatures. Indeed, they frequently seek out extreme thermal environment for recreation or vacations... Americans flock to beaches in the summer to bake in the sun and travel great distances in the winter to ski on frosty mountain slopes. People relish the very hotness or coldness of these places (Moore, 32).”*

Bioclimatic design is the development of habitat which takes into consideration environmental variables like dry bulb temperature, relative humidity, air movement and radiation to human perception and response (Peyush Agarwal, University of Arizona, 1998). The correct balance of these variables create a state of thermal comfort. If you're a lizard, it may mean sitting in the warm afternoon sun to heat your cool reptilian body. Yet in the same conditions, a human may be wanting to keep cool by sitting close to a water body (aka. the pool).

Approximately 2,500 species inhabit the Sonoran Desert, alone. The border region also encompasses the Chiuauan Desert. This wealth and diversity of plant and animal life in the border region proves that natural strategies to protect from the extremes of the climate have been effective for thousands of years. Many desert creatures are less active by day and increase their activity at night and early morning when their bodies will work more efficiently. The siesta, or period of rest from early afternoon until evening, is a cultural practice in many warm regions. By being active during cooler times, excess energy is not needed to condition enclosures. In addition, traditional clothing is often loose and light in color to limit dehydration via perspiration and minimize solar absorption.

### NATIVE SHELTER

To temper severe exterior conditions, a heavy barrier is one of the most effective strategies. The relatively high thermal capacity of thick earth walls help moderate the interior temperature by retarding heat flow and retaining occupant humidity and act as a heat sink. Pack rat holes, desert tortoise burrows and adobe homes all function in this manner. According to Alexis Karolidis of the Rocky Mountain Institute, the Mexican settlers of San Luis Valley, CO, gauged the thickness of their adobe home's walls by the depth of local ground squirrel holes.



*The desert tortoise dwells in earthen burrows where it can be protected from extreme ground surface temperatures that range from freezing to 160 °F. The natives of Sierra Ancha (east Arizona) built stone and earthen burrows within the cliffs.*



*Photos: (l.)USGS- Curtis Bjurlin, photographer (r.) B.Vint*



*Shelter producing shade is essential for desert survival as it prevents excess water loss by transpiration and overheating. The spines of the hedgehog cactus provide the same function as the woman's umbrella, subduing the direct sunlight.*



*Photos: (l.)C.Neumann (r.)B.Vint*

# REGIONAL STRATEGIES FOR PASSIVE CONDITIONING

## BUILDING ENCLOSURE

### ■ *thermal mass and wall thickness*

Thermal tempering technique which uses high mass materials with greater thermal storage capacity (traditionally adobe or stone) to absorb and hold thermal energy therein creating a thermal barrier. This technique works most effectively in a diurnal (24 hour) cycle when there is a great temperature differential (32°F) from night to day due to the aridity. In summer months, the massive walls create a cooler more thermally comfortable interior, maintaining a space temperature lower than skin temperature during times of day when solar heat gain is most intolerable.

### ■ *the diurnal cycle (in cooling)*

Noon- *Mass walls are absorbing heat from day.*

*Interior temperatures of home are still very cool.*

6 pm- *Mass walls closer to heat storage capacity.*

*Interior temperatures of home have risen but still are thermally tolerable, as compared to outside conditions.*

Midnight- *Exterior surface temperatures are dropping as heat is being released into night sky. House should be opened for natural ventilation to cool down interior discharging heat from massive walls.*

6 am- *Walls and interior space have released stored heat from previous day into cool night sky.*



\*see Ch.2, Design:

*Casa Grande, Court Ave., Casa Cordova*

## BUILDING FORM

### ■ *surface area and shared walls*

A technique to increase thermal efficiency of enclosure is by decreasing the surface area of the thermal barrier in relation to its volume. This is a traditional technique in extreme climates, both warm and cold, and often several living units are attached by shared walls. The *S.V.R.* or Surface to Volume Ratio is one way to measure this efficiency.

$$s.v.r. = s.f. (exterior) / c.f. (gross)$$

\*see Ch.2, Design:

*Acoma Pueblo, Court Ave.,  
Fish Stevens Duffield House, Empire Ranch*



### ■ *windows: size, location and shading devices*

Openings in the building enclosure allow the modulation of solar gain and natural ventilation. Size is an important variable. Oversized windows may allow unwanted heat gain in summer while undersized windows will impede the cooling effects of natural ventilation and passive solar gain for warmth in winter. Orientation of windows is important as well since both cross (across space) and stack (from low to high points in space) ventilation become more effective when windows are aligned with prevailing winds. Shading devices, such as overhangs, light curtains, and shutters work, in passive cooling to modulate light and ventilation but prevent intense direct solar gains in warm months.

\* see Ch.2, Design:

*Court Ave., Gray Ranch  
Fish Stevens Duffield House, Bungalow*



## SITE FACTORS

### ■ *solar orientation*

Positioning of the building to optimize solar gain during winter and minimize solar gains during summer. In the US/Mexico border region, a south orientation for the length of the house is best for passive conditioning in all seasons. In winter, thermal mass on the interior of the house helps to absorb heat and keep interior conditions comfortably warm when it is cold outside (see “thermal mass and wall thickness.”)



\*see Ch.2, Design:

*Acoma Pueblo, Gray Ranch*

### ■ *vegetative barriers and site microclimate natural evaporative cooling and ventilation*

Arrangement of the building components to expose a significant amount of the living spaces to a thermal buffer zone. In traditional building, the courtyard normally functions to create a vegetated microclimate which provides cooling via shade and humidity. The shade provided by the vegetation allows for a greater number of larger openings which help to vent the interior of the house and the thermal mass at night. The courtyard also provides a secure place to sleep at night when the house is releasing the heat from the day and the interior spaces may be uncomfortably warm for occupants.



\* see Ch.2, Design:

*Casa Cordova, C.O. Brown  
Fish House (Fish Stevens Duffield House)*

## INTERPRETING THE RESEARCH

### thermal performance analysis

Most results of this study are displayed in the form of graphs, such as the example at right, which chart each modeled building's monthly interior temperature over the course of a year. The emphasis is upon analyzing bioclimatic data, mainly high, low, and mean interior temperatures, as opposed to the more conventional approach with predicted energy loads. These loads are created by mechanical systems which keep the building interior at constant temperatures within the typical human comfort zone. As defined by the American Society of Heating, Refrigerating, and Air-Conditioning Engineers (ASHRAE) Standard 55-74, the human comfort zone range is from 68-76 °F pending these conditions are met:

- Mean Radiant Temperature (MRT) equals Dry Bulb Temperature (DBT)
- Still Air Condition equals 0.2 m/s (40 ft/min.)
- Relative Humidity is 30%- 60%
- Occupant is sedentary, normal dress

This human comfort zone is represented by the purple band in the graphs, as in the example to the upper right. The psychrometric chart to the lower right is another bioclimatic analysis tool which combines the predicted mean interior temperatures (dry bulb temperature) with other data such as wet bulb temperature and relative humidity to define human thermal comfort conditions and strategies to extend this zone. These strategies include passive solar heating, natural ventilation, evaporative cooling, high mass cooling in addition to mechanical heating and cooling. Overall, the study's approach to measure predicted mean interior temperatures allows analysis of the building's thermal performance by passive means as it traditionally functioned to condition the interior spaces.

### EXAMPLE GRAPH

mean monthly temperatures

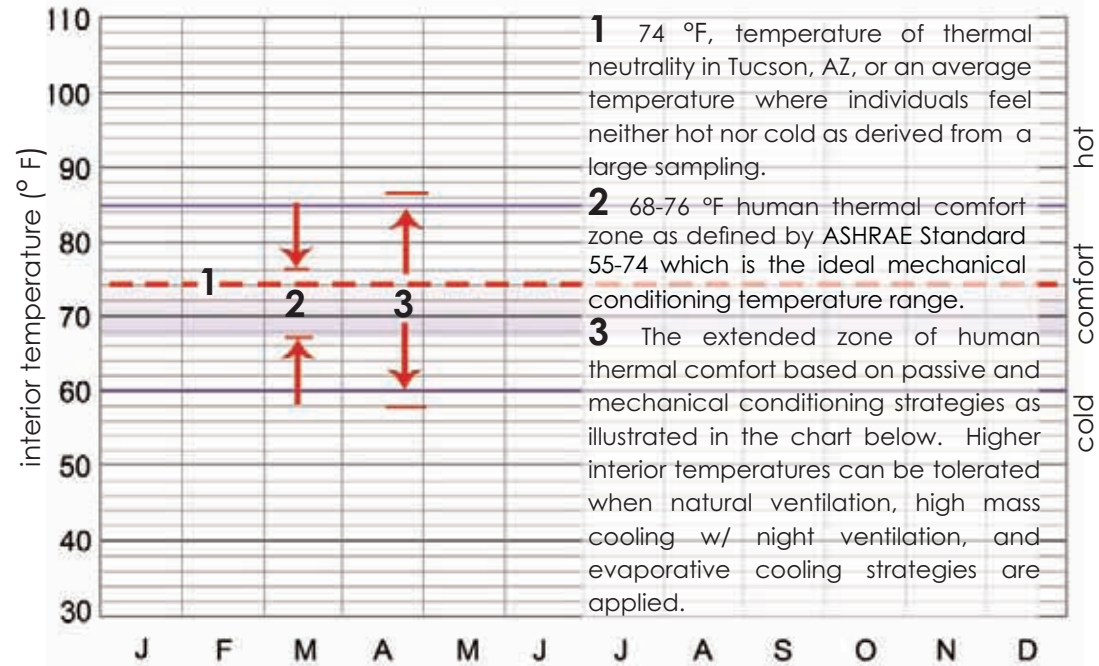

### PSYCHROMETRIC CHART

combined bioclimatic data

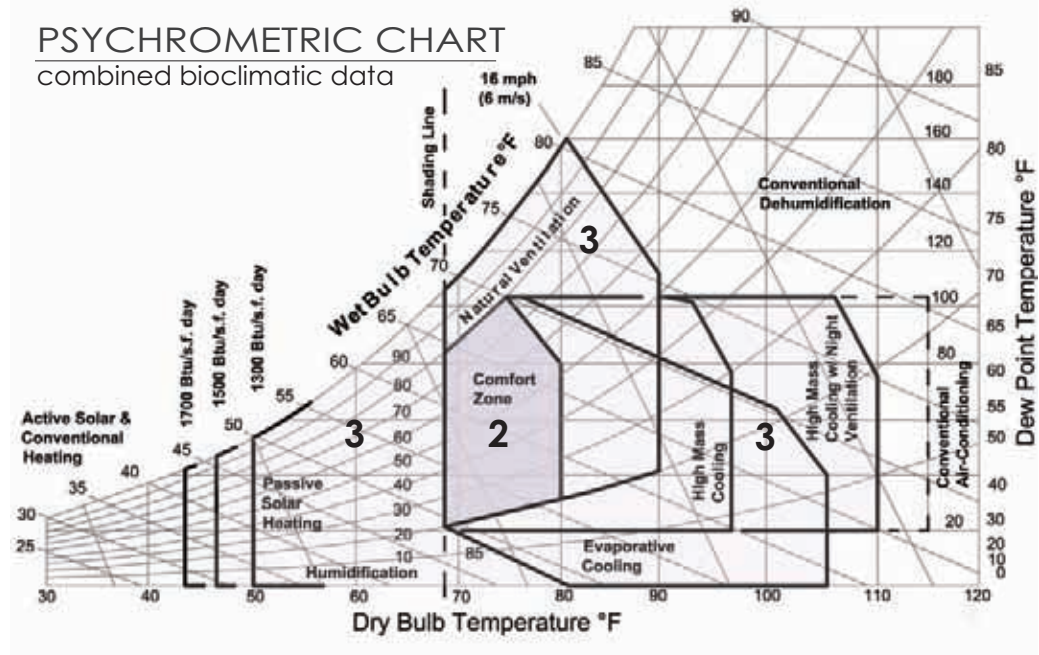

## BASE CASE ANALYSIS

### manufactured house

The base case is a manufactured house to be compared with the traditional urban and rural housing examples. This house, located in Tucson, AZ, is a 2x4 wood frame 1659 s.f. manufactured house with light grey vinyl exterior siding and asphalt shingle roofing.

Wood framed buildings, such as this base case, are classified as *low mass construction* since they are primarily composed of low density and low conductivity materials, such as vinyl paneling, wood studs, fiberglass insulation, and gypsum panel board. Adobe and concrete block buildings are of *high mass construction* and have a thermal storage capacity anywhere from eight to forty-five times that of wood. Adobe block has 680 times the thermal storage of fiberglass (Moore, 12). Low mass systems maintain interior conditions by creating a thermal barrier instead of absorbing heat like a high mass system. Therefore, it makes no difference if an insulated or uninsulated house is used for comparison purposes to the traditional high mass buildings in this study, since both conditions represent low mass construction (see similar results to graph at right). The study seeks to measure efficiency of passive conditioning techniques, particularly mass effect and natural ventilation in an arid climate.

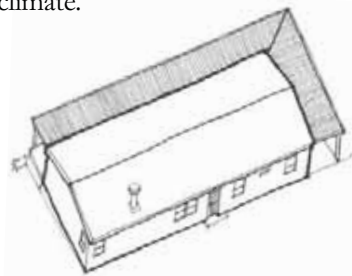

\*For scaled house plans and supplemental information, such as area and volume, see Appendix.



Aerial Site Photo: Pima County Maps Dept.



Base case South Elevation Photo: C.Neumann

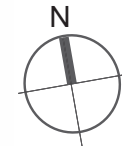
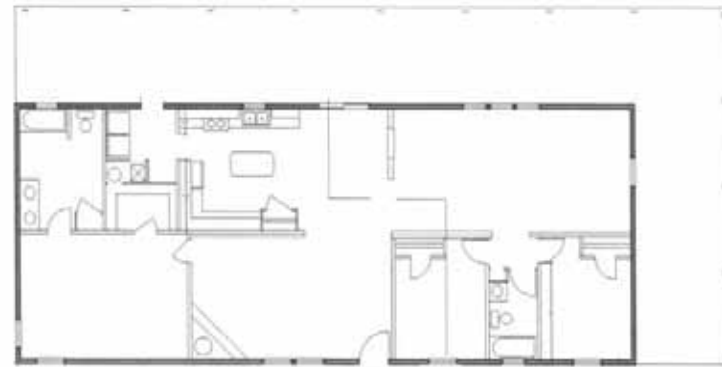

Base Case Plan.

## MANUFACTURED HOUSE

base case mean monthly temperatures

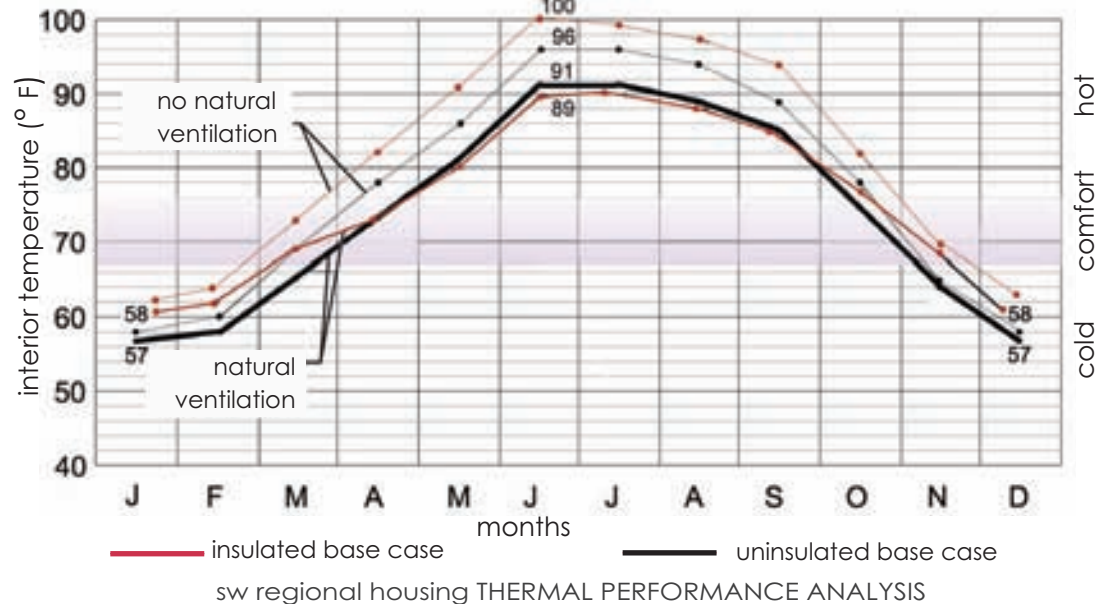

# CONDUCTIVITY AND HEAT RESISTANCE

## R ROOF- NOT INSULATED

	BTWN RAFTER (90%)	@ RAFTER (10%)
INSIDE SURFACE	0.62	0.62
5/8" GYPSUM BOARD	0.56	0.56
1/2" PLYWOOD	0.63	0.63
NOMINAL 2x6 RAFTER	---	5.22
6" FIBERGLASS BATT INSUL.	---	---
PLYWOOD SHEATHING	0.61	0.61
PERM.FELT MEMBRANE	0.06	0.06
ASPHALT SHINGLE ROOFING	0.44	0.44
OUTSIDE SURFACE	0.17	0.17

TOTAL R: 3.09

8.29

AVE R = 3.61

**U= 0.28**

## R WALL- NOT INSULATED

	BTWN STUDS (92%)	@ STUDS (8%)
INSIDE SURFACE	0.62	0.62
5/8" GYPSUM BOARD	0.56	0.56
1/2" PLYWOOD	0.63	0.63
NOMINAL 2x4 STUD	---	4.35
6" FIBERGLASS BATT INSUL.	---	---
PLYWOOD SHEATHING	0.61	0.61
VINYL PANELING	0.61	0.61
OUTSIDE SURFACE	0.17	0.17

TOTAL R: 3.20

7.55

AVE R = 3.55

**U= 0.28**

\* NOTE: U-VALUE FOR SINGLE PANE VINYL WINDOW= 0.5  
ACCOUNTED FOR IN CALPAS 3 AS SEPARATE ELEMENT FROM ROOF,  
WALL, OR FLOOR.

## R FLOOR- NOT INSULATED

	BTWN TJI (96%)	@ RAFTER (4%)
INSIDE SURFACE	0.62	0.62
CARPETING W/ RUBBER PAD	1.23	1.23
1/2" PLYWOOD	0.63	0.63
16" DEEP TJI	----	16.0
6" FIBERGLASS BATT INSUL.	----	----
OUTSIDE SURFACE	0.17	0.17

TOTAL R: 2.65

18.36

AVE R = 3.29

**U= 0.30**

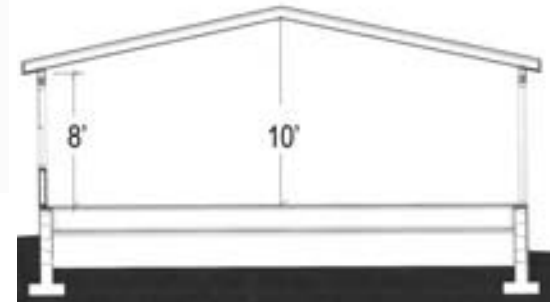
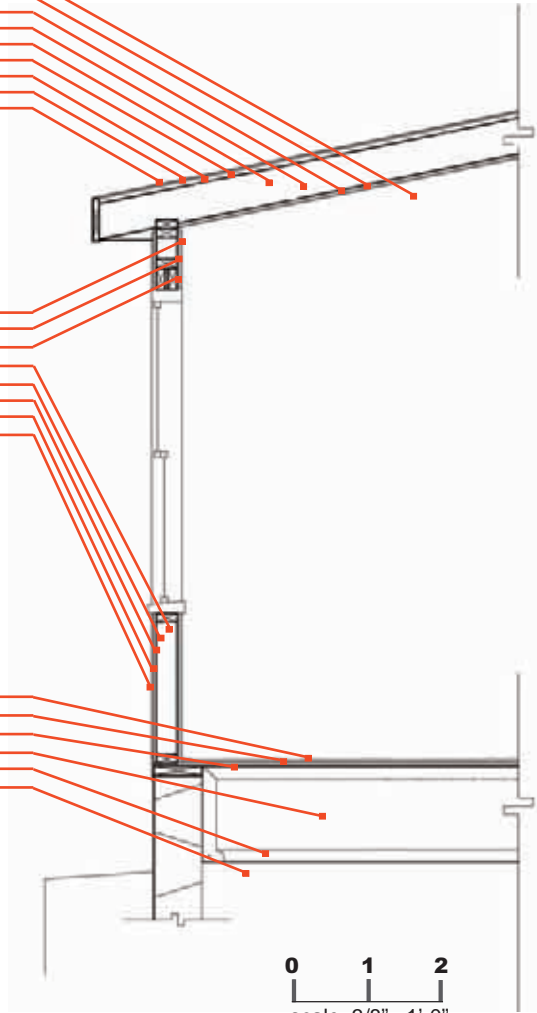

## MANUFACTURED HOUSE TYPICAL WALL SECTIONS

*base case building section*



## ANALYSIS #1

### urban adobe house

The Fish Stevens Duffield House in Tucson, Arizona is the urban study case to be compared with the standard manufactured home base case. Urban climates are typically characterized by the following features:

- *Elevation:* Traditionally, urban centers naturally developed around water sources both for agriculture and trade. In the case of many border cities such as Tucson (2400 ft above sea level), these water sources are at lower elevations as compared to rural regions. As a rule of thumb, temperatures will rise in summer by 1°F for each 330 ft elevation drop, or *adiabatic lapse rate* (Moore, 57).
- *Heat island effect:* Due to the prevalence of concrete and asphalt paved area which retain heat, and the lack of ground cover and vegetation, little humidity is retained and temperatures are higher.
- *Terrain friction and windbreaks:* Urban obstructions, which include buildings and street trees reduce wind speeds which can be a hindrance to cooling in summer but help elevate temperatures in winter to aid in heating. Greater building density dramatically changes wind patterns at ground level.
- *Building density and configuration:* Produces distinctly different microclimates in traditional urban centers. Entire blocks of housing dating to historic Territorial era construction (1850s-1920s) exhibit shared mass walls. This situation can make passive cooling via natural ventilation more challenging but can lower energy costs since surface area of individual units is reduced. In addition, window opening and placement may be decided with respect to the urban context for or security.

## TEMPERATURE

NOAA 30 Year Monthly Averages, Tucson, AZ

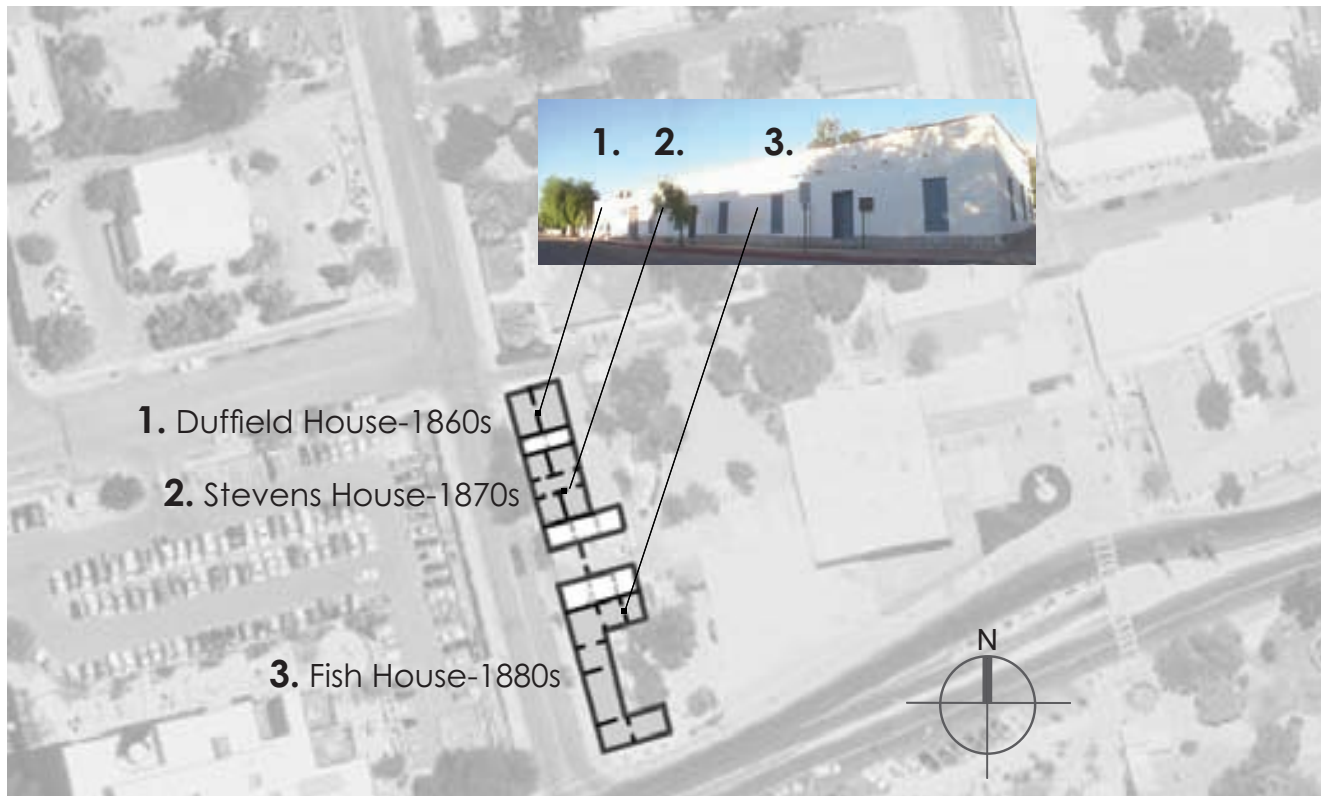
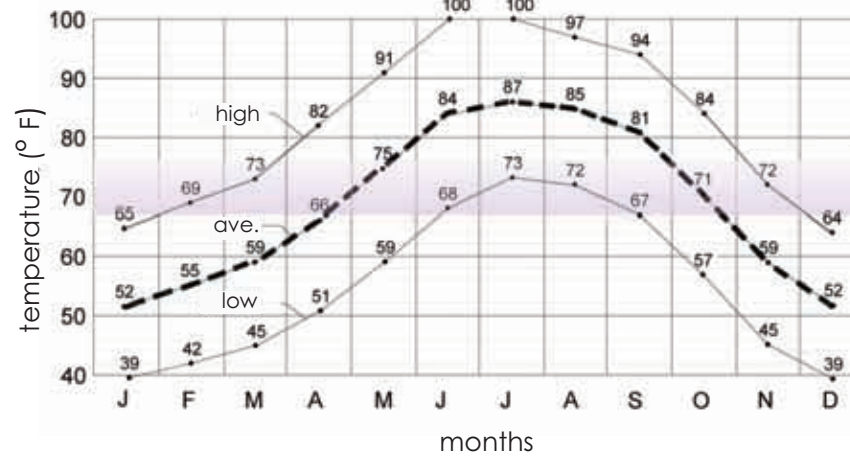

Aerial view of Fish Stevens Duffield House in the center of Downtown Tucson. Pima County Maps Dept.

## TRADITIONAL URBAN FORMS

These individual unit plans are all part of the Fish Stevens Duffield House in the historic El Presidio Neighborhood of Tucson, Arizona. Each of these individual units correspond with the urban vernacular archetypes presented in *Ch 2, Design*. The wall and sub-roof is composed of high mass adobe as demonstrated in the building section on the next page which is a typical condition for all three houses. The 675 s.f. Duffield House, dating to the 1860s, is a two-room adobe structure and basically determined the orientation, height, and width of the subsequent attached houses. The placement of this house on a north-south axis, with its primary entrance opening to Main Avenue, was based upon the urban street layout.

The 1020 s.f. Stevens House, with its central hallway, exemplifies the *zaguán* plan (see *Ch.2, Zaguán House*) and was connected as an addition to the Duffield House in the 1870s.

Finally, the 2136 s.f. Fish House was added to the complex in the 1880s and is typical of a courtyard house which accommodates a courtyard on the east side. All are composed of 20"-24" thick exterior adobe walls, 16" interior adobe walls and have an earth and saguaro rib ceiling below a built-up roof system which was added in the 20th Century. Windows are wood-framed, single-pane double-hung with louvered shutters on the exterior and light curtains. The concrete floors are also a 20th Century addition. The section on the next page shows in detail the material composition.

*\*For scaled house plans and supplemental information, such as conditioned area and volume, see Appendix.*



Duffield House 1860s Adobe Row House



Stevens House 1870s Adobe Zaguán

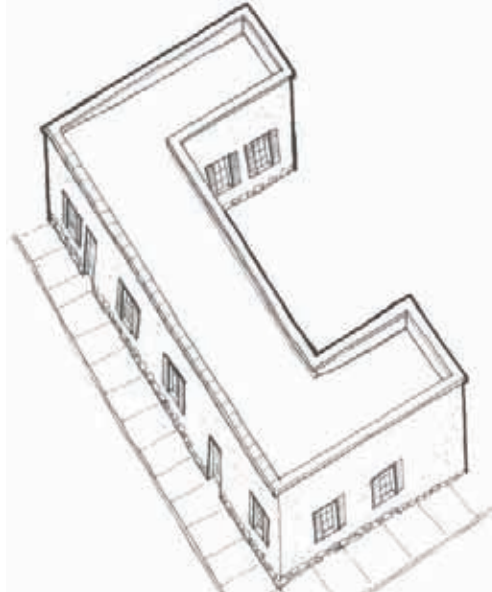

Fish House 1880s Adobe Courtyard

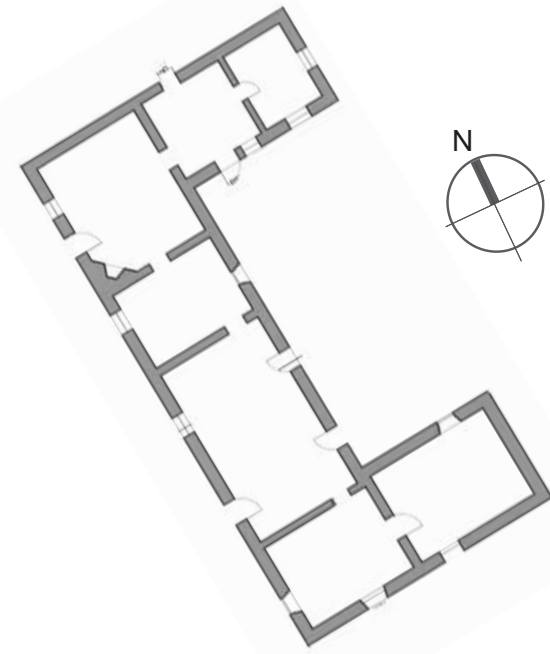
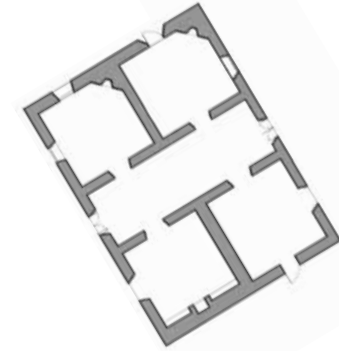
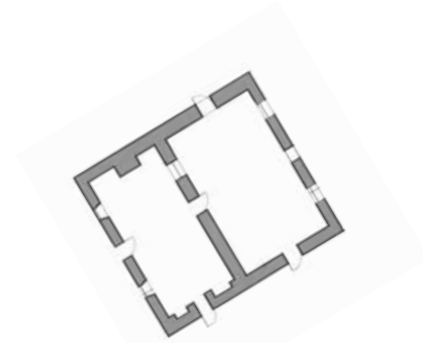

# CONDUCTIVITY AND HEAT RESISTANCE

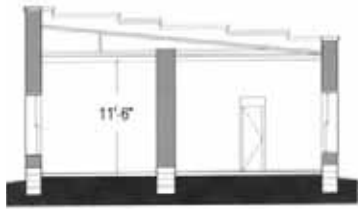

*Duffield house section*

## U ROOF- BUILT-UP ROOFING ABOVE ORIGINAL EARTH ROOFING

	BTWN RAFTER (90%)	@ RAFTER (10%)
OUTSIDE SURFACE	0.17	0.17
SILVER PAINTED BUILT-UP ROOF	0.33	0.33
3/4" PLYWOOD SHEATHING	0.93	0.93
ROUGH SAWN 2x6 RAFTER	--	6.11
6" EARTH ON SAGUARO RIB	1.74	1.74
6" TIMBER BEAM	--	6.11
INSIDE SURFACE	0.62	0.62

TOTAL R: 3.79                      16.01

AVE R = 5.0

**U = 0.2**

## U WALL- UNINSULATED PLASTERED ADOBE

INSIDE SURFACE	0.62
1" LIME PLASTER SURFACE	0.61
22" UNSTABILIZED ADOBE	----
1" LIME PLASTER SURFACE	0.61
OUTSIDE SURFACE	0.17

TOTAL R: 2.01

**U = 0.51**

ADOBE SPECIFIED HAS A VOLUMETRIC HEAT CAPACITY OF 25 BTU/CF-F AND CONDUCTIVITY OF 0.30 0 BUTH-FT/S.F.-F. U-VALUE FOR SINGLE PANE VINYL WINDOW= 0.5 ACCOUNTED FOR IN CALPAS 3 AS SEPARATE ELEMENT FROM ROOF, WALL, OR FLOOR.

## U FLOOR-

4" CONCRETE SLAB FACTORED AS MASS ELEMENT IN CALPAS 3 UNDER THE "SLAB" COMMAND. THE DENSITY OF THE STANDARD CONCRETE SPECIFIED IS 140 LBS/ CF. VOLUMETRIC HEAT CAPACITY IS 28 BTU/CF-F AND CONDUCTIVITY IS 0.980 BTUH-FT/ S.F.-F. NO CARPETING IS APPLIED TO THIS SURFACE.

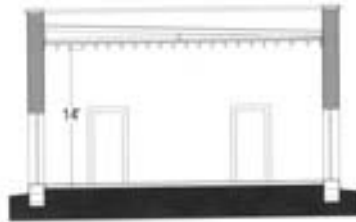

*Stevens House Section*



*Fish House Section*

0    1    2  
 scale 3/8" = 1'-0"

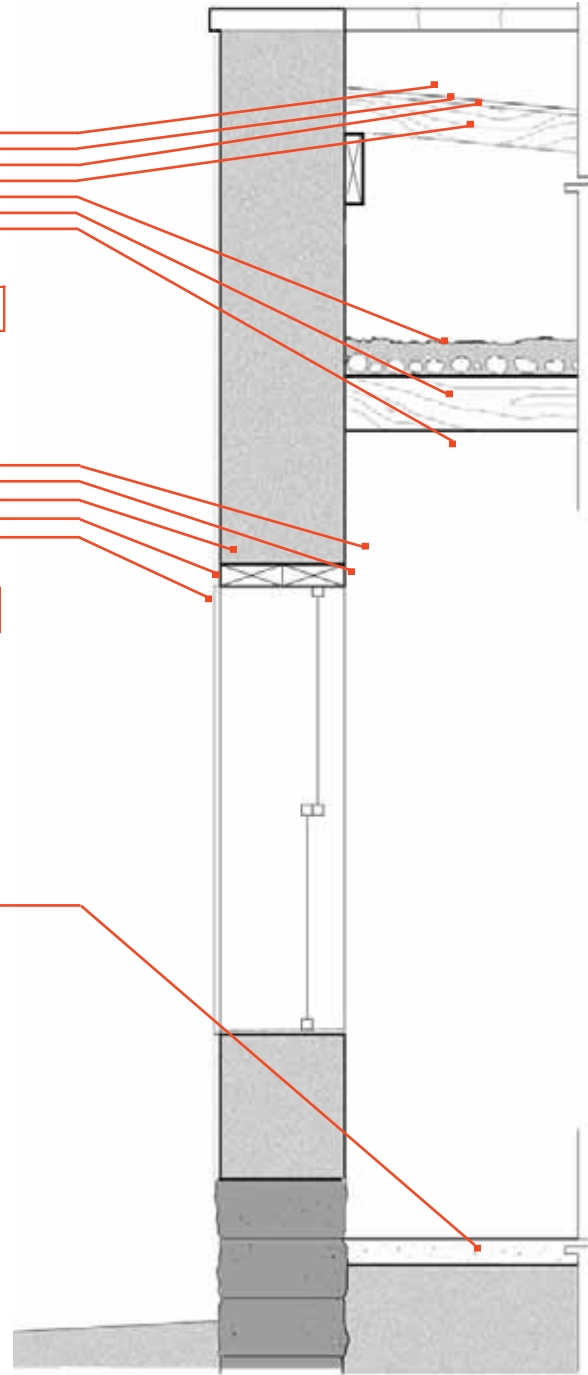

## URBAN ADOBE TYPICAL WALL SECTIONS

## EFFECT OF BUILDING FORM

■ *investigation summary:* Analyze thermal performance as a function of monthly mean interior temperature for manufactured housing base case and three urban adobe cases.

■ *investigation results:* Although variables such as square footage and orientation vary between the base case and urban cases, the results indicate the relative effectiveness of combined thermal mass, natural ventilation and shutters. All three urban cases are predicted to perform better than the base case in both passive heating and cooling. Interestingly, all adobe cases will reach a peak interior temperature a month after the base case demonstrating their ability to delay heat gain. The Duffield House performs best in passive heating by 2-6°F while the Fish House is best in cooling by 2-4°F. The compact form of the Duffield and Stevens Houses is effective in passive heating unlike the thin form of the Fish House, which accommodates an east courtyard, and allows for more wall/window surface area. In the buildings historical state (no thermally engineered windows, doors and roof) this building form is an asset in passive cooling but a liability in passive heating with the building's current north-south orientation.

## MEAN MONTHLY TEMPERATURE COMPARISON

Fish Stevens Duffield Houses vs. Manufactured House

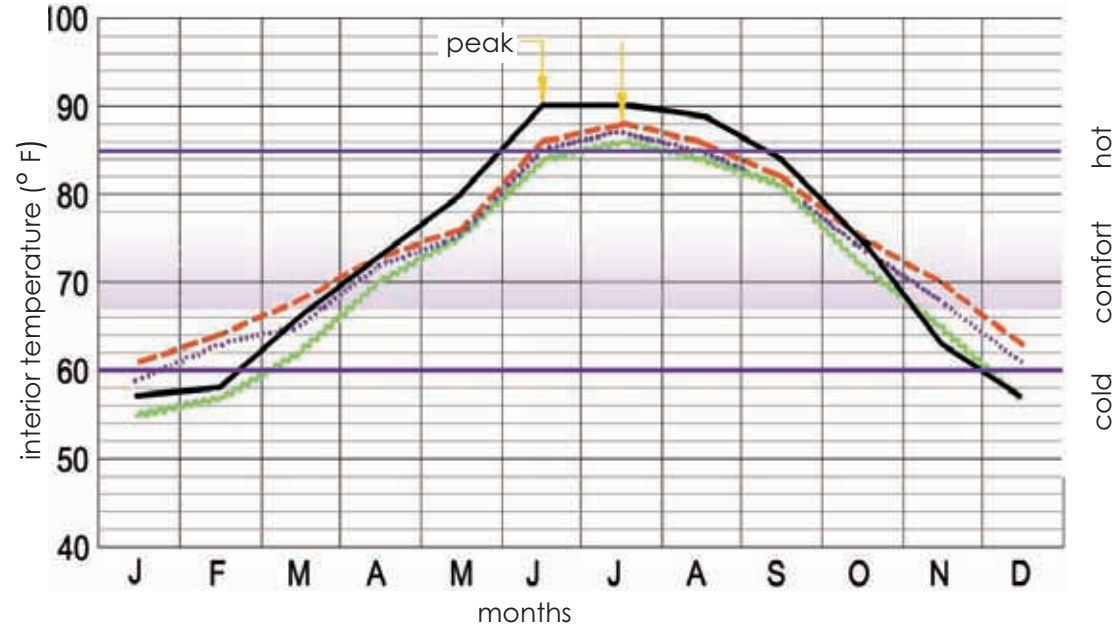

— 1659 s.f. s.v.r.\* = 17%  
base case  
manufactured house

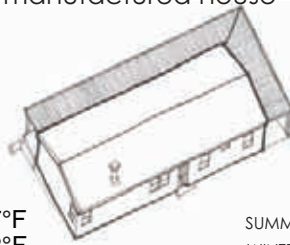

SUMMER HI: 107°F  
WINTER LOW: 42°F  
% YEAR - COMFORT ZONE : 15%  
% YEAR - EXTENDED COMFORT ZONE : 54%

- - - 675 s.f. s.v.r.\* = 17%  
Duffield House

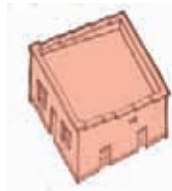

SUMMER HI: 91°F  
WINTER LOW: 59°F  
% YEAR - COMFORT ZONE : 32%  
% YEAR - EXTENDED COMFORT ZONE : 83%

..... 1020 s.f. s.v.r.\* = 28%  
Stevens house

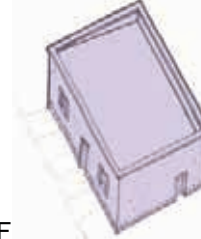

SUMMER HI: 92°F  
WINTER LOW: 53°F  
% YEAR - COMFORT ZONE : 23%  
% YEAR - EXTENDED COMFORT ZONE : 81%

~~~~~ 2136 s.f. s.v.r.\* = 31%  
Fish house

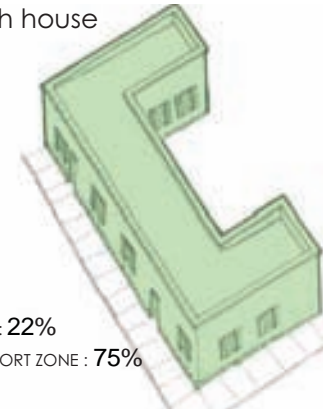

SUMMER HI: 89°F  
WINTER LOW: 55°F  
% YEAR - COMFORT ZONE : 22%  
% YEAR - EXTENDED COMFORT ZONE : 75%

\* s.v.r. = Surface to Volume Ratio, see p. 129

## EFFECT OF SOLAR ORIENTATION

### ORIENTATION

Duffield House- west face reoriented to south

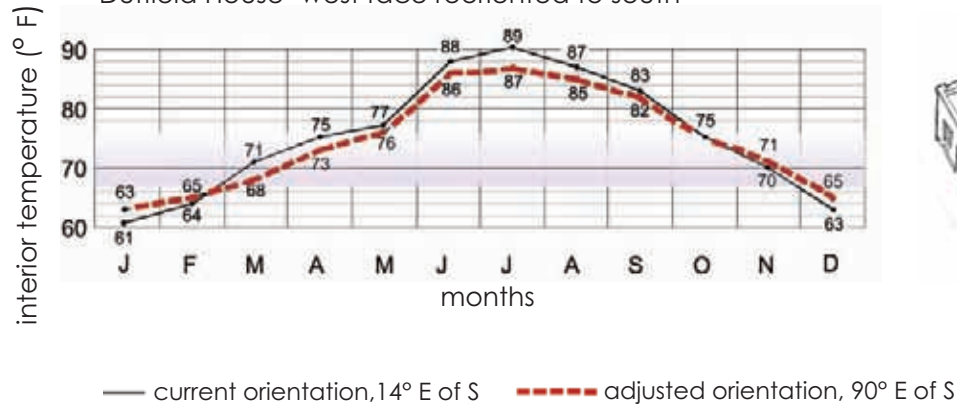

■ *investigation summary:* Analyze thermal performance as a function of monthly mean interior temperature when west faces of urban cases area reoriented to the south.

■ *investigation results:* In the case of the Duffield House, reorientation is predicted to improve passive cooling by reducing peak temperatures in summer by 2°F. Passive heating improves as well with temperatures rising 2°F in winter.

For the Stevens House, temperatures drop in summer by 4°F and rise in winter by 1°F. While the Fish House showed the greatest improvement in passive cooling, dropping 3°F in summer, no change is predicted in winter. The Fish House may benefit by having a greater amount of south facing glazed area in proportion to the amount of mass wall and a seasonal shading strategy to prevent direct gains in summer.

### SHARED WALLS AND ENERGY CONDUCTION

Stevens House- effect of shared North and South Walls

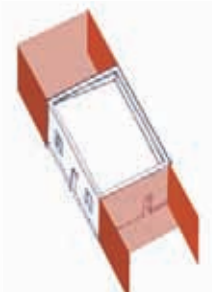
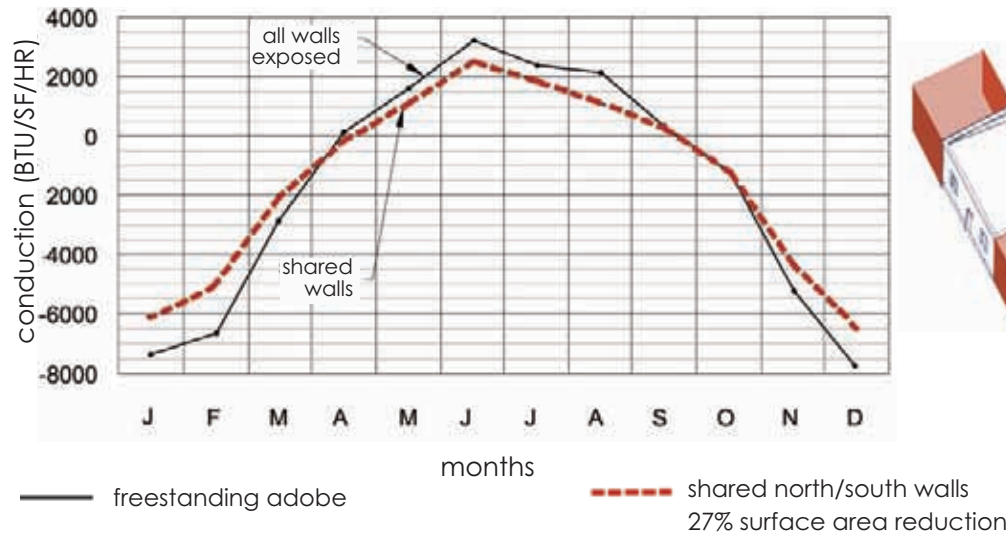

### EFFECT OF SHARED WALLS

■ *investigation summary:* Analyze the impact of shared walls on the thermal efficiency as measured by energy conduction (heat gains and losses in  $Btu/ft^2 \cdot ^\circ F$ ) of an urban adobe, the Stevens House. This house is the only urban adobe in the study that features shared walls on both the north and south faces.

■ *investigation results:* The graph demonstrates that by sharing walls (in this case 27 percent of wall area shared with adjacent buildings), conduction losses in winter and gains in summer are significantly reduced. This means that as exterior conditions become extreme in both summer and winter, the interior is less affected. If a SEER 12 heat pump for both mechanical heating and cooling were conditioning the Stevens House, the graph represents 12 percent annual energy and financial savings.

## EFFECT OF THERMAL MASS

■ *investigation summary:* Analyze extent of heat tempering effect in both high and low mass structures as a function of the difference between monthly high and low interior temperatures. This difference is represented by the diagonally hatched areas in the following graphs.

■ *investigation results:* The Fish House is the *high mass* urban adobe used for comparison to the *low mass* manufactured house base case. Graphs for the low mass case are at right and the high mass cases are on the next page. The graphs dramatically show that the difference between predicted average monthly high and low temperatures is much larger for the manufactured base case both with and without natural ventilation. In the Fish House case, monthly high and low temperatures fluctuate consistently about 5°F as opposed to the typical 20-40°F fluctuation with the base case directly proving the heat tempering effect of high mass house. In the high mass adobe case, lows are in the mid-50s°F and highs in the low-90s°F in great contrast to the low mass base case where temperatures range from the low-40s°F to highs in the mid-110s or so. Additional proof of the high mass adobe house's greater thermal heat capacity is evidenced in the similarity of results whether ventilated or unventilated unlike the low mass case. While the high mass case reaches an interior high of 92°F when unventilated, the low mass case will reach an interior high of 117°F. An enclosure overheating to this extent would be dangerous to occupy. With the high mass house, the heat is being stored in the walls and not in the occupants (to their extreme discomfort).

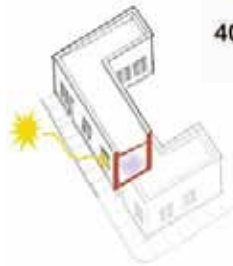

## MONTHLY HIGH AND LOW TEMPERATURES

Base Case-Wood Frame House Interior, natural ventilation

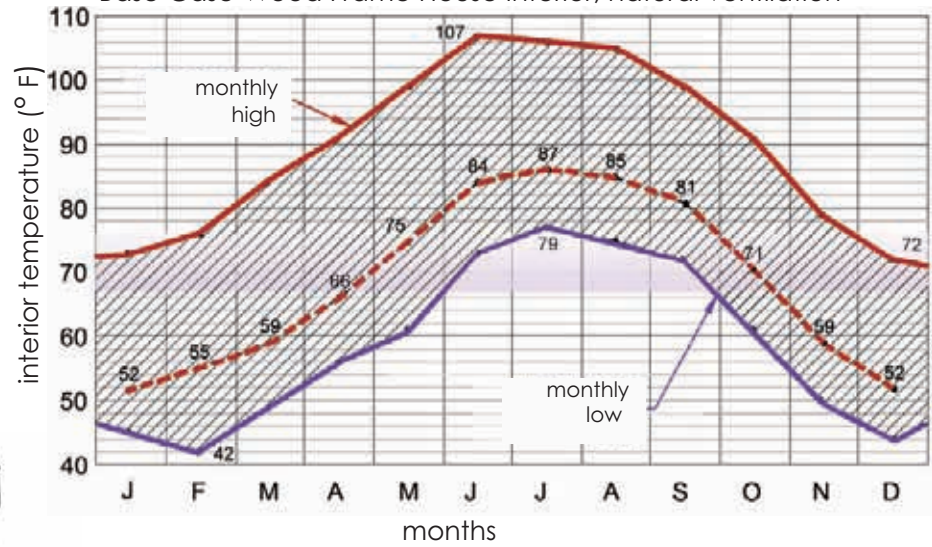

hot  
comfort  
cold

## MONTHLY HIGH AND LOW TEMPERATURES

Base Case-Wood Frame House Interior, no ventilation

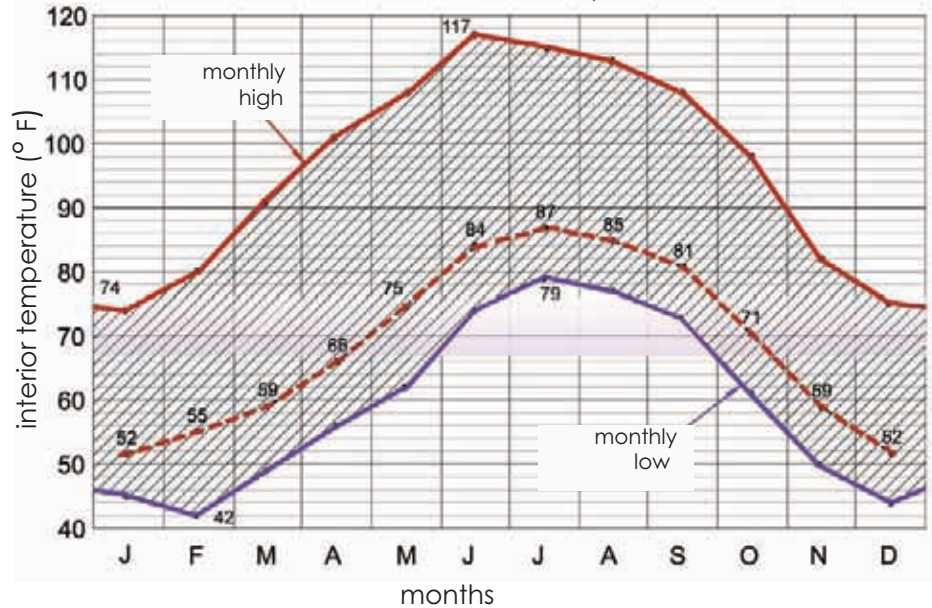

hot  
comfort  
cold

## MONTHLY HIGH AND LOW TEMPERATURES

Fish House: Adobe U-shaped Courtyard Interior, natural ventilation

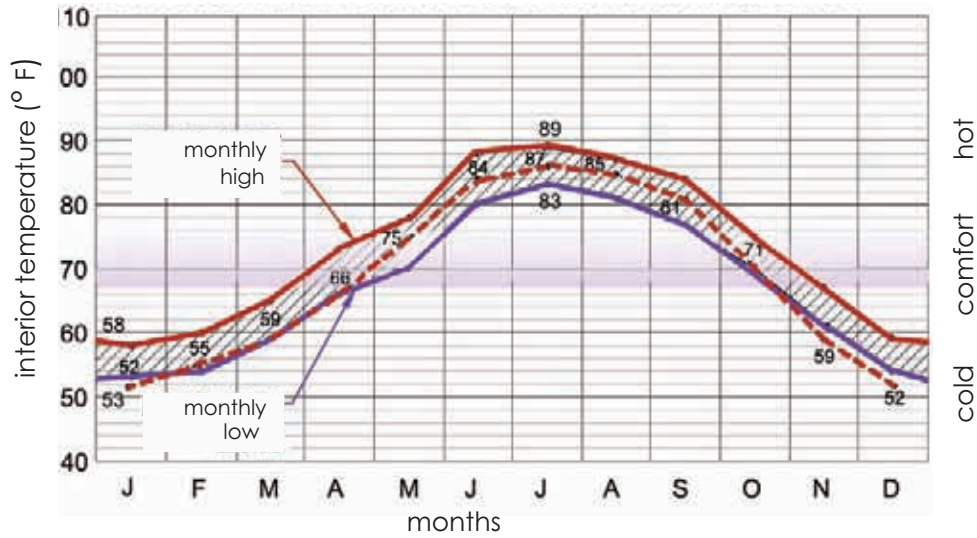

--- NOAA average monthly dry bulb temperature, Tucson AZ

## MONTHLY HIGH AND LOW TEMPERATURES

Fish House: Adobe U-shaped Courtyard Interior, no ventilation

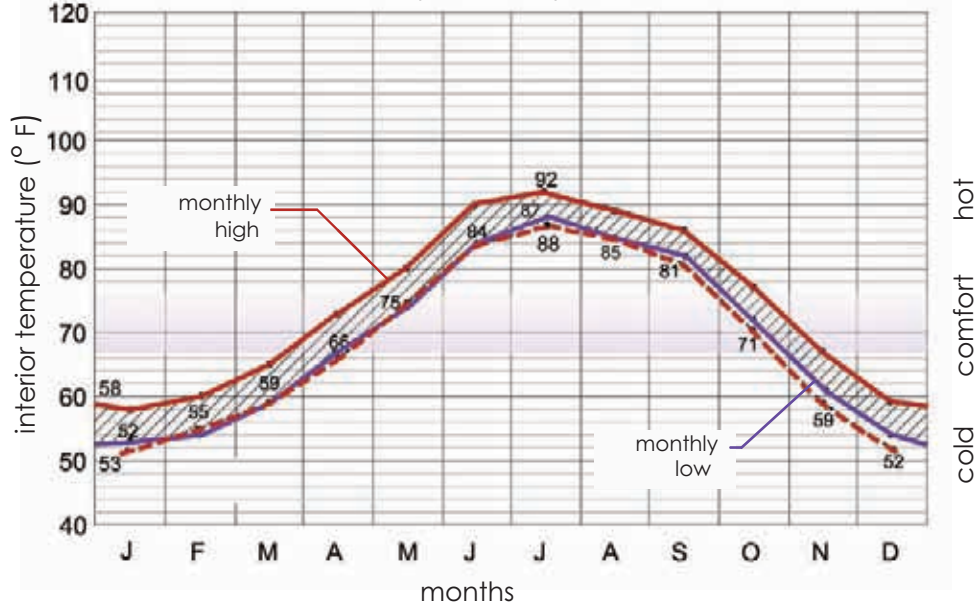

Adobe's ability to regulate mean interior temperature has a direct impact on thermal comfort. The body often feels thermal discomfort in the midst of temperature change but then has the ability to adapt and acclimate, even in temperatures as low as 60°F and as high as 87°F in arid conditions. While the adobe enclosure may be out of perfect thermal comfort range for a good portion of time (68-76°F), the lack of internal temperature fluctuation helps the body to function with less stress. Thermal mass walls also draw excess heat from the skin surface during warm periods and radiate stored heat to the skin surface in cool periods and which more gently conditions the body. When the range of thermal comfort can be increased, less mechanical intervention is needed thus saving in energy costs.

In all, the base case is being more readily affected by the extremes of the diurnal cycle as illustrated additionally by the graphs on the next page.

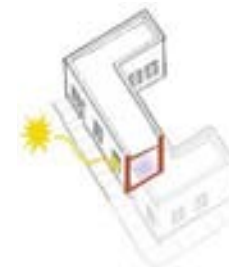

## EFFECT OF DIURNAL SWING

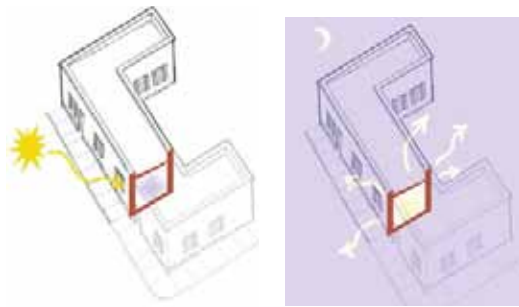

■ *investigation summary:* As a continuation of the previous investigation, analyze extent of tempering effect of thermal mass in comparison to the 2x4 wood frame base case. In this investigation, the fluctuation of interior temperature is analyzed over one diurnal cycle in summer and winter.

■ *investigation results:* The thermal tempering effect of the high thermal mass adobe Fish house is again evident here when demonstrated on a diurnal basis. The mean interior temperature of the low mass base case fluctuates an average of 40°F in winter and 37°F in summer while the adobe fluctuates 7°F in winter and 8°F in summer. The results for the adobe Fish House indicate that the tempering effect of the thermal mass may be more effective in passive cooling than in passive heating if the interior adobe walls are not receiving sufficient solar gains in winter.

Evidenced by these graphs as well is the 2-6 hour delay in peak interior temperatures created by the high mass adobe house as opposed to the low mass manufactured house which is more directly responding to outdoor temperature fluctuations.

## HOURLY MEAN INTERIOR TEMPERATURES

Base Case Interior (low mass) vs. Fish House (high mass): December 11

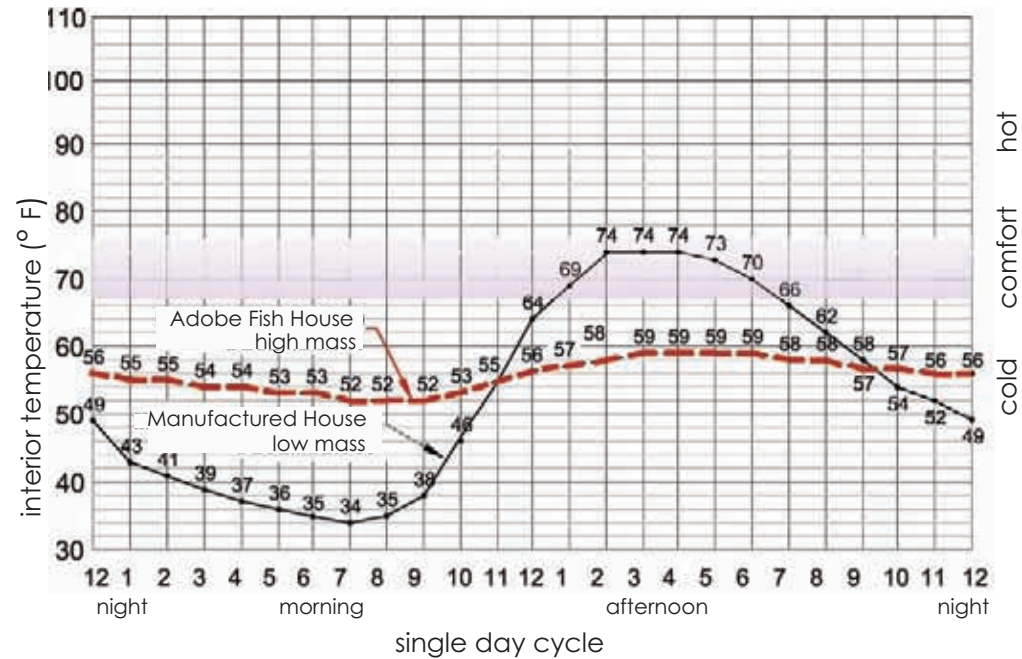

## HOURLY MEAN INTERIOR TEMPERATURES

Base Case (low mass) vs. Fish House (high mass): June 15

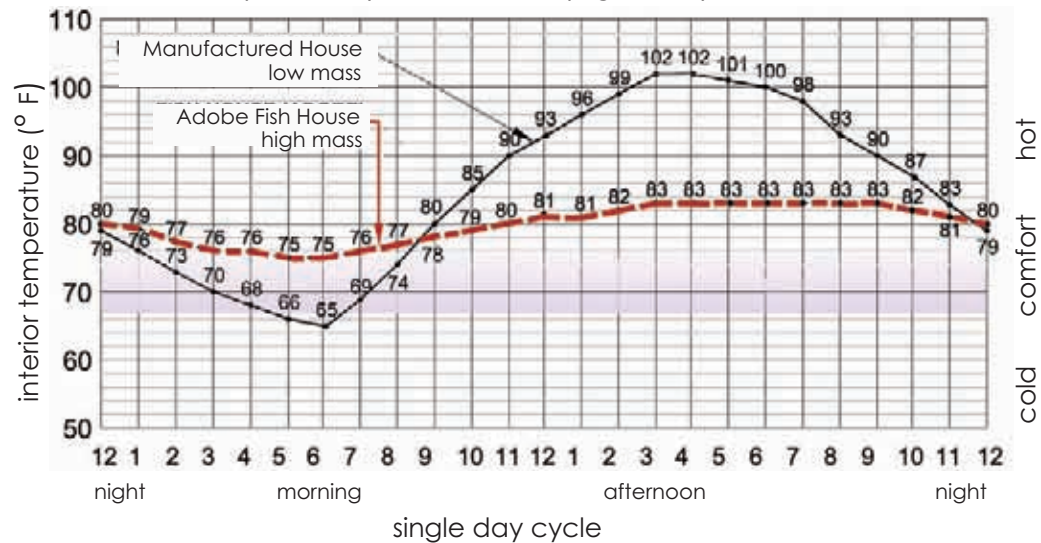



## NATURAL VENTILATION

Base Case (low mass) vs. Fish House (high mass): (10% inlet & outlet)

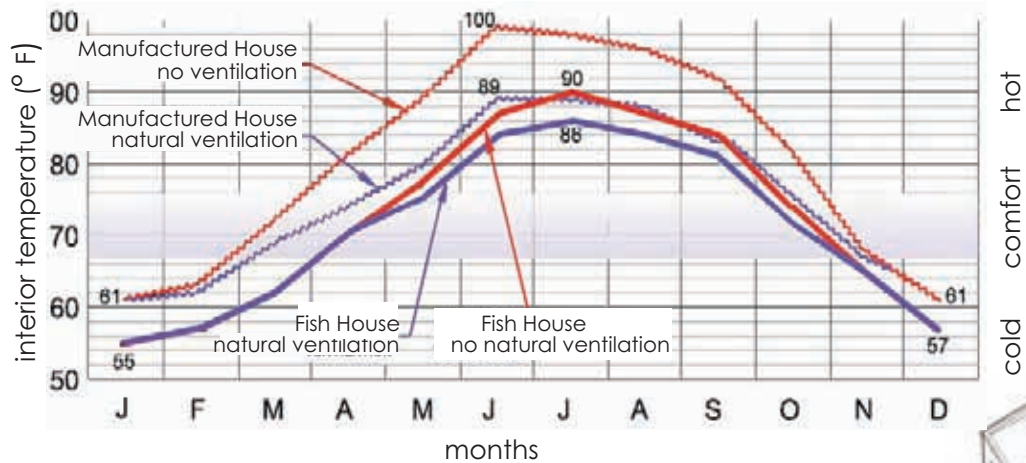

hot  
comfort  
cold



## URBAN COURTYARD

Fish House: U-shaped adobe with East facing courtyard

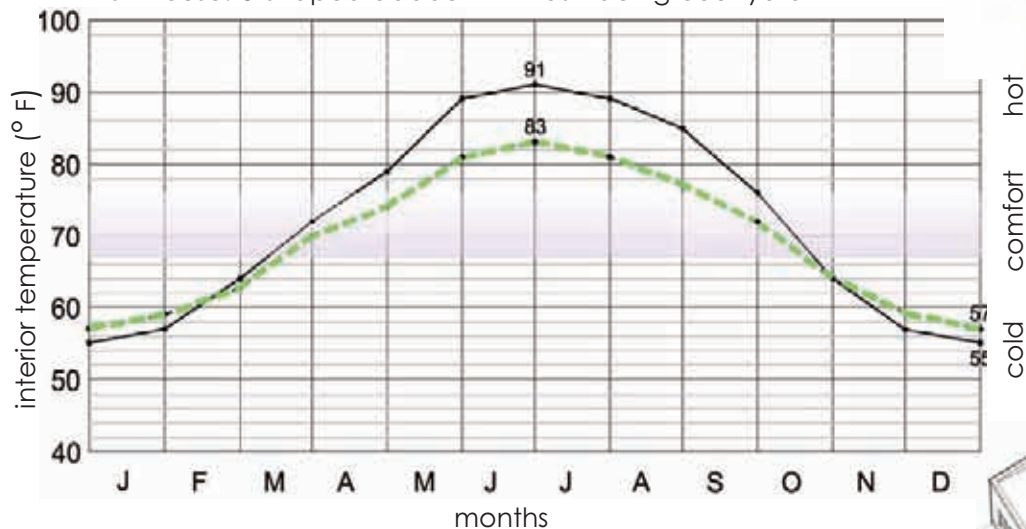

hot  
comfort  
cold



no shade/vegetation in courtyard, existing window area  
shaded/ ventilated courtyard

area of four windows opening into east courtyard increased 4x and modeled to be heavily shaded in warm months.

SG Factors: Nov.-Feb-1.0, Mar.-Apr. 0.4, May-Sept. -.1, Oct, 0.4

## EFFECT OF NATURAL VENTILATION

■ *investigation summary:* Analyze the effectiveness of natural ventilation (10 percent inlet, 10 percent outlet area vs. no natural ventilation) as a function of mean interior temperature for both the adobe Fish House and the manufactured house base case.

■ *investigation results:* The results indicate that natural ventilation is a necessary and effective technique in passive conditioning, particularly in passive cooling. The peak mean interior temperature of the Fish House would be intolerable at 90°F but natural ventilation drops it to a peak of 86°F, at the very upper limit of thermal tolerance in this climate. Interestingly, the manufactured house rises to 102°F interior without natural ventilation which is 12°F above the predicted peak for the Fish House, further proving adobe's heat tempering capability.

### the urban courtyard

■ *investigation summary:* Analyze the effect of the vegetated courtyard of the U-shaped adobe, the Fish House, as a function of mean monthly interior temperature.

■ *investigation results:* The mean interior temperature of the U-shaped adobe is predicted to stay 6-8°F cooler in summer when a vegetated courtyard is combined with significant area of opening facing the shaded courtyard. The courtyard is predicted to be an asset in passive heating as well due to added east glazed area combined with deciduous vegetation which thins to allow more solar gain in winter.



The Fish House Courtyard. Photo: C. Neumann

## WINDOW TYPE, SIZE, DEPTH

- *investigation summary:* Analyze the effect of natural ventilation via inlet/outlet area as a function of mean maximum temperature of the urban adobe, the Stevens House.
- *investigation results:* Improved performance in both passive heating and cooling is most significant with the awning and casement windows which both lowered maximum temperatures by 5°F and increased minimum temperatures by 4°F. This investigation proves that natural ventilation is absolutely necessary to utilizing the thermal mass of adobe for passive conditioning. Opening area must be in proper proportion to the amount of mass and modeling programs, such as CalPas can help to determine the correct balance as every building is unique in terms of form, site, and extent of passive conditioning. The significant depth of the mass, in this case 22", provides additional shading for the glazing as compared to the base case. The glazing of the manufactured house is inset 1-1/2" while the glazing for the adobe is inset 18". The thicker adobe wall provides much more depth for essential shade to the glazing in summer.

## OPERABLE SHUTTERS

The louvered shutters on the Fish Stevens Duffield House are essential in passive cooling. Tests with the Fish House predict a 1-2°F interior mean temperature drop with the use of shutters from March until September.

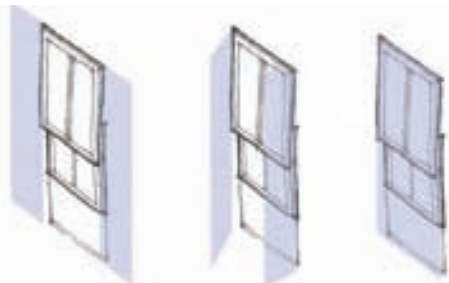

WINTER: SHUTTERS OPEN 80% OF TIME    SPRING/FALL: OPEN 50% OF TIME    SUMMER: SHUTTERS OPEN 20% OF TIME

## INLET AND OUTLET AREAS

Stevens House: natural ventilation and mean max temperature

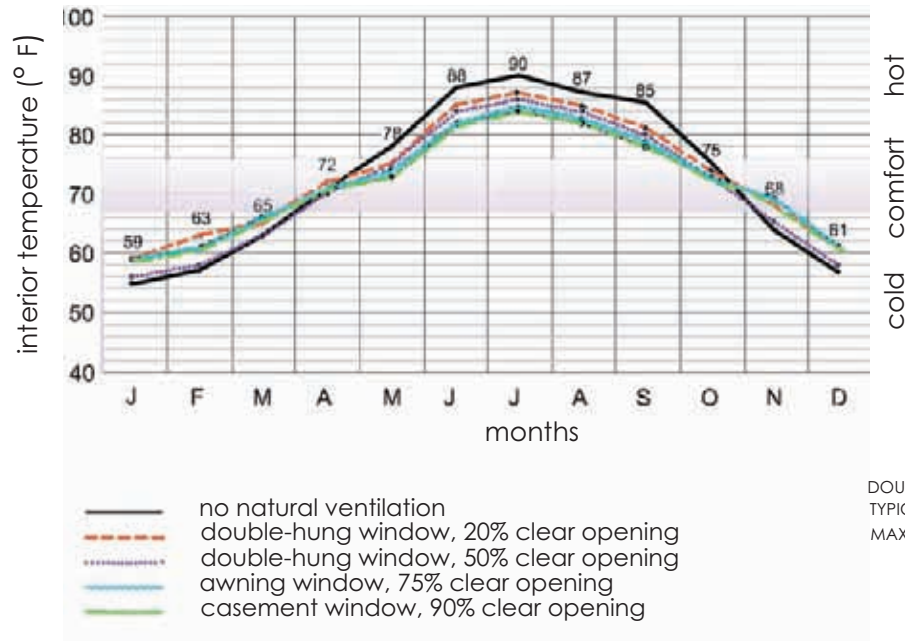

DOUBLE HUNG WINDOW  
TYPICAL OPENING AREA: 10%  
MAX. OPENING AREA: 45%

## INLET AND OUTLET AREA MAXIMIZATION

Fish House vs. Stevens House

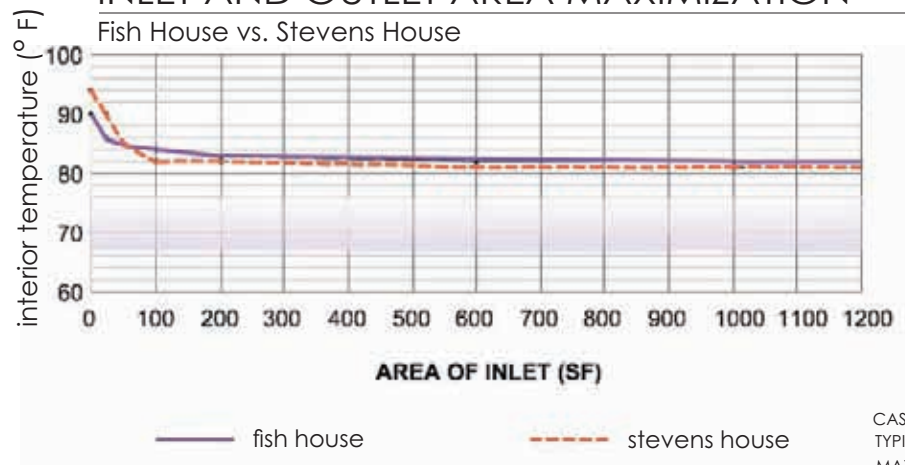

CASEMENT WINDOW  
TYPICAL OPENING AREA: 10%  
MAX. OPENING AREA: 90%

## ANALYSIS #2

### rural adobe house

The Upshaw House on the Gray Ranch in Animas, NM, is the rural example to be compared with the base case manufactured home. The Upshaw House is located at an elevation of 5,000 ft. in the desert grasslands of southern New Mexico. The complex consists of a freestanding adobe home with several small storage buildings, all clustered by shrubs and trees. The closest residence to this complex is five miles away in the Coronado National Forest. The average temperature of this area is approximately 5°F below the urban climate of Tucson and heating is more of a concern than cooling. Rural climates typically have these features:

- *Vegetation:* The habitat of many rural locations in the US/Mexico border region is considered a semi-desert grassland, an arid form of the Great Plains grassland. Air temperatures drop as much as 10-14°F over grasses unlike the urban scenario where surface temperatures of black asphalt can be as much 25°F above ambient air temperatures (Moore, 59).
- *Wind speed:* The lack of large obstructions except perhaps trees means that wind speeds are a bit higher. In the case of this study, rural wind speeds are double that of urban being set at 15 m.p.h.
- *Elevation:* At an elevation of 5000 ft above sea level, the Upshaw House is twice as high as the urban examples. Due to adiabatic lapse rate, this rural site is naturally cooler.

## TEMPERATURE

NOAA 30 Year Monthly Averages, Sierra Vista, AZ

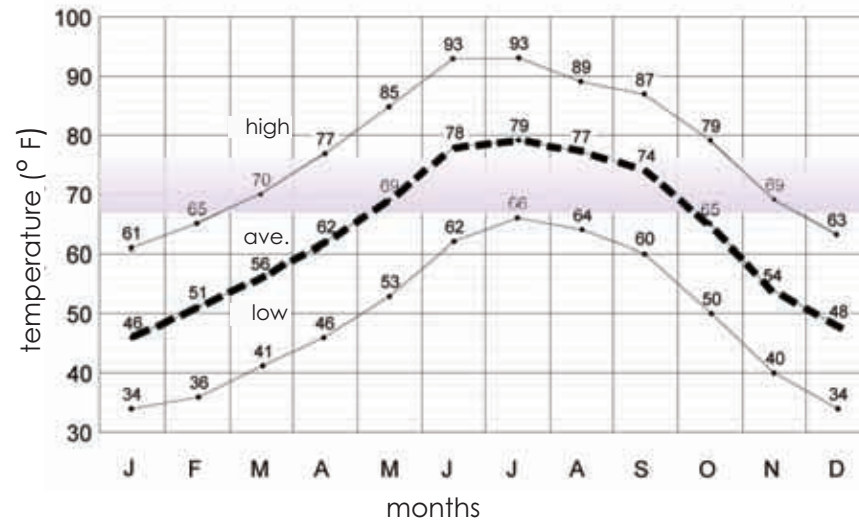

*\*Since no specific weather data was available for the actual site in Animas, NM, the information for Sierra Vista, AZ was substituted as it represents a very similar set of climatic and vegetative conditions*

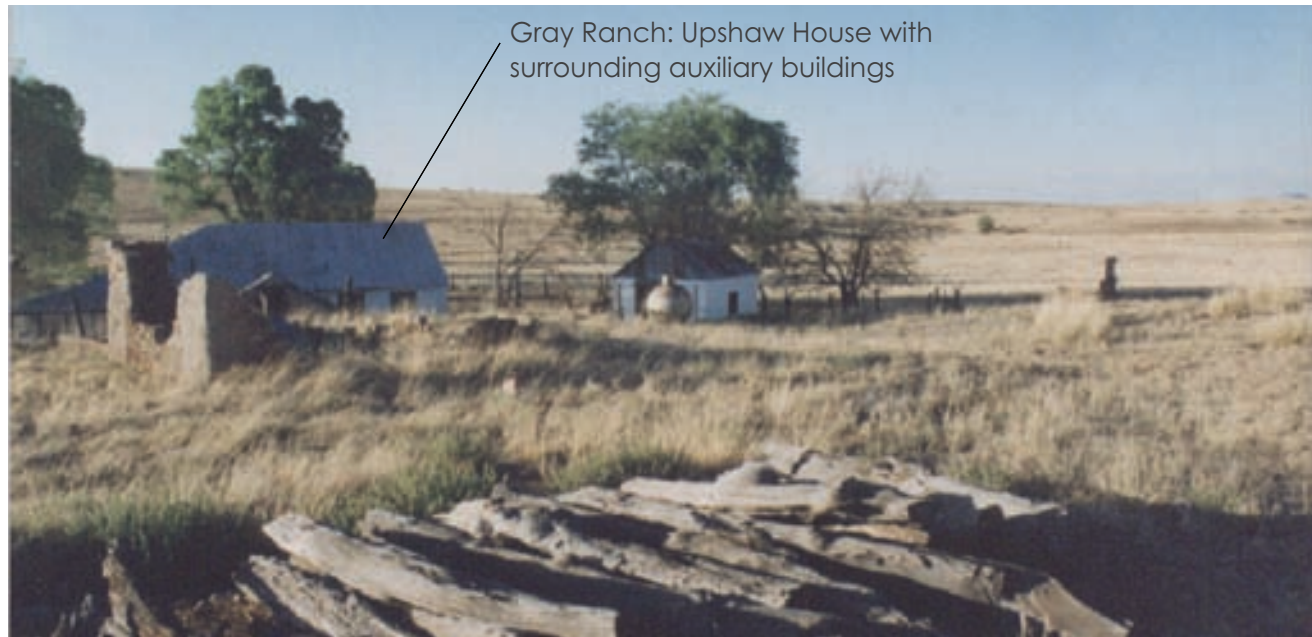

Gray Ranch: Upshaw House with surrounding auxiliary buildings

*View of Upshaw complex showing cluster of buildings surrounded by local vegetation. Photo: B.Vint*

## TRADITIONAL RURAL FORMS

The three cases below represent adaptations that the Upshaw House has undergone over its 80 year history since the 1920s. More information on this house can be found in the Gray Ranch feature of *Ch. 2: Design*. Phase 1 is a simple 630 s.f. rectangular structure built with 12" adobe walls and a hipped metal roof. The interior walls are 12" adobe as well. Phase 2 represents the addition of an 8' deep wood frame porch on the south and west sides of the house. This unconditioned porch is screened so it amply ventilates. Phase 3 is created when a 540 s.f. 8" concrete block addition is attached to the east side and a new metal roof was added. This is the present configuration of the house. The resulting area is almost double Phase 1 being 1170 s.f. All partition walls are frame in this addition and windows are single-pane double hung. The section on the next page shows in detail the material composition.



Upshaw House-Phase 1:

*simple square plan adobe*

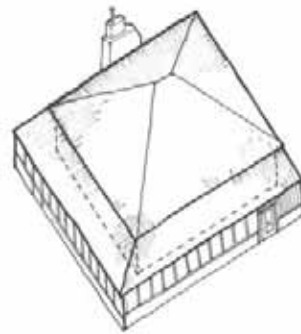

Upshaw House-Phase 2:

*simple square plan adobe with porch*

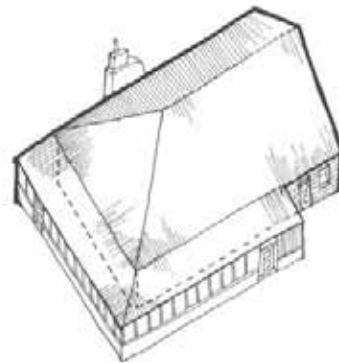

Upshaw House-Phase 3:

*square plan w/ porch and block addition*

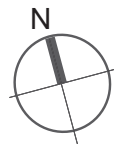

*\*For scaled house plans and additional supplemental information, such as area and volume, see Appendix.*

# CONDUCTIVITY AND HEAT RESISTANCE



*Upshaw Phase 1 Section*



*Upshaw Phase 2 (with porch) Section*



*Upshaw Phase 3 (block addition) Section*

## U ROOF- METAL ROOFING ABOVE ROCK WOOL INSULATION

|                         | BTWN RAFTER (90%) | @ RAFTER (10%) |
|-------------------------|-------------------|----------------|
| OUTSIDE SURFACE         | 0.17              | 0.17           |
| GALV. COR. MTL ROOFING  | ---               | ---            |
| 3/4" PLYWOOD SHEATHING  | 0.93              | 0.93           |
| ROUGH SAWN 2x6 RAFTER   | --                | 6.11           |
| 3" ROCK WOOL INSULATION | 7.08              | 7.08           |
| 6" TIMBER BEAM          | --                | 6.11           |
| INSIDE SURFACE          | .62               | 0.62           |
| <b>TOTAL R:</b>         | <b>8.34</b>       | <b>21.0</b>    |

AVE R = 10.0 **U = 0.1**

## U WALL- UNINSULATED PLASTERED ADOBE

|                           |             |
|---------------------------|-------------|
| INSIDE SURFACE            | 0.62        |
| 1/2" LIME PLASTER SURFACE | 0.15        |
| 12" UNSTABILIZED ADOBE    | ---         |
| 1/2" LIME PLASTER SURFACE | 0.15        |
| OUTSIDE SURFACE           | 0.17        |
| <b>TOTAL R:</b>           | <b>1.09</b> |

AVE R = 1.09 **U = 0.91**

ADOBE SPECIFIED HAS A VOLUMETRIC HEAT CAPACITY OF 25 BTU/CF-F AND CONDUCTIVITY OF 0.30 0 BUTH-FT/SF-F. U-VALUE FOR SINGLE PANE VINYL WINDOW= 0.5 ACCOUNTED FOR IN CALPAS 3 AS SEPARATE ELEMENT FROM ROOF, WALL, OR FLOOR.

## U FLOOR-

4" CONCRETE SLAB FACTORED AS MASS ELEMENT IN CALPAS 3 UNDER THE "SLAB" COMMAND. THE DENSITY OF THE STANDARD CONCRETE SPECIFIED IS 140 LBS/ CF. VOLUMETRIC HEAT CAPACITY IS 28 BTU/CF-F AND CONDUCTIVITY IS 0.980 BTUH-FT/ S.f.-F. NO CARPETING IS APPLIED TO THIS SURFACE.

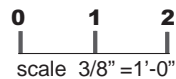
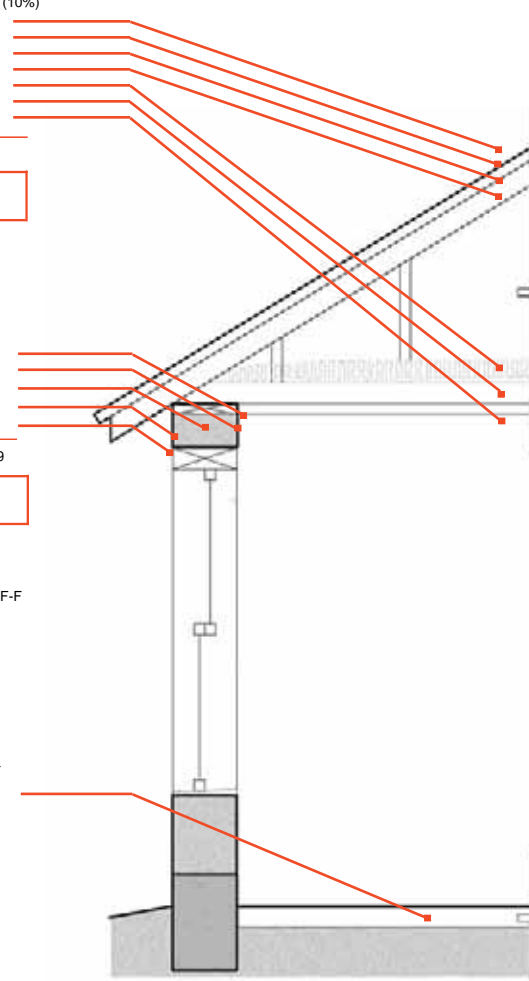

## RURAL ADOBE TYPICAL WALL SECTIONS

## EFFECT OF BUILDING FORM

■ *investigation summary:* Analyze thermal performance as a function of monthly mean interior temperature for manufactured housing base case and three rural adobe cases.

■ *investigation results:* In all cases, the need for passive heating predominates. 60-75 percent of the time, when the houses are predicted to be out of the comfort zone the need is for warmth. Phase 1 performs best in colder conditions, but becomes hottest in summer. The porch of phase 2 drops mean interior temperatures in summer an average of 1-2°F, but becomes a liability in colder months. The porch is too deep to allow solar gain to passively heat the house interior. In all, the historic cases performed better than the manufactured house, keeping temperatures 4-6°F lower in summer and 1-3°F higher in winter. As with the urban examples, the rural adobes are predicted to reach their peak interior temperature a month after the base case further demonstrating their adobe and block wall's ability to delay heat gain. Both adobe and block have a higher thermal heat capacity compared to wood.

## MEAN MONTHLY TEMPERATURE COMPARISON

Upshaw House, Phases 1-3 vs. Manufactured House

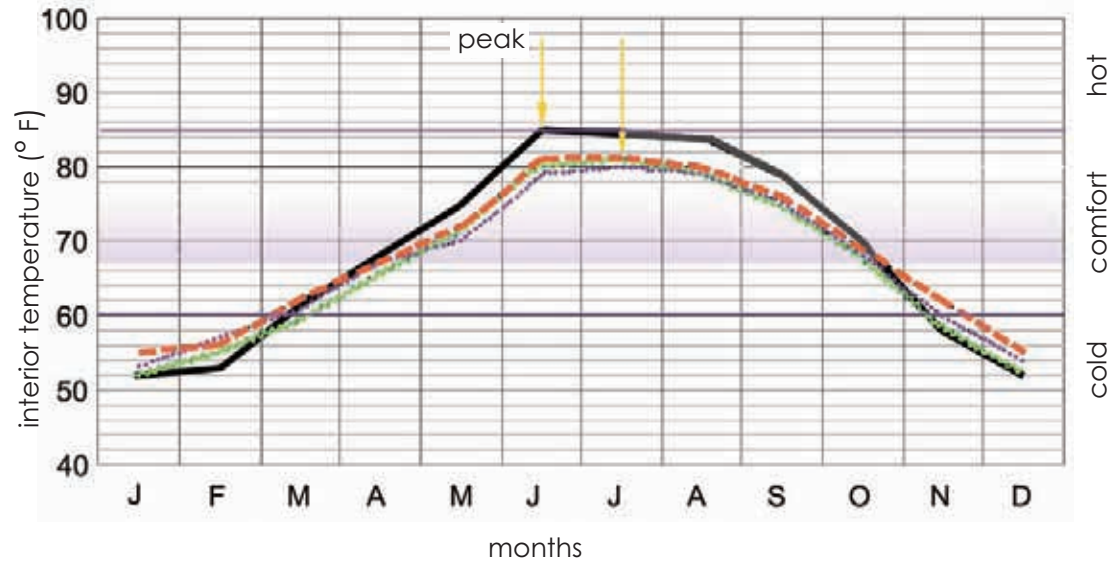

— 1659 s.f. s.v.r.= 17%  
base case  
manufactured house

--- 630 s.f. s.v.r.= 38%  
phase 1

..... 630 s.f. s.v.r.= 38%  
phase 2

~~~~~ 1170 s.f. s.v.r.= 19%  
phase 3

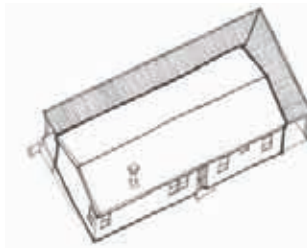

SUMMER HI: 102°F  
WINTER LOW: 37°F  
% YEAR - COMFORT ZONE : 22.5%  
% YEAR - EXTENDED COMFORT ZONE : 66%



SUMMER HI: 89°F  
WINTER LOW: 51°F  
% YEAR - COMFORT ZONE : 33%  
% YEAR - EXTENDED COMFORT ZONE : 75%

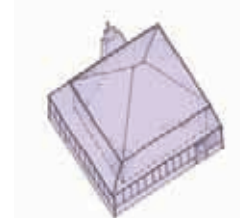

SUMMER HI: 87°F  
WINTER LOW: 49°F  
% YEAR - COMFORT ZONE : 33%  
% YEAR - EXTENDED COMFORT ZONE : 75%

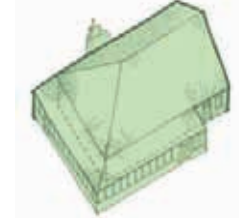

SUMMER HI: 88°F  
WINTER LOW: 47°F  
% YEAR - COMFORT ZONE : 23%  
% YEAR - EXTENDED COMFORT ZONE : 66%

\* s.v.r. = Surface to Volume Ratio, see p. 129

## MONTHLY HIGH AND LOW TEMPERATURES

Upshaw Phase 2 vs. Manufactured house Interior: natural ventilation

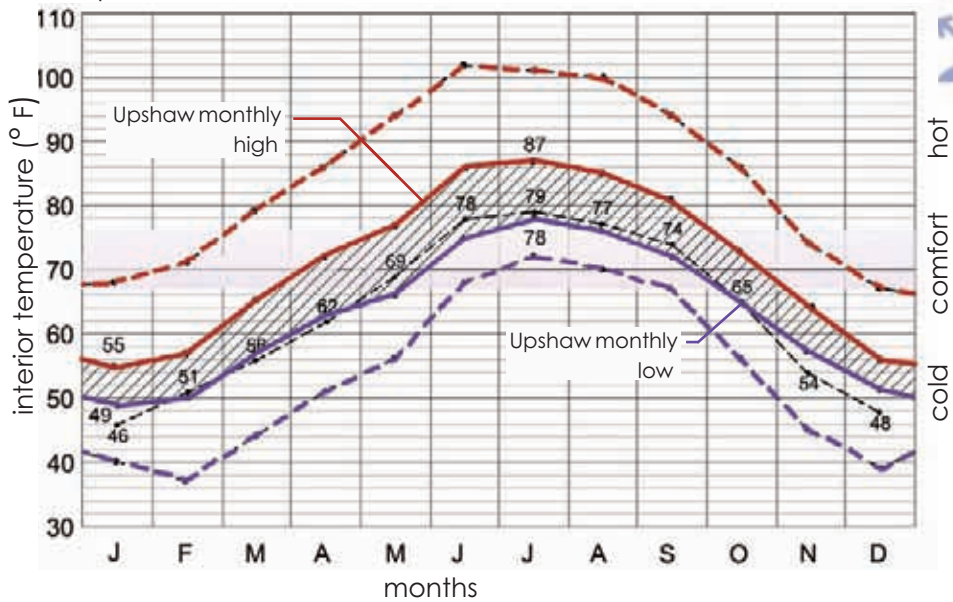

- Manufactured House: monthly high
- Manufactured House: monthly low
- NOAA average monthly dry bulb temperature, Tucson AZ

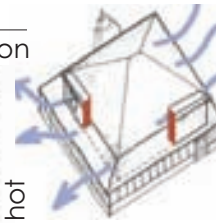

## EFFECT OF THERMAL MASS

■ *investigation summary:* Analyze extent of heat tempering effect in both high and low mass structures as a function of the difference between monthly high and low interior temperatures. This difference is represented by the diagonally hatched areas in the following graphs.

■ *investigation results:* The rural climate, being about 5°F cooler, creates greater concern for tempering both high and low exterior temperatures. The graph at left demonstrates the tempering effect of the high mass adobe Upshaw house and its constant ability to keep temperatures above exterior averages in the winter and at times below the same averages in summer as opposed to the low mass base case. Passive heating performance of the Upshaw house is not as successful since the 8' deep porch on the south and west sides blocks direct solar gain in winter. Additional heating was traditionally supplied by a wood burning stove.

## EFFECT OF WINDBREAKS

■ *investigation summary:* Analyze the effect of wind speed as a function of mean monthly temperature on the Upshaw House, Phase 1.

■ *investigation results:* Reducing local wind speed by strategically placing barriers, such as auxiliary buildings, native trees/ shrubs or even lesser used vehicles can be an asset in passive heating in a rural climate. In this investigation, by reducing local wind speed to half, the Upshaw house is predicted to be much more effective in passive heating for all colder months, from November until April. Interior mean temperatures are predicted to rise an average of 2-4°F. In this colder climate, the reduction in wind speed does not have significant negative impact on passive cooling but a seasonal barrier may be a suggestion if a higher wind speed is desired in summer.



## WINDBREAKS IN RURAL CLIMATES

Upshaw Phase 1

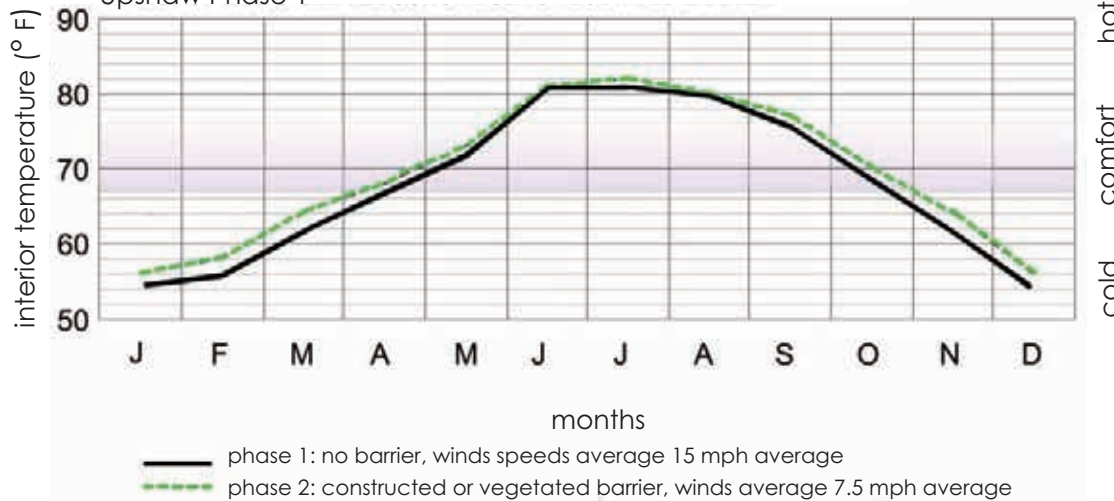

## EFFECT OF UNENCLOSED PORCH

■ *investigation summary:* Analyze the effect of the porch addition in Phase 2 upon thermal performance as a function of monthly mean interior temperature.

■ *investigation results:* The addition of the porch is more effective in passive cooling than in passive heating, as it is predicted to drop each monthly mean temperature by 1-2 °F. Phase 2 will remain in the comfort zone about 1-2 weeks longer as compared to Phase 1. Additional testing was done to investigate porch orientation when the house is rotated in 90 degree increments. The diagrams to the lower right demonstrate this rotation. Both position B and C were more efficient in passive heating without raising temperatures during the summer. Both were predicted to raise the mean monthly temperatures in winter by 1 °F. Another test with position A in which the porch depth was shortened to 4 ft. yielded similar results in summer and winter. In this case, passive heating was more successful since the adobe walls were more directly exposed to solar gains in winter.

## SCREENED PORCH

Upshaw Phase 1 vs. Phase 2

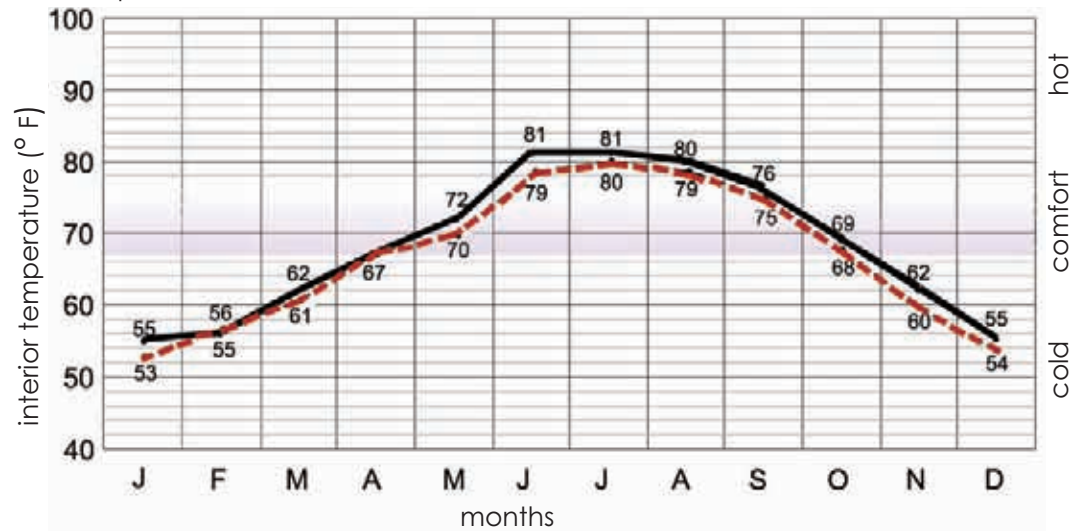

— Upshaw house, phase 1  
 - - - Upshaw house, phase 2



*The deep screened porch of the Upshaw house.  
 Photo: B. Vint*

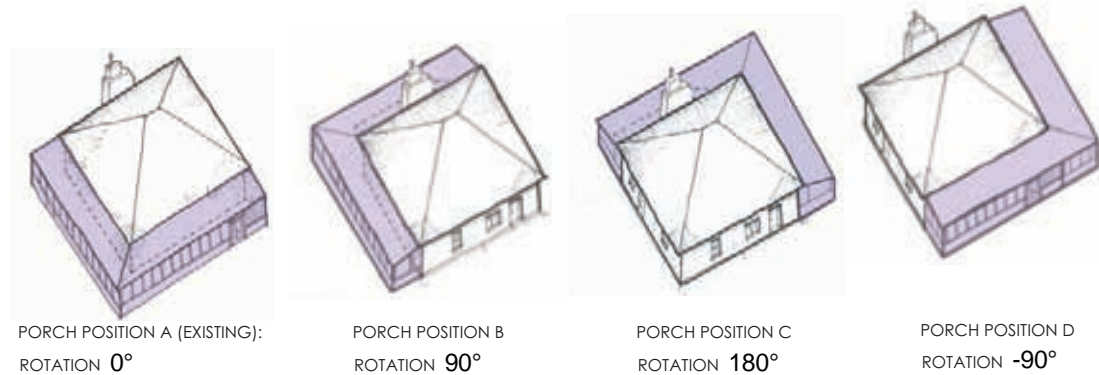



## ANALYSIS HIGHLIGHTS



### Rural Analysis

Upshaw House, Animas, New Mexico

Thermal comfort period elongated 0 - 9 %  
over base case manufactured house

■ *High mass beat tempering* is a viable traditional passive cooling strategy in the arid Southwest.

- Peak mean interior temperatures for all high mass adobe cases are predicted to stay at least 4-6 °F below the low mass base case.
- High, low and mean interior temperatures of both rural and urban adobe cases stayed below the threshold of extended human thermal comfort unlike the base case which was well above this limit for June, July and August. The two psychrometric charts p.150 further demonstrate these results.
- Peak interior temperatures of the adobe homes were predicted to be delayed one full month, from June with the base case to July .

■ *Natural ventilation*, particularly during cooler night hours, is a strategy that is vital for thermal mass cooling and southerly exposed operable glazing with appropriate shade allows passive solar heating in addition to ventilation cooling.

- For the urban adobes analyzed, the introduction of natural ventilation lowered temperatures by 5-8°F. This drop in summer is due to natural cross and stack ventilation and blackbody radiation to the clear night sky.
- The introduction of the casement window, with the most clear opening (90%) of all window types, was most effective in improving ventilation. In the Stevens House, temperatures drop 7°F in summer and rise 4°F in winter.
- Passive solar heating is as essential as cooling in the rural analysis due to higher wind speeds and cooler average exterior temperatures. The porch



### Urban Analysis

Fish Stevens Duffield House, Tucson AZ

Thermal comfort period elongated 21 - 29 %  
over base case manufactured house

of the Upshaw house blocks direct solar gain and prevents the high mass building's ability to store precious solar heat which could be gained in cold periods.

■ *Seasonally vegetated courtyard* is potentially the most effective passive conditioning strategy for both heating and cooling.

- The shallow U-shaped form of the Fish House, with its seasonally vegetated courtyard, was the most successful in passive cooling of all cases tested, as its mean interior temperature peaked at 83°F, staying 2-8°F lower than the other adobes and the base case.
- Summer shading via dense vegetation, significant depth of mass wall ( 18" window inset in urban adobe homes) and louvered shutters, permits a greater area of opening/glazing for enhanced natural ventilation in summer and solar gain in winter. In the case of the Fish House, while a south facing courtyard would be more ideal as opposed to the existing the east orientation, nonetheless, by increasing the area of open/glazing, mean interior temperatures increased by a few degrees in winter.
- Additional passive cooling effects due to evapotranspiration from plants or evaporation from a courtyard fountain were not accounted for in this study, but their common incorporation into traditional courtyards, such as that of the Cordova House, indicates that they also are integral in the creation of a thermally desirable courtyard microclimate. Using native seasonal trees and shrubs adapted to a hot arid climate aids in reduction of water consumption.

## CONCLUSIONS

Indigenous passive conditioning strategies, in particular *thermal mass beat tempering*, *controlled natural ventilation* and *seasonally vegetated courtyards*, are recommended as the basis for home conditioning in the hot arid Southwest. This study demonstrates the effectiveness of these strategies, as evidenced in the superior thermal performance of the two high mass vernacular cases when compared to a standard low mass contemporary manufactured house. The conventional wood stud and vinyl-sided manufactured house analyzed was designed specifically to be dependent on mechanical heating/cooling at all times and thus operates alien to its local climate.

Indigenous strategies for thermal control are effective in creating environments within a *reasonable range of human thermal toleration* which is particularly evident during times of extreme heat and cold. While these native structures don't consistently keep within the perfect bounds of thermal comfort (68-76°F), a feat only achieved by energy-intensive mechanical conditioning, they temper outside temperatures such that life is not threatened. The extremely high interior temperatures (averages in 100s) predicted for the unconditioned base case during the hot months simulate the grim reality of unconditioned housing not adapted to a hot and arid climate. This predicament is not uncommon for low-income people living in substandard housing units who cannot afford high air conditioning bills or conditioning system maintenance.

Further study is required to engineer floor, wall, and roof systems which utilize these passive strategies in conjunction with modern living patterns, construction methods and conditioning. Hybrid wall systems combining high insulation materials (straw bale, rigid insulation, etc.) in conjunction with thermal mass materials such as adobe, Concrete Earth Blocks (CEB) or Concrete Masonry Units (CMU) have potential to be the most energy efficient and regionally appropriate enclosures.

## CONCLUSIONS

The comparison at right again demonstrates the superior thermal performance of the high mass traditional case when compared to the low mass manufactured base case with regard to passive conditioning strategies in a hot arid climate. High and low monthly interior temperatures and their corresponding wet bulb temperatures were plotted on the psychrometric charts. The colors correspond with months of various seasons. They are as follows:

- *summer months*  
June, July, August
- *fall months*  
September, October, November
- *winter months*  
December, January, February
- *spring months*  
March, April, May

A comparison of these charts illustrates that the interior temperatures of the traditional high mass adobe house do not fluctuate as drastically as the low mass house. Temperatures also fall within the comfort zone (the purple region) more frequently with the high mass case. Of greatest interest is that, except in December, the high mass house is not out of range of the extended human comfort zone when passive solar heating and high mass cooling are considered. This extended high mass cooling zone does not apply to the low mass manufactured house. Even if mechanical conditioning were to be analyzed as well, it is apparent that if passive strategies for heating and cooling were applied and optimized before mechanical intervention, the high mass house would consume less energy to maintain comfortable interior temperatures resulting in homeowner cost savings.

From the Acoma Pueblo to the Gray Ranch, the vernacular architecture examples profiled in this book feature many regional building adaptations and energy conservation techniques that are as valid and effective for enclosure conditioning today as they were a thousand years ago.

## PSYCHROMETRIC CHART

low mass wood frame house  
natural ventilation

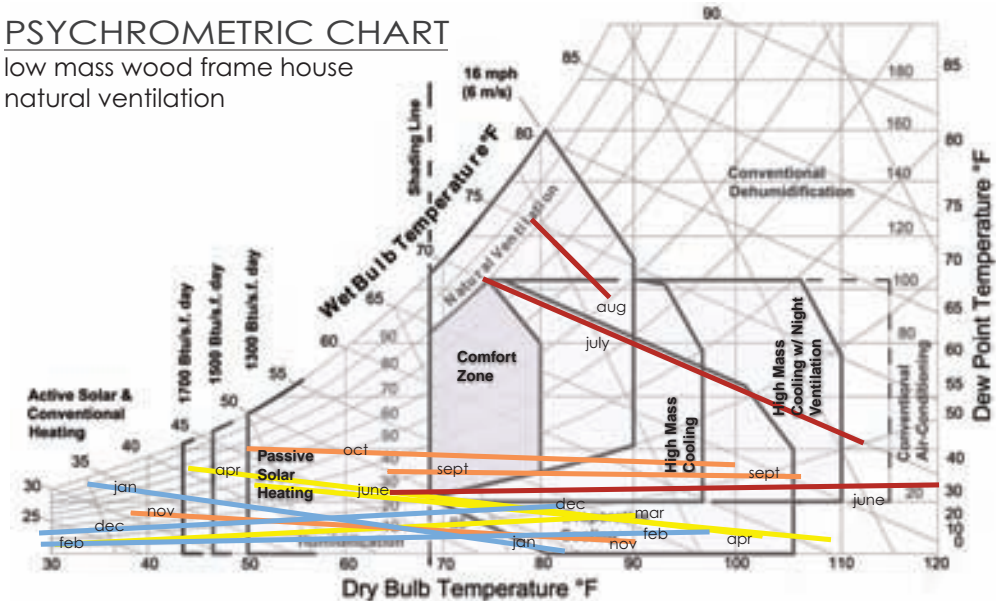

| extreme temperatures °F | jan    | feb    | mar    | apr     | may     | june    | july   | aug     | sept    | oct    | nov    | dec    |
|-------------------------|--------|--------|--------|---------|---------|---------|--------|---------|---------|--------|--------|--------|
| dry bulb low/ day       | 35/ 5  | 27/ 21 | 31/ 22 | 45/ 23  | 51/ 6   | 65/ 16  | 73/ 10 | 72/ 15  | 65/ 28  | 49/ 20 | 38/ 27 | 27/ 29 |
| wet bulb low            | 33     | 19     | 21     | 41      | 43      | 46      | 70     | 70      | 50      | 46     | 32     | 23     |
| dry bulb high/ day      | 82/ 14 | 89/ 7  | 97/ 8  | 103/ 13 | 109/ 10 | 121/ 25 | 116/ 2 | 112/ 30 | 107/ 16 | 100/ 2 | 90/ 11 | 83/ 2  |
| wet bulb high           | 49     | 52     | 53     | 58      | 60      | 68      | 70     | 70      | 65      | 66     | 53     | 54     |

## PSYCHROMETRIC CHART

high mass adobe Fish House  
natural ventilation

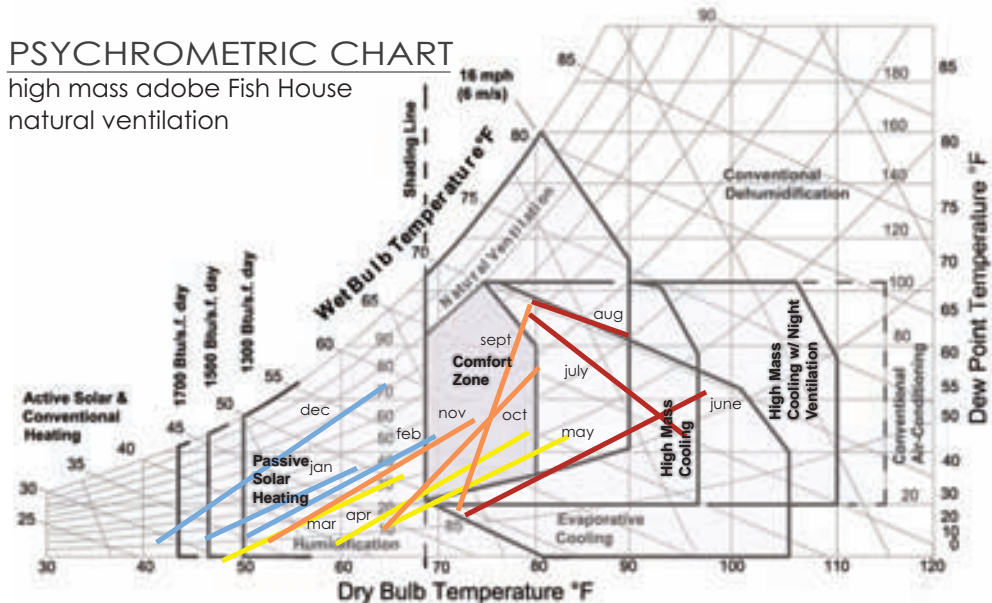

| extreme temperatures °F | jan    | feb    | mar    | apr    | may    | june   | july   | aug   | sept   | oct    | nov    | dec    |
|-------------------------|--------|--------|--------|--------|--------|--------|--------|-------|--------|--------|--------|--------|
| dry bulb low/ day       | 47/ 6  | 47/ 25 | 51/ 1  | 60/ 3  | 65/ 6  | 74/ 16 | 79/ 24 | 78/ 1 | 73/ 28 | 64/ 20 | 54/ 28 | 42/ 31 |
| wet bulb low            | 32     | 30     | 36     | 39     | 43     | 49     | 68     | 68    | 48     | 46     | 31     | 29     |
| dry bulb high/ day      | 62/ 24 | 67/ 8  | 70/ 10 | 79/ 14 | 84/ 12 | 97/ 21 | 96/ 5  | 90/ 7 | 89/ 1  | 81/ 2  | 76/ 1  | 67/ 7  |
| wet bulb high           | 50     | 51     | 57     | 56     | 62     | 68     | 66     | 73    | 70     | 66     | 58     | 59     |

# PROTOTYPES

## applying the lessons of tradition

Traditional housing holds many lessons for today's designers and builders in the creation of humane and environmentally appropriate environments. Following are prototypical house designs and neighborhood arrangements based on traditional principles. The prototypes are compared to a typical "starter-home" as one might find in a Southwestern subdivision of mass-produced houses, representing today's conventional method of production.

The prototypes have compact plan forms with the goal of building affordably and efficiently. While a contemporary trend in new housing development is towards building larger houses more cheaply, an alternative thesis is to build smaller and more efficient houses from higher-quality materials with greater energy efficiency. To do so affordably will require an emphasis on efficient house design and neighborhood planning.

Each prototype is presented first as an individual floor plan, then in a typical cluster or block plan, and finally expanded to the scale of a neighborhood. The neighborhood plans are presented to illustrate the types of densities and arrangements that are possible with the house types considered. Thought is given to the creation of common public space for each neighborhood. This might be a park with a playground, a recreation center, or a school. In the planning of new neighborhoods with a large enough population to support commercial development, coordination among developers, builders and municipalities can create a plan that includes a market, café or business center in the form of a small town plaza. These common elements serve as both literal and symbolic centers to a neighborhood.

Design of these public elements, and related concerns, such as traffic planning, is beyond the scope of this study. The neighborhood plans are therefore diagrammatic, serving to illustrate the principles of density, courtyards, and the creation of private and public space. This preliminary exercise in town planning is not intended to be followed literally. In an actual development a variety of house types should be designed that work together to create block patterns with a built-in variety of floor plans and sizes. By working with common modules, a range of 2, 3 and 4 bedroom plans can be developed

## EFFICIENCY

The prototypical housing designs which follow include:

- Detached single-family house plan based on the Anglo ranch house and bungalow traditions.
- Attached L-shaped and U-shaped courtyard house plans based on the Hispanic tradition.
- Attached 2-story row-house with terraces based on the Native American pueblo tradition.

The prototypes were designed with 16 inch thick exterior walls to permit the use of any of the three alternative materials discussed here: adobe, rammed earth or straw bale. The interior spaces are based on the same program as the Base Case suburban house with regard to the functions accommodated and the sizes of rooms. In comparing the gross floor areas of the conventional Base Case with the prototypes, it must be remembered that the prototypes are based on thick-walled systems, while the Base Case has six inch thick wood frame exterior walls. Therefore, the gross floor area of the prototypes is greater than that of the conventional house.

Efficiency concerns not only the design of individual houses, but more significantly the urban form or land use pattern employed in developments. Compact house forms with a minimum of exterior walls are both less expensive to build and to operate. The free-standing rectangular box, typical of subdivisions, minimizes exterior wall area by its centralized shape, yet it is exposed on all sides because it doesn't share walls with its neighbors. If the detached housing model is followed, large land areas are necessary along with extensions of roads and utilities. Land and infrastructure costs must be factored in to the overall cost of the development.

Significantly higher densities can be achieved by joining dwelling units and sharing walls. This reduces both the initial construction cost and the land cost attributable to each unit, as well as the cost of supporting infrastructure. Savings can be dramatic for a medium to large-scale development.

In evaluating the prototypes, interior floor area is expressed as a ratio of exterior surface area of the walls and roof. A greater ratio result indicates a more efficient enclosure system. For example, the efficiency ratio of the detached single-family (Base Case) house equals .46, while the efficiency ratio of the two-story row house (Urban Prototype 3) is approximately *four times greater*, equalling 1.88.

Shared walls between attached units are not counted in the calculation, as they are not exposed to the elements and do not contribute to heat loss and gain.

## AFFORDABILITY

The alternative prototypes proposed have two basic problems in regard to costs: (1) they are larger than the standard minimum tract house, and (2) they are designed of more expensive materials. To be feasible for affordable housing the prototypes must be more efficient in their overall design, construction and land use. With additional planning, costs can be reduced.

For traditional materials, such as adobe or rammed earth, to be economically feasible for use in affordable housing, walls must be shared. These high-thermal mass materials are twice the cost of conventional frame walls, and so must be "built once and used twice" that is, shared by two dwellings to be affordable. There are further climatic advantages to sharing walls, as this reduces the amount of exterior wall area subject to heat loss or gain.

As seen consistently in traditional housing, affordability favors simplicity. The floor plans resolve into rectangles and squares. Rooms are arranged in simple volumes and alignments, and often connect directly one to the other without hallways. This directness and simplicity may seem startling, but is the result of the designers and builders using the most direct and economical means.

Sure ways to reduce construction costs include reducing the size of houses, and sharing functions within a single space. A combined living/dining/kitchen area is a more efficient use of space than creating separate rooms. All of the prototypes may be further reduced in cost by reducing the size

## COURTYARDS AND DENSITY

or number of rooms. For example bedrooms may be reduced by up to 20 percent in area by reducing them from a standard 12 ft. by 11 ft. size to an 11 ft. by 10 ft. dimension. Houses can function adequately with one bathroom, rather than two as is now commonly expected. Dividing bathroom plumbing fixtures so that a toilet and sink are together in one space, and a tub/shower and a second sink are in an separate space, allows the family the effective use of two bathrooms, while not incurring the cost of two full bathrooms.

To reduce the life-cycle costs of maintenance, the use of durable materials, such as adobe or rammed earth, is encouraged. Using traditional passive heating, cooling and ventilation methods as explored in this report will reduce utility bills, as the house can stay comfortable for more of the year without needing to run the mechanical system. The initial cost of building a traditionally planned house using traditional southwestern materials is higher than using conventional planning and materials. Yet the home owner can learn the value of owning a more efficiently designed house, built of environmentally responsible materials, that costs less to own and operate over its lifespan.

In considering these alternatives, the concept of building smaller houses of higher quality design and materials is valid with regard to advancing the use of adobe or other alternative construction materials in the Southwest border region.

To maintain privacy for individual dwellings while achieving higher density development, use of the courtyard type of housing is very important. Courtyard and patio homes are also climatically and culturally appropriate for many low-moderate income families in the U.S. Southwest. Courtyards provide the oasis in the desert at the heart of each dwelling, as witnessed in the numerous traditional examples surveyed.

The greater efficiency of the high-density/low-rise design approach can off-set the higher cost of building with adobe, rammed earth or straw bale. Although the construction cost of an adobe courtyard house is higher than that of a standard detached wood frame house, the overall project cost may be equalized once the costs of land and infrastructure are taken into account. Courtyard housing appears to be a feasible alternative for a number of reasons.

### *Cultural and social factors:*

- Courtyard houses reflect a centuries-old Latin tradition.
- The courtyard at the heart of the house is essentially a large out-door room, a private place for outdoor living.
- Neighborhoods of courtyard houses are pedestrian-friendly, a positive social environment with greater opportunities for social interaction.
- Greater population density creates defensible space, reducing crime.

### *Environmental factors:*

- Courtyards have passive cooling and heating advantages, creating an oasis/micro climate for the summer and allowing sun in the winter.
- Shared walls reduce exterior surface and reduce heat loss & gain.
- Greater efficiency of land use reduces infrastructure costs, preserves wildlife.

### *Economic factors:*

- Higher densities possible with courtyard planning reduce land and infrastructure costs.
- Shared walls between courtyard houses can make use of adobe or rammed earth possible.
- Compact houses with courtyards use less energy and cost less to own and operate than detached suburban houses.
- The courtyard provides the largest room in the house: views into the courtyard make the interior feel more spacious, allowing smaller-sized rooms to be used.

Following are prototypical house designs presented in order of increasing density. Preliminary cost estimates are based on regional per-square-foot costs for single-story houses with nine foot ceilings, wood or metal truss roofs, exposed concrete floors, and economy-standard, finishes, fixtures and hardware, as of summer 2004.

## COST ESTIMATES

*“The stereotype of the conventional individual dwelling is that of a box sitting on a lot surrounded by space. The box has no privacy as the windows are outward looking, and the surrounding [yard] is [also] not private.”*

Peter Land,

*Economic Housing: High Density, Low Rise, Expandable*

The comparative cost estimates which follow, for the Base Case and the four alternative prototypes, are based on approximate land and construction costs in southern Arizona, current as of the fall of 2004. Because costs vary with both market conditions and geographic areas, these estimates serve only to illustrate in relative terms the range of probable costs incurred by varying housing types and land uses.

Construction costs are estimated on a per-square-foot basis, which serves to set the cost within a range, plus or minus ten percent. For purposes of these estimates, construction is as illustrated in the prototypical wall sections presented in Ch.3. Many design decisions which affect building costs have to do with finishes (such as floors, walls, ceilings, roofing etc.). These estimates assume that floors are exposed colored concrete. Straw bale walls are plastered inside and out. Stabilized adobe walls are left exposed (i.e. unplastered) inside and out. Interior partitions and ceilings are finished with gypsum board and painted. Such elements as doors, windows, and cabinets are assumed to be of moderate

production quality, meeting minimum property standards, of the sort used in production homes. Roofs are structured with prefabricated wood or metal trusses. Roofing is corrugated galvanized iron sheeting.

The alternative designs with earthen walls are estimated with a per-square foot cost factor that is twelve percent higher than a conventional frame/stucco house. This reflects a rule of thumb that the exterior walls of a house account for roughly one-fifth of the total construction cost. Given that earthen walls cost twice as much to build as conventional frame/stucco walls, we have a 100 percent increase for 20 percent of the project, equaling a twenty percent greater cost for the alternative method of construction. Some of the additional cost can be recovered through sharing walls, but clearly not all walls can be shared. If approximately two fifths of the exterior walls can be shared through courtyard design and attached units, the twenty percent additional cost is reduced to around twelve percent greater overall. As an arithmetic equation, it looks like this:

Estimated cost for incorporating alternative wall systems in housing construction:

for freestanding house:

$$100\% \text{ cost increase of wall} \times 1/5 \text{ wall / house ratio} = (1.0 \times 0.2) = 20\% \text{ greater cost}$$

for attached house:

$$20\% \text{ greater cost} \times (100\% - 40\% \text{ shared walls}) = (0.2 \times 0.6) = 12\% \text{ overall increase}$$

The approximate cost of land per acre is weighted to reflect urban versus rural locations. Urban land is estimated at \$50,000. per acre, while rural land is estimated at \$25,000. per acre. While land prices vary widely based on location, these amounts are averages of land prices found in the Multiple Listing Service for Southern Arizona counties.

These numbers are predicated on improved land, with roads and utilities existing to the lot lines. Rural sites may have wells for domestic water supply and septic systems for waste disposal, rather than connections to a municipal water and sewer systems. Additional costs for infrastructure including roads, water, sewer, natural gas, and electricity must be factored for remotely sited rural land or undeveloped urban lots.

The economic and environmental advantages of infill development on vacant urban land is underscored by the cost savings realized in using existing infrastructure.

SUMMARY

|  |                           |
|--|---------------------------|
| Wall material:   | 2 x 6 frame/stucco        |
| Gross Floor Area:  | 1,224 sf                  |
| Exterior Surface Area:                                   | 2,657 sf                  |
| Ratio of Floor Area to Surface Area:                     | .46                       |
| Estimated cost of construction:                          | @ \$90/s.f. = \$ 110,160. |
| Density of land use:                                     | 4.5 RAC                   |
| <u>Cost of land per unit @ (\$50,000/Acre)/(4.5 RAC)</u> | <u>= \$ 11,111.</u>       |
| TOTAL ESTIMATED COST PER UNIT:                           | \$121,271.                |

The housing needs and expectations of a family with from two to four children in the contemporary U.S. Southwest are reflected in the subdivisions found in sun belt cities such as El Paso, Las Cruces, Tucson and Yuma. The suburban model has been followed by both private non-profit and government sponsored housing programs, including Habitat for Humanity, USDA, HUD and FmHA rural housing programs, as well as on Native American reservations by the Bureau of Indian Affairs and local tribal governments. It is a widely accepted standard of what constitutes an affordable, adequate family home.

PROGRAM

The Base Case home has a combined living/dining space adjoining a separate kitchen with a refrigerator, sink and stove. The dining area accommodates a table for six. There are three bedrooms, one slightly larger as a parents' bedroom, and two bathrooms, one of which is accessed from the parent's room. All bedrooms have closets. There is accommodation for a single car in a carport (shaded overhead, open on the sides). Space for clothes washing and drying machines is provided off the carport.

The typical house has a concrete slab-on-grade floor and wood stud walls finished with stucco at the exterior and gypsum board at the interior. The wall cavities and attic are insulated with fiberglass batting. The roof is pre-fab wood trusses with OSB sheathing and asphalt shingles. The house is mechanically heated and cooled by a heat-pump air conditioner, which must run much of the year as the house does not incorporate passive heating, cooling, or ventilating strategies.

The single-family detached house is placed in rows on blocks of subdivided land, each house in the middle of its lot with windows on all sides. There is a poor relationship of indoor to outdoor space. For example, if one wishes to dine outdoors in privacy one must bring food from the kitchen, across the carport, around the side yard, and finally to the backyard.

The Base Case represents a typical single-story southwestern neighborhood where emphasis is placed on accommodating the automobile. The resulting low-density development consumes a significant amount of land, and lacks a distinctive community form.

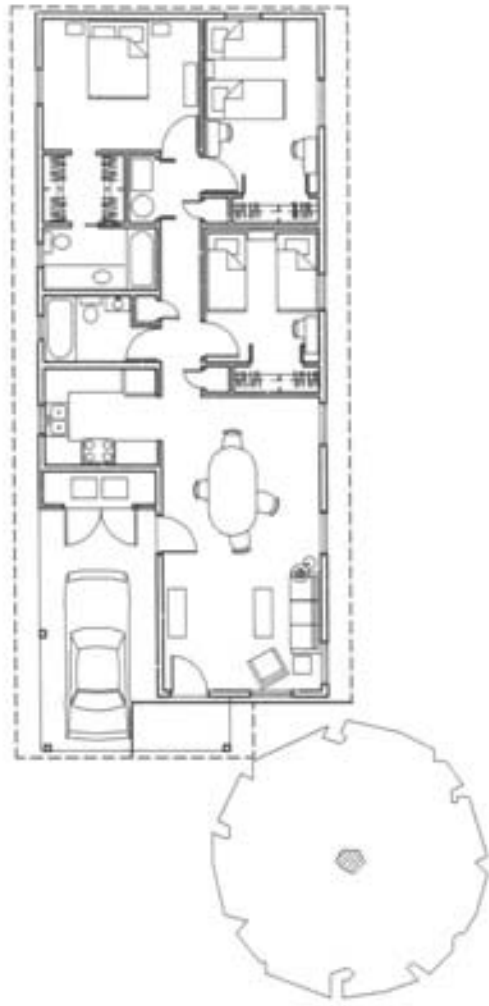

PLAN

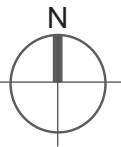

ELEVATION

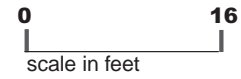

BASE CASE CONVENTIONAL SUBURBAN HOUSE  
EXTERIOR WALLS: 2x6 WOOD FRAME W/ STUCCO



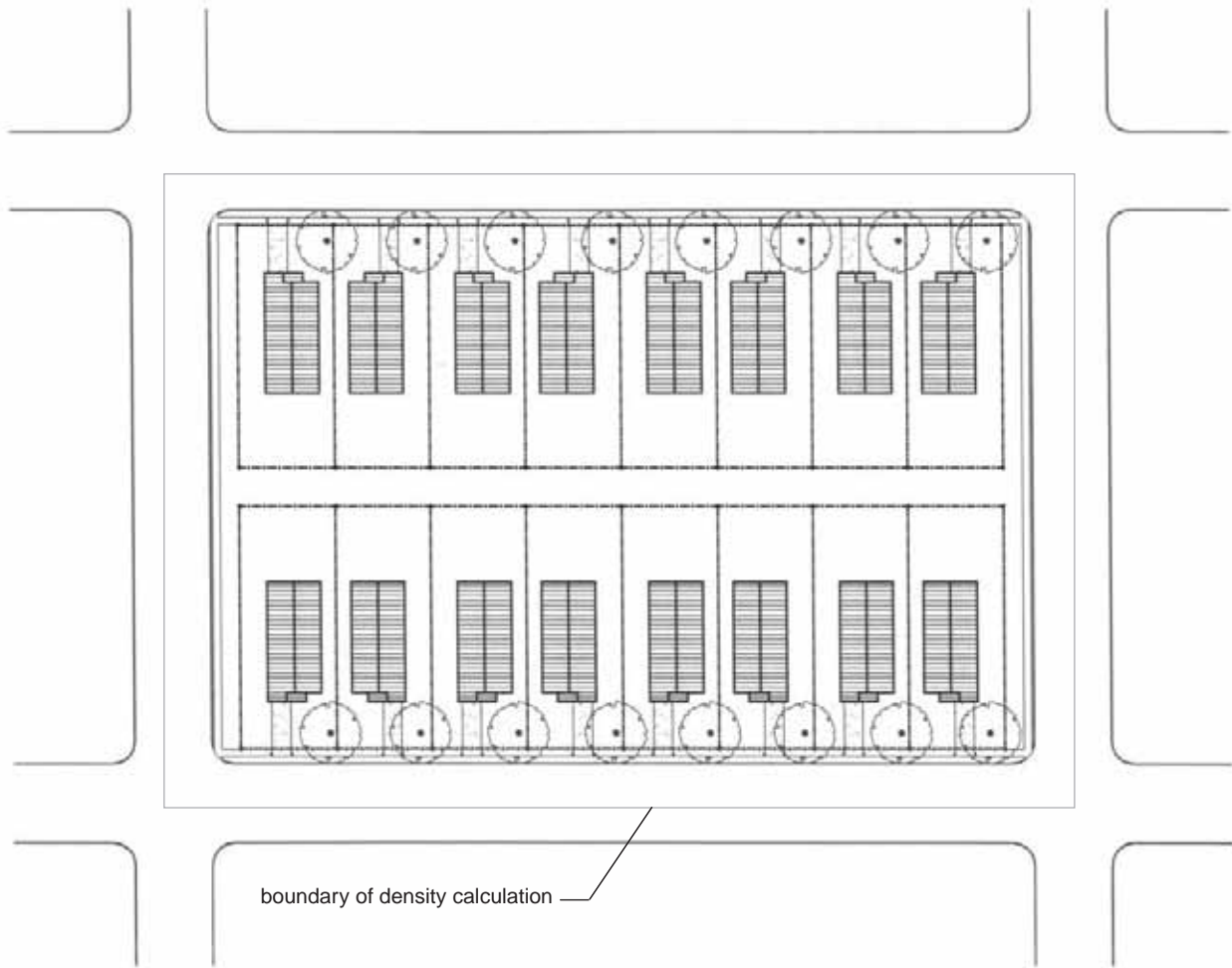

boundary of density calculation

0 100  
scale in feet

## NEIGHBORHOOD PLAN



"BASE CASE" CONVENTIONAL SUBURBAN HOUSE  
16 RESIDENCES / 3.52 ACRES = DENSITY 4.5 RAC

*“Homes which keep or improve their quality will retain or multiply the original investment and support the tradition of keeping houses in families from generation to generation. Thus houses become genuine and stable assets for families, in contrast to rented apartments.”*

---

Peter Land, *Economic Garden Houses*

SUMMARY

|  |   |                  |
|--|---|------------------|
| Wall material:   | straw bale exterior walls, rammed earth center wall |                  |
| Gross Floor Area:  | 1,320   | sf               |
| Exterior Surface Area:                                   | 2,532   | sf               |
| Ratio of Floor Area to Surface Area:                     | .52   |                  |
| Estimated cost of construction:                          | @ \$95/sf =   | \$125,400.       |
| Density of land use:                                     | 2.8   | RAC              |
| <u>Cost of land per unit @ (\$25,000/Acre)/(2.8 RAC)</u> | =   | <u>\$ 7,100.</u> |
| TOTAL ESTIMATED COST:                                    |   | \$ 119,300.      |

In rural areas with abundant inexpensive land, and where the detached single-family home is the preferred option, houses should be efficiently planned and responsive to the environment. Illustrated here is a modest interpretation of these goals based on the precedents of the traditional southwestern ranch house and bungalow. This prototype is recommended for small, isolated rural replacement housing, in clusters of from six to twelve houses.

FLOOR PLAN

The plan is a simple rectangle based on a 4-foot module to make the most of 4' straw bales, 24" on-center roof truss spacing and 4' x 8' roof sheathing. The plan measures 32' x 44' outside-to-outside. The exterior walls are proposed of 16" thick straw bale with lime/sand plaster. The window and door jambs carry the load of the roof, allowing the straw to serve as enclosure and insulation. A central wall running the length of the house is proposed of 16" thick rammed earth. This provides a central thermal mass to stabilize interior air temperatures. *The exterior straw bale walls provide high insulation value, while the central earth wall provides high thermal mass.* Roof framing is prefab wood or metal trusses with recycled cellulose insulation, OSB sheathing and corrugated metal roofing. Interior partitions are wood or metal studs with 5/8" gypsum board. Deep roof overhangs shelter the straw bale walls, and a porch wraps the corner of the living room to provide shaded outdoor living space.

Public and private spaces are separated by the central earth wall, with bedrooms along one side and the living/dining/kitchen on the other. Closets are placed between bedrooms to increase acoustic privacy. The children's rooms are grouped together, with the parent accessed by a private alcove. The bathroom design achieves the equivalent of two separate bathrooms with the plumbing of one bathroom. A tub/shower and sink together in one space, while a toilet and sink are in a separate space. This allows one family member to shower while another uses the toilet, effectively doubling the use of the bathroom at a reduced cost.

SITE PLAN

The hypothetical site is flat irrigated cropland as found in many areas of California, Arizona, New Mexico, and Texas along the U.S./Mexico border. The houses are grouped informally around a central loop road that gives access off a primary county road, of the type that runs along section lines between agricultural fields in the rural southwest. This removes the houses from the higher-traffic area, and creates a common area for kids to play and neighbors to barbecue. The open space improves privacy between houses, which are oriented primarily east-to-west for favorable solar exposure.



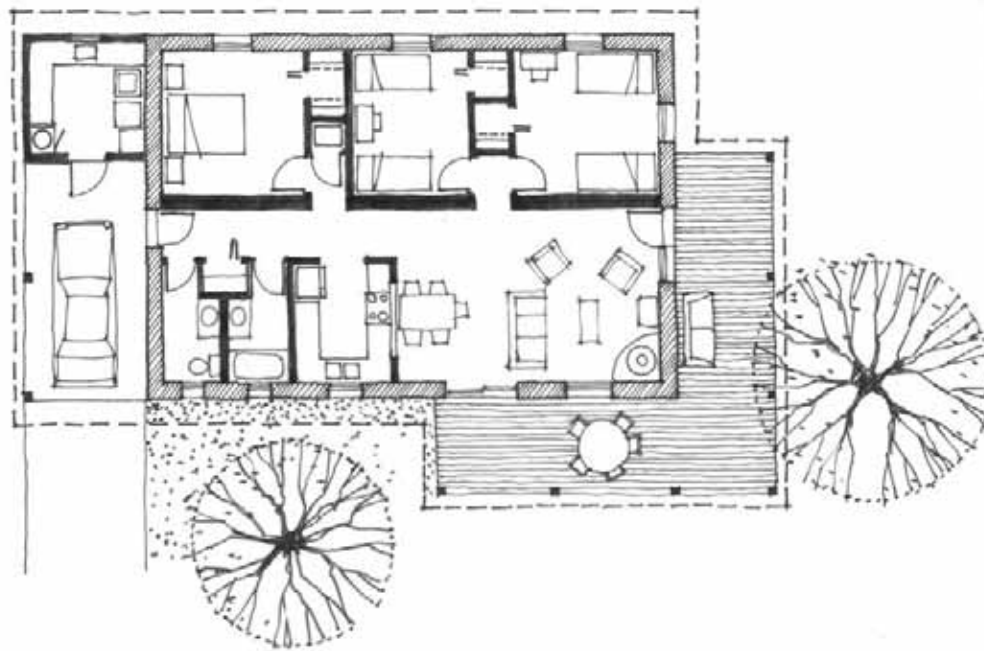

material legend

 straw bale

 rammed earth

PLAN

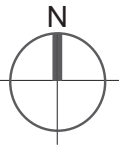

0 16  
scale in feet

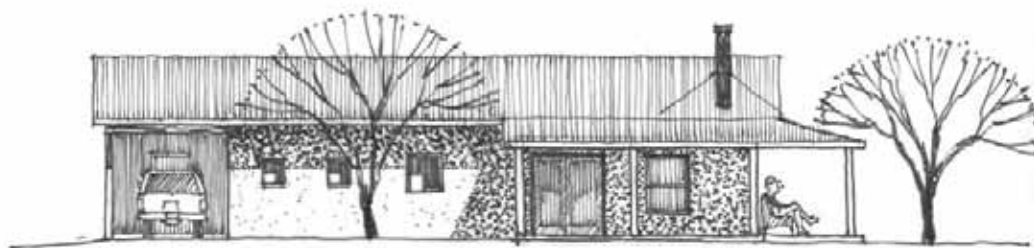

ELEVATION

RURAL DETACHED PROTOTYPE

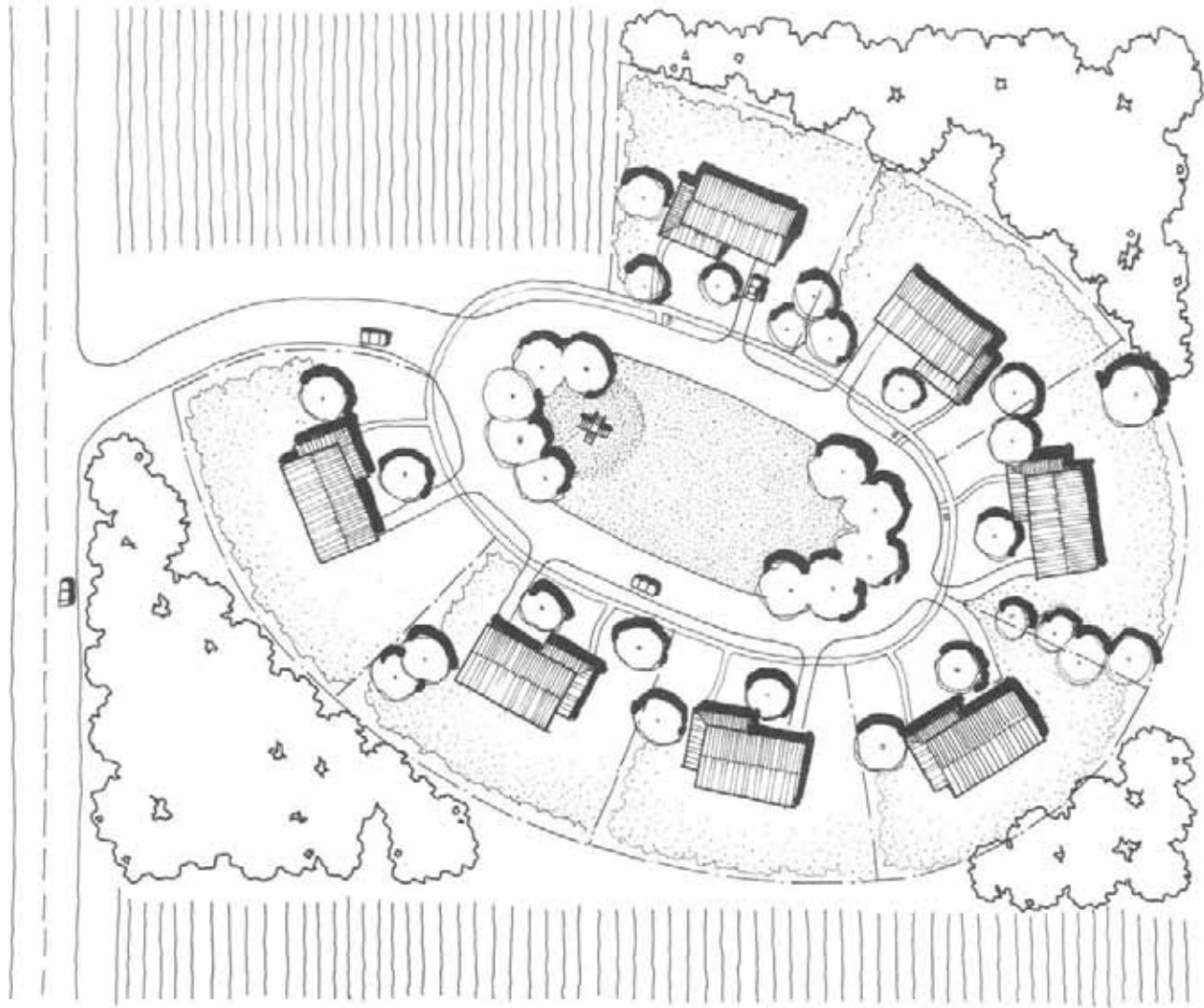

NEIGHBORHOOD PLAN

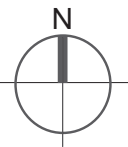

0 100  
scale in feet

*“The patio or court-yard house is well suited to contemporary needs... Its history in vernacular and architectural forms goes back well over 2,000 years... It permits light and ventilation from the inside patio, thus eliminating the need for space or openings around the perimeter of the dwelling and thereby permitting houses to be nested contiguously at high densities on relatively] small lots with considerable economies in infrastructure.”*

---

Peter Land, *Economic Housing: High Density, Low Rise, Expandable*

SUMMARY

|   |                                    |
|---|------------------------------------|
| Wall material:                                      | adobe, rammed earth or straw bale. |
| Gross Floor Area:                                   | 1,600 sf                           |
| Exterior Surface Area:                              | 1,987 sf                           |
| Ratio of Floor Area to Surface Area:                | .67                                |
| Estimated cost of construction:                     | @ \$100/sf = \$ 160,000.           |
| Density of land use:                                | 7.1 RAC                            |
| Cost of land per unit @ (\$50,000/Acre)/(7.1 RAC) = | \$ 7,000.                          |
| TOTAL ESTIMATED COST:                               | \$ 167,000.                        |

Where a closely-knit community form is desired for cultural, climatic or economic reasons, the “U” type courtyard house provides a good model. This example is drawn from the zaguán and courtyard tradition of the Southwestern U.S. and Northern Mexico. It can be built efficiently in groups of four, eight, or multiples of eight. Where multiple blocks are developed, the placement of housing blocks creates a central common park or plaza.

FLOOR PLAN

The “U” plan wraps a central courtyard on three sides, with public spaces fronting the street and bedrooms on the courtyard. Pedestrian entry is via a zaguán, that connects to the courtyard. A continuous porch connects the opposite sides of the courtyard. A parent’s bedroom suite is across the courtyard from the children’s wing for privacy. The bedrooms are large enough for two siblings each. Two full bathrooms are provided, as well as a utility room/laundry off the single carport. The house shares walls with its neighbors on two sides, while the carports also share a common partition.

Exterior walls are proposed of 16” thick stabilized adobe, left unplastered or (budget permitting) stuccoed with lime/sand plaster of varying integral colors. The wall thickness would allow either rammed earth or straw bale to be used as well. The roof structure is prefab wood or metal trusses with recycled cotton fiber insulation, OSB sheathing and corrugated metal roofing. Interior partitions are wood or metal studs with 5/8” gypsum board.

This prototype is superior in terms of functional arrangement and privacy. Due to the thick walls, the additional space of the zaguán entry, and the generous utility space provided, this 3 bedroom 2 bath prototype is larger than other options. At 1,600 s.f. it is 30 percent larger than the base case suburban model. To be competitive this prototype must achieve 30 percent savings in reduced land and infrastructure costs. A compact version of this house without the zaguán and with smaller rooms could be developed if necessary to make the approach feasible.

SITE PLAN

The assumed site is a gently sloping plain near a small agricultural town in the southwest. Changes in grade can be accommodated by stepping the floor elevations along the shared walls, as illustrated by the Street Elevation. Changes in plaster color of the walls or wainscoting can be used to distinguish the joined houses from one another. This type of housing creates pedestrian scaled urban architecture along the model of the Rio Sonora valley towns.



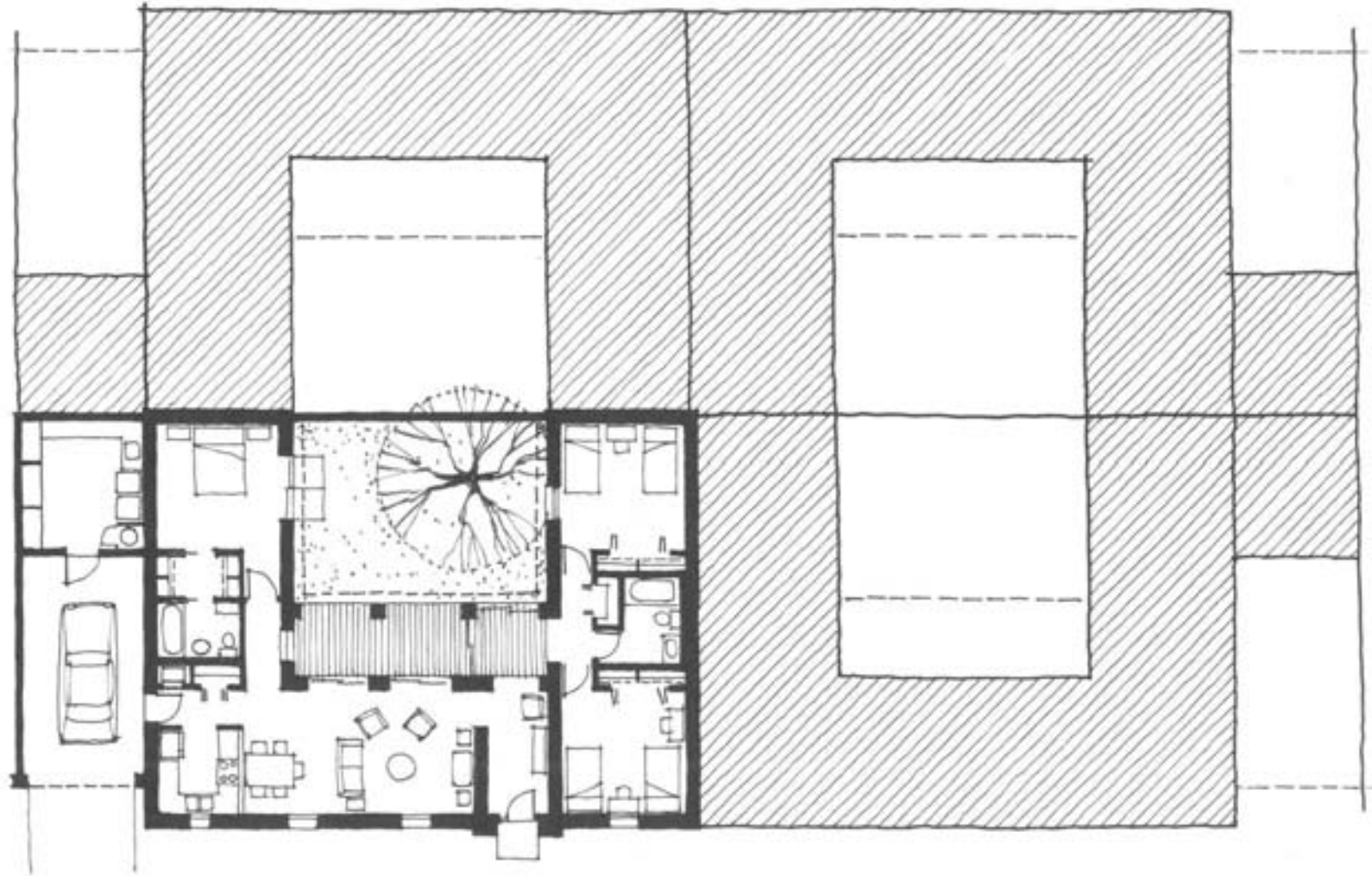

FLOOR PLAN

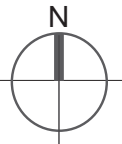

0 16  
scale in feet

“U” TYPE COURTYARD HOUSE  
EXTERIOR WALLS: 16” THICK ADOBE, RAMMED EARTH, OR STRAW BALE



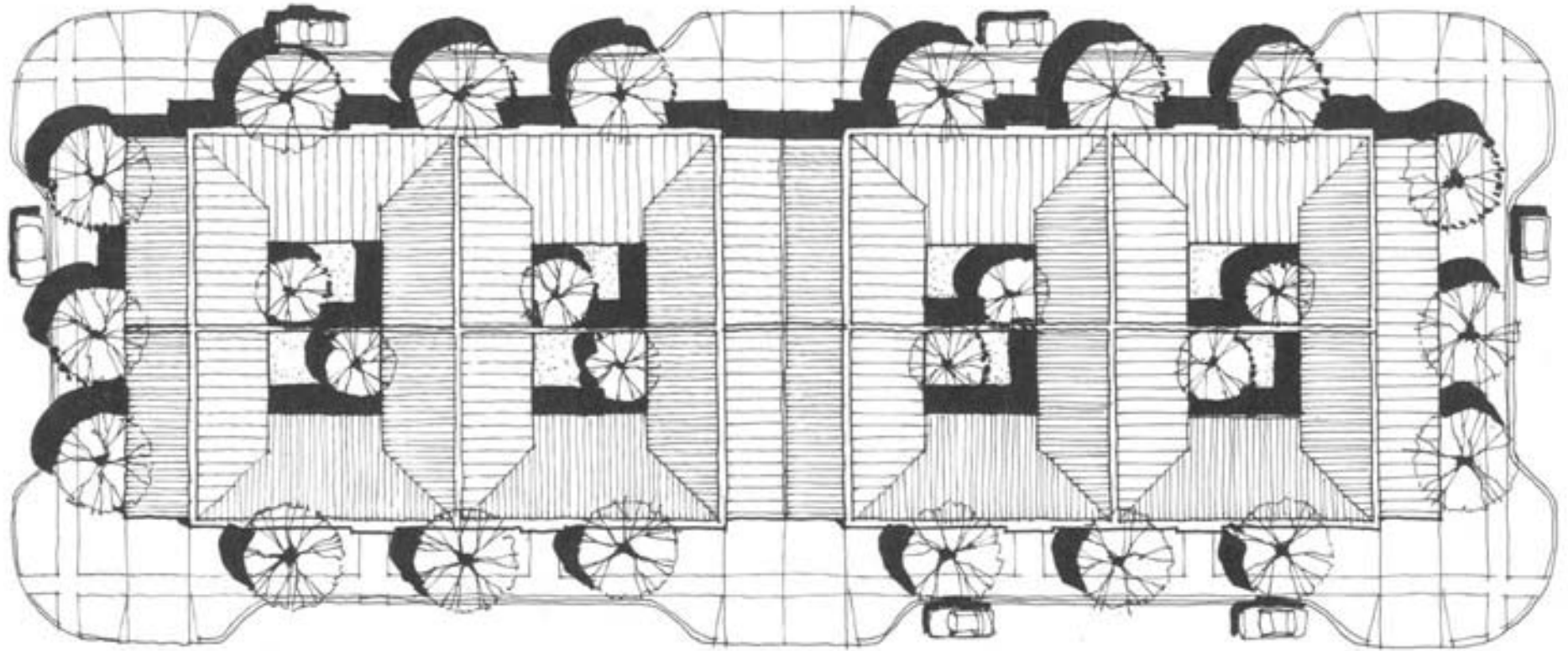

BLOCK PLAN

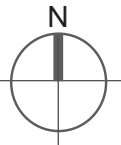

0 32  
scale in feet



STREET ELEVATION

"U" TYPE COURTYARD HOUSE: 8 RESIDENCES / 1.13 ACRES = DENSITY 7.1 RAC

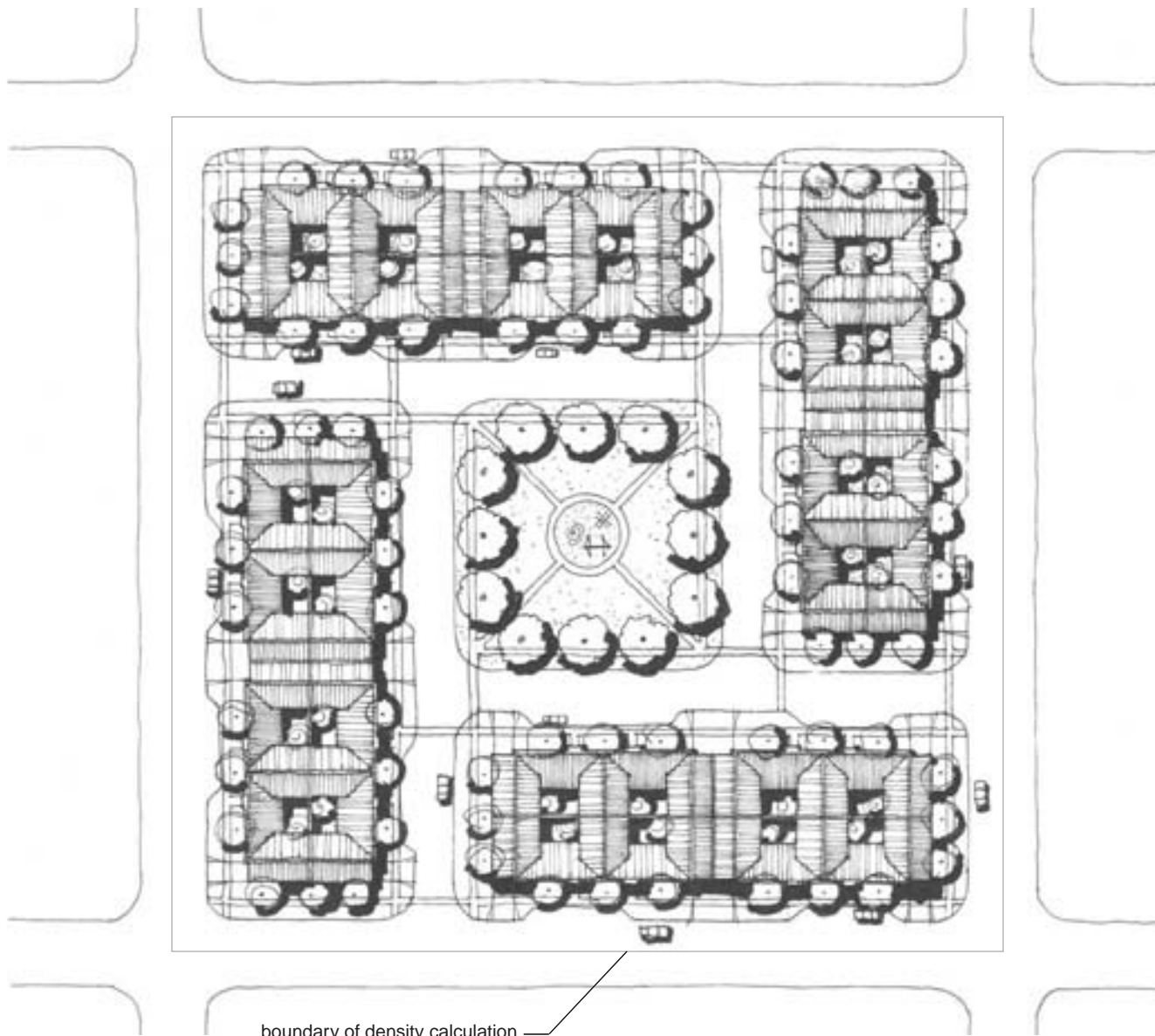

boundary of density calculation



"U" TYPE COURTYARD HOUSE: 32 RESIDENCES / 5.68 ACRES = DENSITY 5.6 RAC

SUMMARY

|   |                                    |
|---|------------------------------------|
| Wall material:                                      | adobe, rammed earth or straw bale. |
| Gross Floor Area:                                   | 1,311 sf                           |
| Exterior Surface Area:                              | 1,937 sf                           |
| Ratio of Floor Area to Surface Area:                | .63                                |
| Estimated cost of construction:                     | @ \$100/sf = \$ 131,000.           |
| Density of land use:                                | 6.9 RAC                            |
| Cost of land per unit @ (\$50,000/Acre)/(6.9 RAC) = | \$ 7,000.                          |
| TOTAL ESTIMATED COST:                               | \$ 138,000                         |

Based on Mexican examples in northern Sonora and southern Arizona, the “L” plan leaves a generous private patio or courtyard on one corner, and shares walls with adjacent dwellings on two sides. The house is brought forward to strengthen the pedestrian presence at the street, in stark contrast with the conventional subdivision’s garage-dominated street facade. As with the “U” plan, the “L” plan locates its outdoor space within the house in the form of a courtyard.

FLOOR PLAN

The public spaces, living, dining and kitchen, are located on the short leg of the “L” at the street front. The bedrooms are placed on the long leg of the “L”, each with direct access to the courtyard. A larger parent’s room is located at the farthest end of the patio, with its own bath and closet. Two children’s rooms connect to both the patio and an internal hall, which is necessary only at higher elevations in cooler zones. *At or below an elevation of 2,500 feet above sea level, the hallway may be omitted.* Deleting the hall would allow for larger bedrooms, accommodating a second child in each. As in Mexican examples, access to the bedrooms can be across the patio. A deep roof overhang protects the outdoor access, and shades windows and doors.

The exterior walls are proposed of adobe or rammed earth, exposed or plastered (budget permitting). As with all proposed prototypes, roof framing is prefab metal or wood trusses with corrugated metal roofing. Interior partitions, finishes and cabinets are economy standard. The special qualities of the house would come from the earthen walls, stained concrete floors and the courtyard space. This option has a large courtyard measuring 33’ x 38’, as compared with a 24’ x 24’ square courtyard including an 8’ wide porch at the “U” plan. This leaves open the possibility of adding a future room along the side of the courtyard behind the carport/laundry area. This might be a studio, a workshop or an additional bedroom/bathroom. This built-in flexibility is a distinct advantage of this plan type.

SITE PLAN

Following the principles of courtyard housing, the “L” plan permits high-density/low-rise development. The Block Plan and Neighborhood Plan illustrate the degree of density that may be achieved while yet maintaining privacy by virtue of the courtyard. The modularity of the block plan allows for subtle changes in grade between the groupings of houses. The overall neighborhood is focused on a central plaza with open space for recreation.



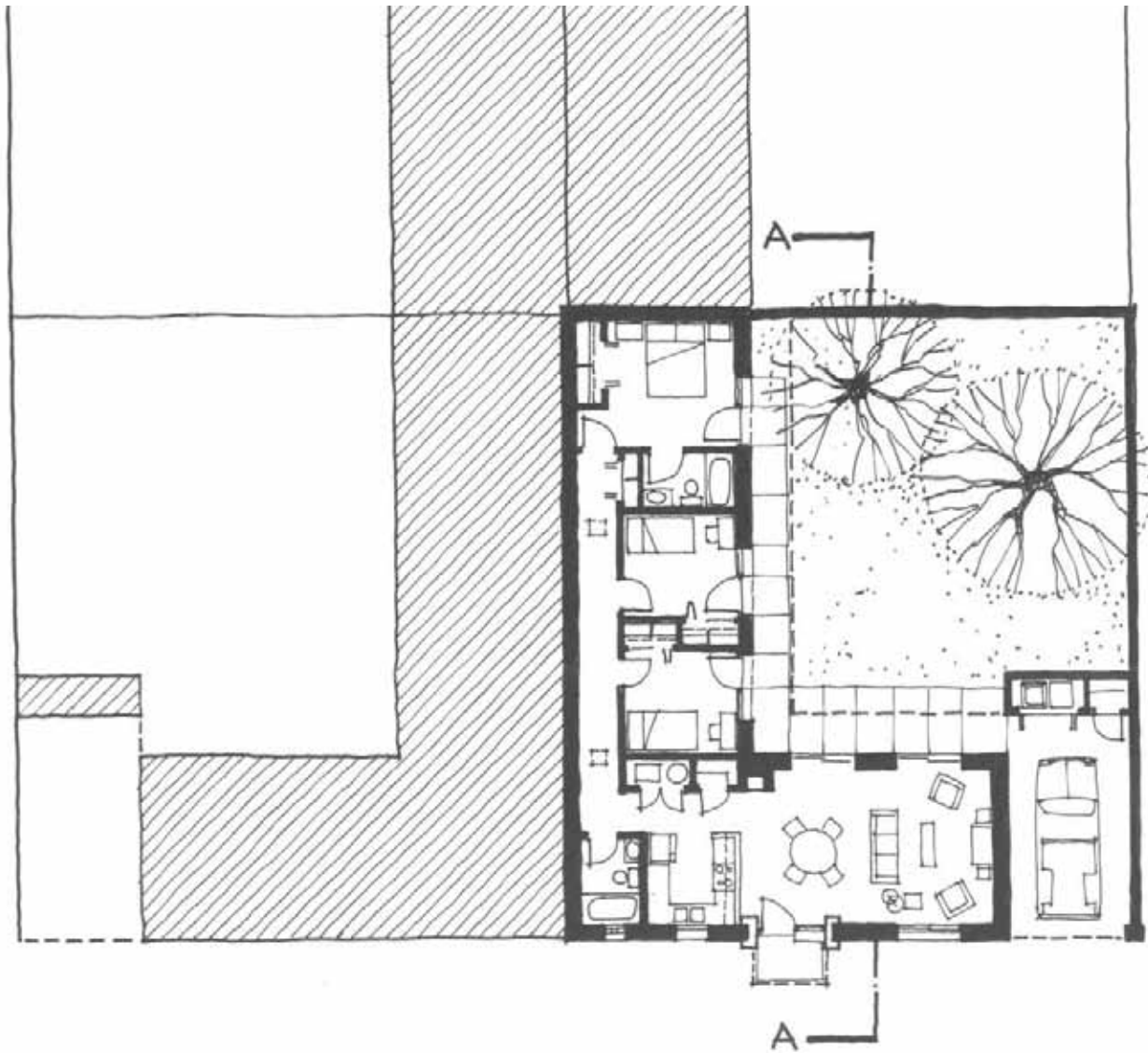

FLOOR PLAN



0 16  
scale in feet

"L" TYPE COURTYARD HOUSE  
EXTERIOR WALLS: 16" THICK ADOBE, RAMMED EARTH, OR STRAW BALE



SECTION A-A

0 8  
scale in feet

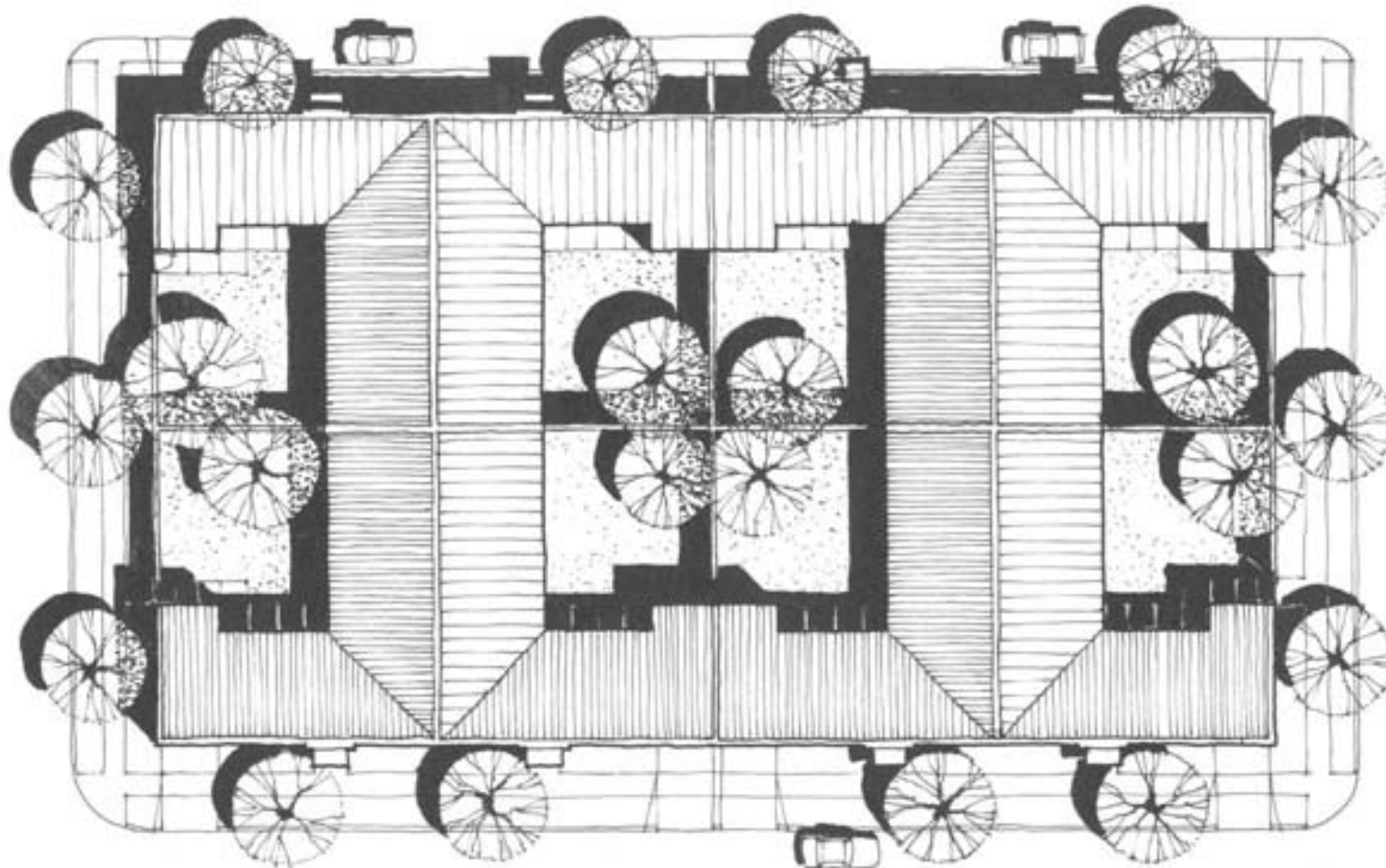

BLOCK PLAN

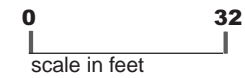
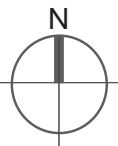

STREET ELEVATION

"L" TYPE COURTYARD HOUSE: 8 RESIDENCES / 1.16 ACRES = DENSITY 6.9 RAC

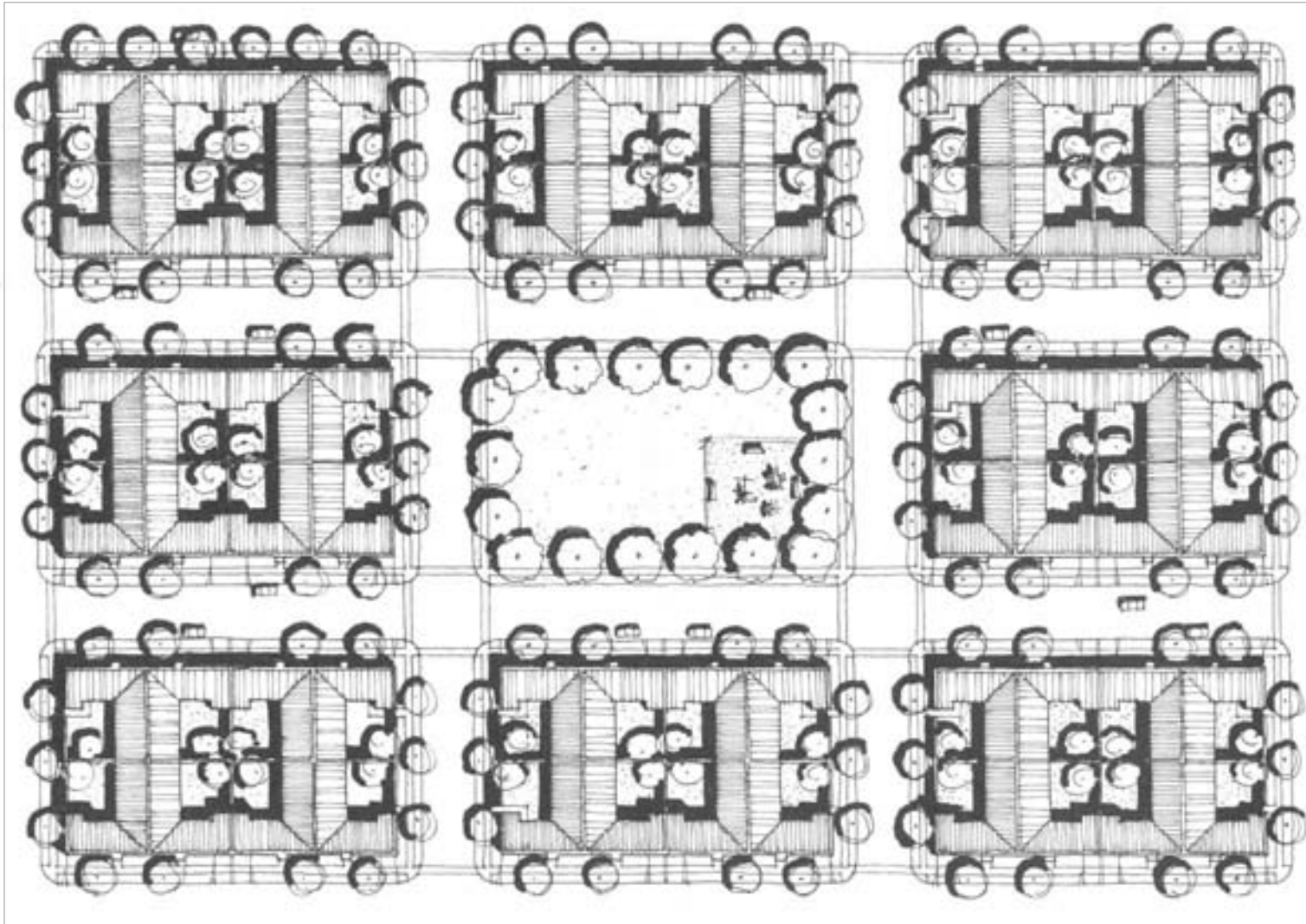

boundary of density calculation

NEIGHBORHOOD PLAN

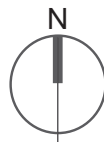

"L" TYPE COURTYARD HOUSE: 64 RESIDENCES / 9.7 ACRES = 6.6 DENSITY RAC

*“Characteristics of houses and neighborhood:*

- a) Individual houses to create an optimum habitat for contemporary living needs in compact groupings which maintain independence and allow [human interpersonal] contact.*
- b) Houses oriented to interior patio gardens for family privacy, outside extension of living [space] and full use of all lot area.*
- c) Expandable houses which can increase in size from minimal units to ones of optimum area with internal flexibility to accommodate changing family space needs.*
- d) Low unit costs achieved through simplified unit design, maximum use of minimum space, improved building methods and dimensional standardization.*
- e) High density and compact development to (a) minimize distances and introduce walking as the main form of movement and communication; (b) reduce the extension of infrastructure and (c) use land efficiently.*
- f) Pedestrian streets as the main spatial focus in the neighborhood onto which face clusters of community facilities, such as shops, schools, kindergartens, etc., within walking distance from all houses.*
- g) Carefully relating vehicles and pedestrians for safety, secure family life, and tranquil movement for walkers.*
- h) Landscaped overall environment of small community gardens, patios, lanes with trees and planting.”*

---

Peter Land, *Economic Housing: High Density, Low Rise, Expandable*



SUMMARY

|   |   |               |
|---|---|---------------|
| Wall material:  | straw bale infill walls w/ CMU piers & glue-lam beams |               |
| Gross Floor Area:   | 1,408 sf  |               |
| Exterior Surface Area:                                      | 748 sf  |               |
| Ratio of Floor Area to Surface Area:                        | 1.88  |               |
| Estimated cost of construction:                             | @ \$95/sf =   | \$ 133,760.   |
| Density of land use:  | 11.1 RAC  |               |
| <u>Cost of land per unit @ (\$50,000/Acre)/(11.1 RAC) =</u> | <u>\$</u>   | <u>4,500.</u> |
| TOTAL ESTIMATED COST:                                       |   | \$ 138,260.   |

Where the greatest efficiencies of land use and environmental performance are sought, the two-story prototype is most relevant. This approach is derived directly from Acoma Pueblo of New Mexico. Parallel rows of multi-story joined dwellings are oriented towards the south. Each dwelling has terraces providing private outdoor space for each family. Privacy between adjacent terraces is achieved by means of a stair-stepping wall, which lends visual screening while yet allowing sunshine to reach the terrace and house interior.

FLOOR PLAN

Each house is accessed through small private courtyards, one each at ground level on the south and north sides. The east and west sides of each unit are common walls shared with adjoining houses, achieving a high level of economic and environmental efficiency. The ground floor includes the public spaces, while the private spaces are on the second floor accessed by a centrally located stair and utility core. As illustrated in both plan and cross section, second floor terraces/balconies at the north and south are accessible from each of the three bedrooms. The parent's suite is located across the central core from the children's rooms for privacy's sake. The terraces provide a covered porch below at the ground floor. Each dwelling has a single carport and exterior utility/mechanical room.

Walls are proposed of straw bale infill with reinforced concrete masonry (CMU) piers providing vertical and lateral support. Straw bale when finished with lime/sand plaster on both sides is an effective acoustic as well as thermal insulator, isolating the units one from the other. Roof and second floor construction is composite wood framing. Glued-laminated beams are used where spans require. This is a spacious house within a compact form.

SITE PLAN

Drawing from the urban form of Acoma, rows of houses are aligned facing south along the east-west axis. A common space is located between the two rows of housing. This area might include a play ground, a meeting and recreation room, or (community budget permitting) a swimming pool. Trees are located to shade the exposed end walls of the east and west units. This example represents an efficient use of both land and building technology.



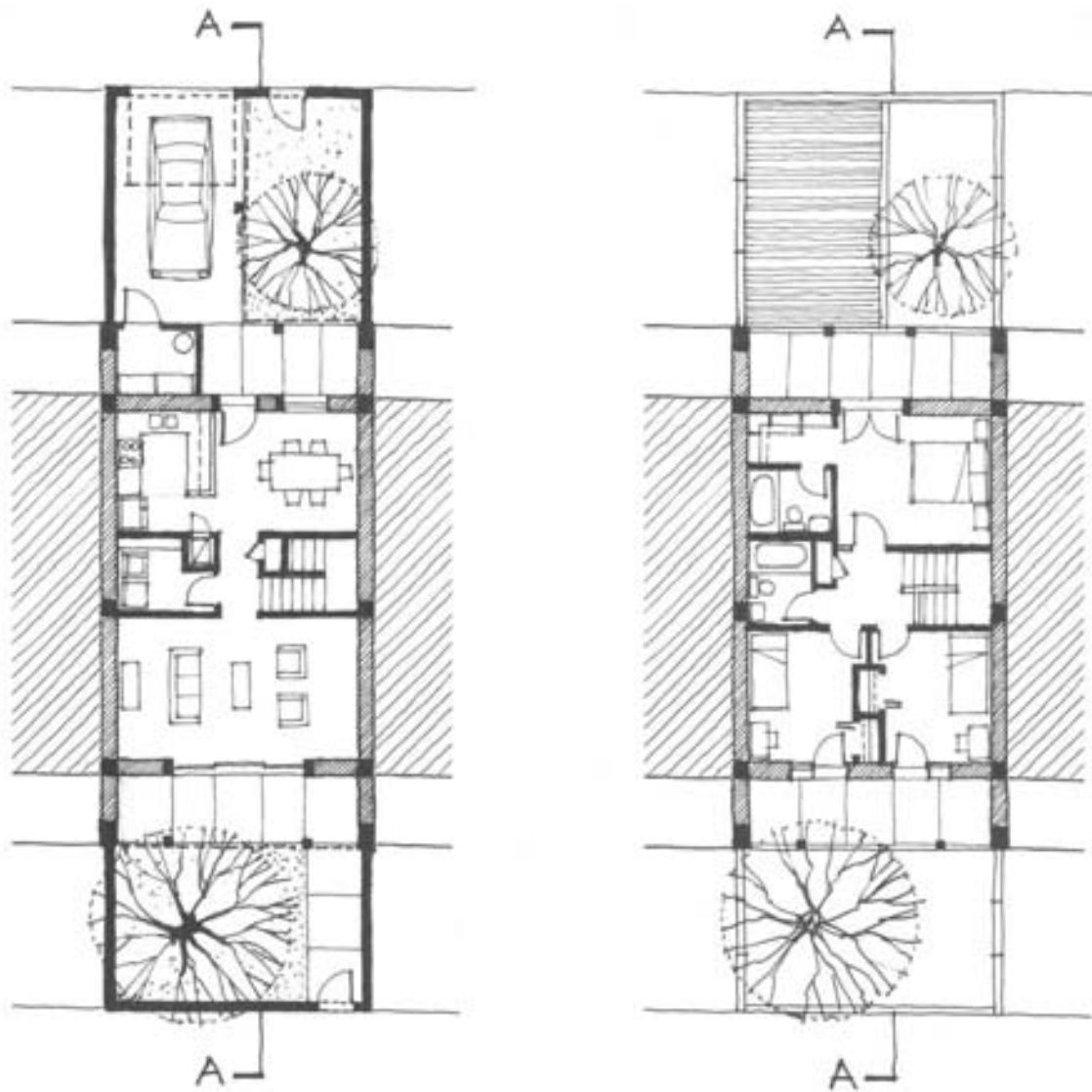

1ST FLOOR

2ND FLOOR

2-STORY ROW HOUSE (POST AND BEAM STRAW BALE INFILL)

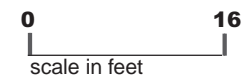

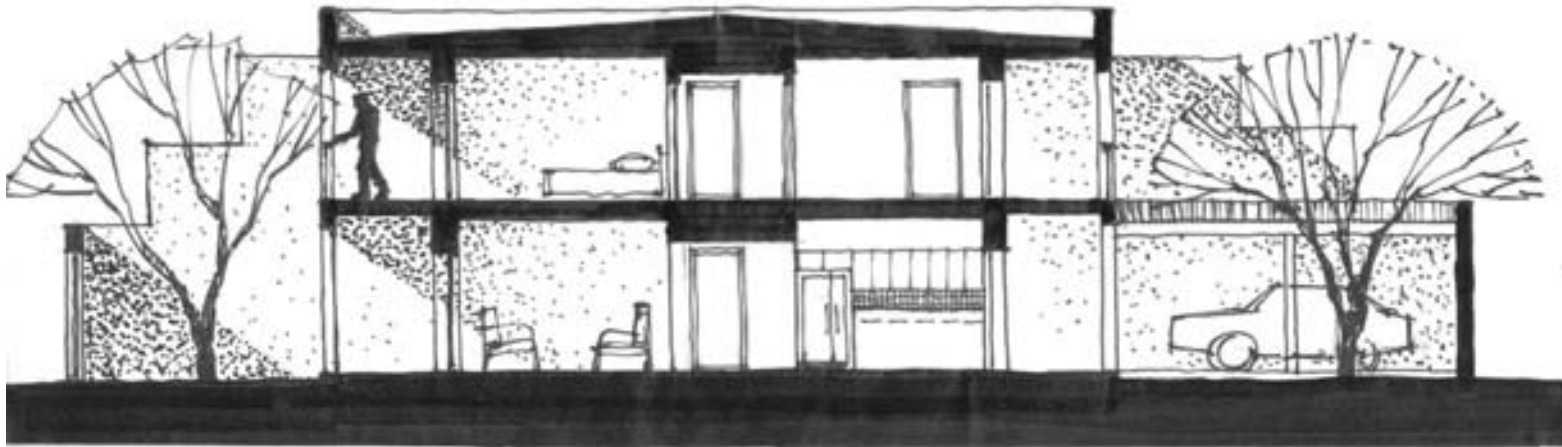

SECTION A-A

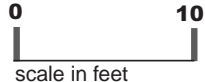

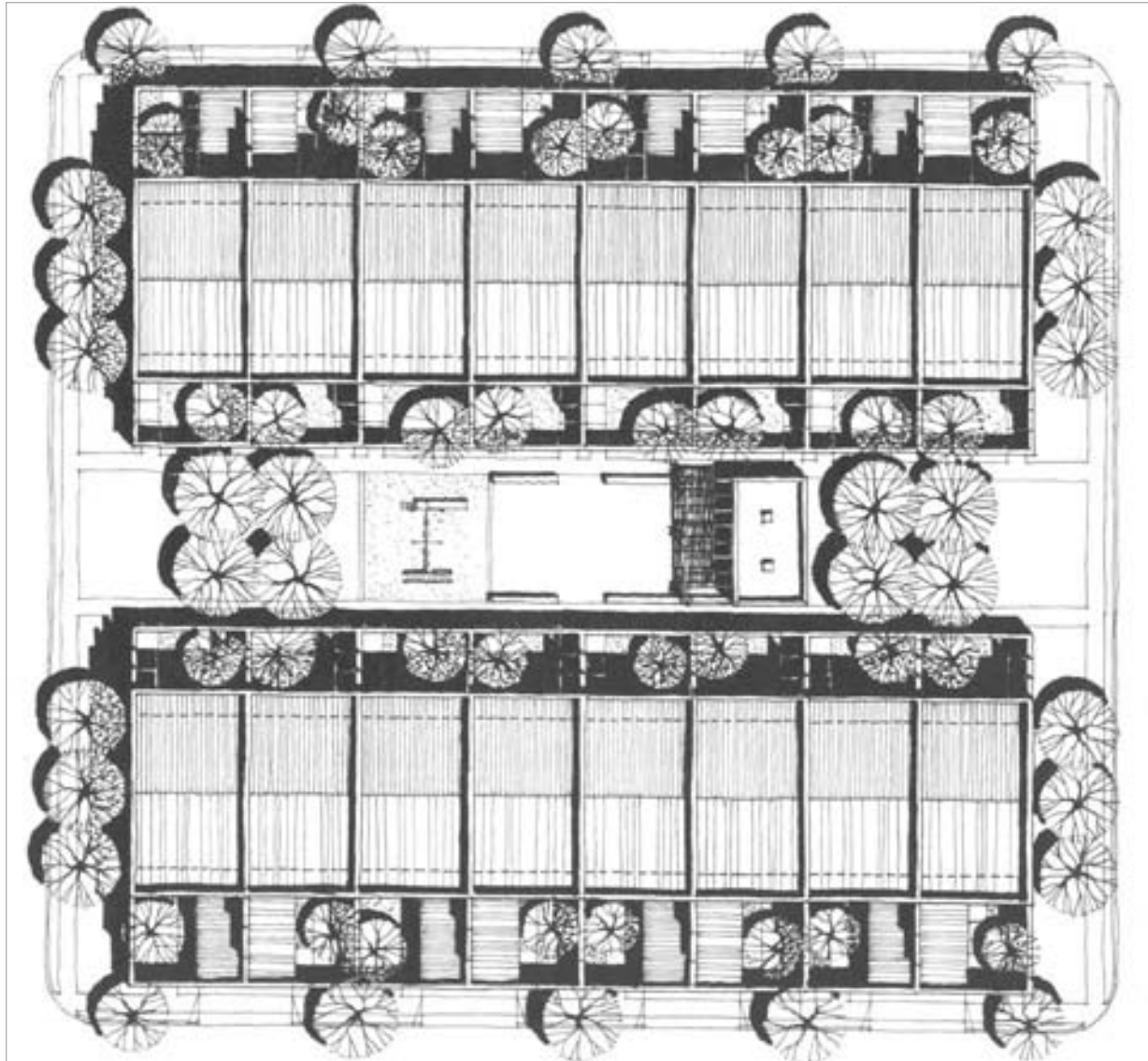

boundary of density calculation

NEIGHBORHOOD PLAN

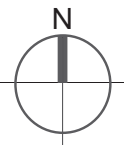

0 20  
scale in feet

2- STORY HOUSE: 16 RESIDENCES / 1.44 ACRES = DENSITY 11.1 RAC

## FINAL REMARKS

---

We hope this study of regional building traditions will support alternative design and construction methods in the production of affordable housing in the U.S. Southwest. Nonprofit developers, builders, planners and architects are invited to build upon the work begun here. Using traditional materials and design concepts in new housing can both reduce energy use within the home and result in healthier communities. Nonprofit developers are encouraged to look beyond the first cost of building houses to consider life-cycle costs, while creating more humane and culturally sensitive environments for southwestern families.

Traditional housing and community planning ideas can still be relevant to new developments, even where the higher cost of materials, such as adobe or rammed earth, prohibit their use. For example, our study suggests that rammed earth is feasible for affordable housing only if it is largely subsidized by volunteer labor. Where this is not possible, and where conventional materials must be used, the ranch house, the bungalow, the courtyard and the zaguán still have much to tell us regarding the design of individual houses and neighborhoods.

Thus, even if traditional materials cannot be used for financial or practical reasons, the affordable housing community is encouraged to apply the valid ideas embodied in traditional housing models.



# END NOTES

Authors, primary sources, references and consultants for each chapter.

## chapter 1 PROBLEMS & SOLUTIONS

---

- author                      Bob Vint, Architect
- primary source            Travel research and documentary photography of border region, Bob Vint and Arthur Vint
- reference                   Veregge, Nina. "Transformations of Spanish Urban Landscapes in the American Southwest, 1821 – 1900." *Journal of the Southwest*. Volume 35, Number 4, (Winter 1993), pp.371 – 459.

## chapter 2 DESIGN

---

- author                      Bob Vint, with contributions by John Messina, AIA
- primary sources           Measured drawings of historic structures, Christina Neumann and Bob Vint
- references                Books
- Houk, Rose. *Casa Grande Ruins National Monument* Southwestern Parks and Monuments Association, Tucson 1987.
- Nabokov, Peter. *Architecture of Acoma Pueblo* Santa Fe: Ancient City Press, 1986.
- Stilgoe, John R. *Common Landscape of America, 1580 to 1845* Yale University Press, New Haven 1982.
- Reports
- A History of the Edward Nye Fish House*, Tucson Museum of Art, Lyons, Bettina 1989.
- Heart of the Empire*, Historic Structures Report (incomplete) National Park Service, Southwest Region, 1994.
- The Old Adobe: Charles O. Brown House*, Arizona Historical Society, 1980.
- Tucson Historic Sites*, Historic Areas Committee, Tucson Community Development Program, 1969.

## chapter 3 MATERIAL

---

authors Bob Vint (adobe, foundations and roofs) and Christina Neumann (rammed earth and straw bale)

references Books

Easton, David. *The Rammed Earth House*.  
White River Junction, Vermont: Chelsea Green Publishing Company, 1996.

Houben, Hugo and Guillaud, Hubert. *Earth Construction: A Comprehensive Guide*.  
London: Intermediate Technology Publications, 1994.

McHenry, Paul Graham, Jr. *Adobe and Rammed Earth Buildings*. Tucson: University of Arizona Press. 1989.

Myhrman, Matts and MacDonald, S.O. *Build it with Bales: A Step-by-Step Guide to Straw-Bale Construction*.  
Tucson: published by the authors, 1997.

Roberts, Caroline.

Tibbets, Joseph M. *The Earthbuilders' Encyclopedia*. New Mexico: Southwest Solaradobe School, 1989.

### Conference Proceedings

*Out of Earth: First National Conference on earth Buildings*, Centre for Earthen Architecture  
Plymouth School of Architecture, UK, 1994.

*6th International Conference on the Conservation of Earthen Architecture*.  
Los Angeles: The Getty Conservation Institute. 1990.



## chapter 4 PERFORMANCE

---

|             |   |                         |
|-------------|---|-------------------------|
| author      | Christina Neumann, LEED <sup>(TM)</sup> A.P. with contributions by Bob Vint   |                         |
| consultants | Structural engineer:  | Steven Hess, P.E        |
|             | Materials testing:  | Ralph M. Pattison, P.E. |
|             | Energy modeling:  | Nader Chalfoun, Ph.D.   |
| references  | Fathy, Hassan. <i>Natural Energy and Vernacular Architecture: Principles and Examples with Reference to Hot Arid Climates</i> . Chicago: University of Chicago Press, 1986. |                         |
|             | Moore, Fuller. <i>Environmental Control Systems: Heating Cooling Lighting</i> . McGraw Hill, Inc., 1993.  |                         |
|             | Cofaigh, Eoin O., et. al. <i>The Climatic Dwelling</i> . London: James & James (Science Publishers) Ltd., 1996.   |                         |

## chapter 5 PROTOTYPES

---

|                 |  |                     |
|-----------------|--|---------------------|
| Author          | Bob Vint, Architect  |                     |
| Primary Sources | Architectural design and presentation of prototypes:   | Bob Vint, Architect |
|                 | Drafting assistance and graphic layout:  | Paul Briggs, A.I.T. |
| References      | Land, Peter. <i>Economic Garden Houses: High Density Development</i> . Chicago: College of Architecture, Planning and Design, Illinois Institute of Technology. 1977.                                  |                     |
|                 | Land, Peter. <i>Economic Housing: High Density, Low Rise, Expandable Unit design, building technology, urban structure</i> Champagne-Urbana: Department of Architecture, University of Illinois. 1975. |                     |

# ANNOTATED BIBLIOGRAPHY

---

authors      John Messina, AIA with contributions by Bob Vint

## HISTORICAL PERSPECTIVE

---

### books

Bourgeois, Jean-Louis. *Spectacular Vernacular: A New Appreciation of Traditional Desert Architecture*.

Salt Lake City: Gibbs M. Smith, Inc. 1983.

A well-illustrated worldwide survey of earthen structures, with an emphasis on North Africa. A large format edition with improved reproductions was republished in 1990.

Brown, Arthur T. *Arthur T. Brown, FALA: Architect, Artist, Inventor*.

Tucson: College of Architecture Library, University of Arizona, 1985.

Monograph on the work of a southwestern modernist architect who was a pioneer of passive solar design. Contains photographs and floor plans of several of his significant projects, as well as a revealing commentary on the architectural profession over the 20th century.

Bunting, Bainbridge. *Early Architecture in New Mexico*.

Albuquerque: University of New Mexico Press, 1976.

A richly illustrated account of 1600 years of New Mexico's architectural history, beginning with fourth-century pit houses and ending with the Territorial period. Many historic photographs of buildings and details accompany the text.

Bunting, Bainbridge. *Taos Adobes: Spanish Colonial and Territorial Architecture of the Taos Valley*.

Albuquerque: University of New Mexico Press, 1964.

A detailed examination of twelve domestic structures of the northern New Mexico region. Includes photographs, descriptions and measured drawings.

Bunting, Bainbridge. *Of Earth and Timbers Made: New Mexico Architecture*.

Albuquerque: University of New Mexico Press, 1974.

Primarily a photographic study of northern New Mexico vernacular architecture. Many well reproduced photographs of buildings and details including doors, portales, windows and carpentry. A brief yet informative text by the noted architectural historian Bunting.

Conzen, Michael P., ed. *The Making of the American Landscape*.  
New York: Routledge, 1994.

A collection of essays, by leading scholars, concerning the evolution of the cultural American landscape. Historical forces that shaped the land are viewed from the perspectives of ethnic, cultural and environmental movements. A very thoughtful book.

Crouch, Dora P., Garr, Daniel, and Mundigo, Axel. *Spanish City Planning in North America*.  
Cambridge, Mass.: MIT Press, 1983.

The Spanish conquest and settlement of the New World led to the building of almost 350 new cities in accordance with a set of edicts known as the “Laws of the Indies.” These laws embodied Renaissance concepts of urban form such as regular street patterns, harmonious groupings of major institutions around a central plaza, and provisions for orderly expansion features that are still relevant for town and community planning today. In examining North American Spanish cities, including Santa Fe, Los Angeles and even St. Louis, this book presents a neglected aspect of American urban history.

Garrison, G. Richard and Rustay, George W. *Early Mexican Houses*.  
Stamford: Architectural Book Publishing Co., Inc., 1990.

This is a high quality reprint of a study of Mexican architecture by two American architects who traveled throughout central Mexico in the 1920s. Their exquisite measured drawings and photographs are among the best documents recording traditional Mexican architecture.

Giebner, Robert C. and Harris J. Sobin, eds. *Barrio Historico Tucson*.  
Tucson: College of Architecture, University of Arizona, 1972.

A study by architecture faculty and students of what remains of Tucson’s Mexican-American barrio, unfortunately, conducted shortly after much of the barrio was destroyed during “urban renewal.” Contains measured floor plans and elevations of numerous examples of true Sonoran domestic architecture. A rare and out of print document, possibly only available through university libraries.

Houk, Rose. *Casa Grande Ruins National Monument*  
Tucson: Southwest Parks and Monuments Association, 1987

An historical and archeological guide to the Hohokam pre-historic site in central Arizona. Concise, with valuable plans and historic photos.

Hyer, Sally. *Recording a Vanishing Legacy: The Historic American Buildings Survey in New Mexico 1933 – Today*.  
Santa Fe: Museum of New Mexico Press, 2001.

An overview of New Mexico’s historic domestic, religious, and civic architecture, including examples from the Indian pueblos, as recorded by the Historic American Buildings Survey (HABS). Contains more than thirty measured drawings and descriptions, of which only a few are residential. Nevertheless, a valuable publication on the regional history of an important National Park Service program to record historic buildings. HABS was created under FDR’s “New Deal” during the Depression to put unemployed architects to work. The program continues to the present day.

Jacobs, Jane. *The Death and Life of Great American Cities*.

New York: Vintage Books, 1961.

Still relevant after almost a half century, this book by the great urbanist describes what went wrong during urban renewal efforts in the United States. With vivid descriptions of traditional neighborhoods, the author points a positive path to more livable streets and cities. This book is to towns and cities as Rachael Carson's *The Silent Spring* is to the natural environment.

Jeffery, R. Brooks and Nequette, Anne. *A Guide to Tucson Architecture*.

Tucson: University of Arizona Press, 2001.

A guide to the three centuries of Tucson's architecture heritage. Contains descriptions and annotated photographs of some houses; although, unfortunately, there are no floor plans. Still this is a helpful study of the architecture of a multi-cultural southwestern city. The historical introduction offers a critical commentary of post-war development in Tucson.

McAlester, Virginia and Lee. *A Field Guide to American Houses*.

New York: Alfred A. Knopf, 1989.

An essential book for anyone interested in American vernacular architecture, with many black and white photographs and excellent illustrations. Contains clear and factual descriptions of each stylistic period, illustrating the salient features of virtually every house type in the United States.

McCoy, Esther. *Case Study Houses, 1945-1962*.

Los Angeles: Hennessey & Ingalls, Inc., 1977.

Survey of a unique program to design and build modern houses, supported by the no longer existing West Coast magazine, *Arts and Architecture*. The illustrated houses, designed by successful post World War Two architects, offer examples of the type of open-plan design, utilizing much plate glass, that allow interior and exterior spaces to flow together. Interesting ideas that are valid for mild climates, although with too much glass for the desert.

McHenry, Paul Graham, Jr. *Adobe and Rammed Earth Buildings*.

Tucson: University of Arizona Press, 1989.

The late author was a champion of earth building long before the current revival began. Provides a brief history, and explains contemporary practices in writing, drawing and photos. A well-illustrated introduction to adobe and rammed earth construction.

Nabokov, Peter. *Architecture of Acoma Pueblo*.

Santa Fe: Ancient City Press, 1986.

An excellent document based on Historic American Buildings Survey (HABS) drawings and photos of the magnificent "Sky City" (Acoma Pueblo) in northern New Mexico. Acoma is among the oldest continuously occupied settlements in the United States, and its architecture, a mixture of adobe and stone construction is an indigenous example of high-density/low-rise urban form. Acoma presents an interesting model for future planned communities in the U.S. Southwest.

Nabokov, Peter and Robert Easton. *Native American Architecture*.

New York: Oxford University Press, 1989.

An outstanding study of the traditional architecture of Native Americans in North America. The authors discuss the building practices of the people, as well as their symbolic meanings. Very well illustrated with drawings and vintage photographs. Southwestern peoples are well represented within this comprehensive document.

Polyzoides, Stefanos, et.al. *Courtyard Housing in Los Angeles*.

New York: Princeton Architectural Press, 1992.

A thorough study by University of Southern California architecture faculty and students of an important building type: multi-family courtyard housing. While the publication focuses on small apartment complexes built during the pre-World War Two era in Los Angeles, this building type still has great relevance for new housing, multi-family or single-family, in today's Southwest. (see: [www.mparchitects.com](http://www.mparchitects.com))

Rapoport, Amos. *House Form and Culture*.

Englewood Cliffs: Prentice-Hall, Inc., 1969.

A survey of vernacular architecture from around the world, with a small section devoted to the American Southwest. The author, an architect and anthropologist, uses the lens of cultural anthropology in this valuable contribution to the study of folk building practices.

Scully, Vincent. *Pueblo, Mountain, Village, Dance*.

Second Ed. Chicago: The University of Chicago Press, 1989.

By analyzing the relationships between landscape, ceremony and Pueblo dwellings, the author, an eminent architectural historian, explores the Southwest Native Americans' view of the natural world and how this cosmology informed their architecture. Illustrated with numerous photographs of Pueblo architecture and rituals.

Sergent, John. *Frank Lloyd Wright's Usonian Houses*.

New York: Whitney Library of Design, 1984.

In the mid-20th century, Frank Lloyd Wright developed and built a series of efficient, cost effective, yet beautiful and livable houses. The author of this publication relates the story of the "Usonian House," as Wright called his prototype. Includes many photographs and floor plans of an architecture that remains relevant (although Wright's suburban planning approach is a limitation).

Spears, Beverly. *American Adobes: Rural Houses of Northern New Mexico*.

Albuquerque: University of New Mexico Press, 1986.

A collection of photographs with an informative text documenting the vernacular dwellings of northern New Mexico. Mostly exterior views of adobe houses with pitched metal roofs that have become models for a revival style popular in the Santa Fe area.

Stewart, Janet Ann. *Arizona Ranch Houses: Southern Territorial Styles, 1867-1900*.

Tucson: University of Arizona Press and Arizona Historical Society, 1974.

The most complete book on the ranch houses of southern Arizona from the latter part of the 19<sup>th</sup> century. Contains exterior and interior photographs, and several floor plans. The author's text provides interesting historical information.

Stilgoe, John R. *Common Landscape of America, 1580 to 1845*.

New Haven: Yale University Press, 1982.

A concise study of how the American landscape, from farmsteads to cities, came about prior to the Civil War. Because the author stresses how the northern European sensibility shaped much of North America, the book is not particularly strong on the Southwest. However, a small section is devoted to the New Mexican settlement of Chimayo.

Upton, Dell, ed. *America's Architectural Roots: Ethnic Groups that Built America*

New York: John Wiley & Sons, Inc., for the National Trust for Historic Preservation, 1986.

An excellent guide to the various forms of American domestic architecture, with special emphasis on the influences of different immigrant groups. The section on the Hispanic Southwest, by Joe S. Graham, provides a brief essay on mission and domestic architecture from California to Texas. Another section, by Kathleen Deagan, discusses the Spanish influence on the architecture of the Southeastern United States. Two interesting comparisons.

Wilson, Chris. *Facing Southwest*.

Albuquerque: University of New Mexico Press, 2002.

Primarily a study the mid-20<sup>th</sup> century Santa Fe architect, John Gaw Meem, who was largely responsible for the revival of the Santa Fe style of architecture. The author, a fine historian and writer, goes beyond the superficiality of style and discusses Meem's skill at placing his buildings on their site in order to take full advantage of sun, natural ventilation and views, thus creating very pleasant and habitable spaces. The book contains many lovely photographs and well-drawn floor plans.

Wright, Gwendolyn. *Building the Dream: A Social History of Housing in America*.

Cambridge: MIT Press, 1983.

A history of the various neighborhoods and housing types found in the United States during the first two centuries. Beginning with the Puritan townscape to suburban sprawl, the author, an architectural historian, traces the design of American houses and their relationship to the society and technology of their time.

## periodicals, articles and essays

---

Brittain, Richard G. and Matts A. Myhrman. "Toward a Responsive Tohono O'odham Dwelling."

*Arid Lands Newsletter*, vol. 28 (Spring/Summer 1989), pp. 20-23.

An interesting article describing the process used, by two Anglo designer-builders, in their successful attempt to build for Native Americans. Sensitivity to the Tohono O'odham Indian's building preferences led to a successful reservation building. Although not a residence, but a meeting place, the process still offers instruction on the art of building for different cultures.

Jackson, J. B. "Chihuahua – As We Might Have Been." *Landscape* vol.1, no.1 (1951).

A classic article, by a cultural landscape historian, on how town planning was developing in the Southwest under Spain and Mexico and how settlement patterns changed after the area became a United States possession.

Jackson, J.B.. "First Comes the House." *Landscape* vol.9 no.2 (1959).

Another article by this dean of American cultural landscape interpreters. Here Jackson traces the development of the ordinary American house from its New England roots through its Western migration.

Parfit, Michael, et. al. "Emerging Mexico"

*National Geographic* (Special Issue) Volume 190, Number 2, August, 1996

Washington D.C., National Geographic Society

The entire issue is devoted to Mexico. Contains extensive articles on the border region, including Tijuana, Chihuahua and Monterrey. Features the characteristically excellent photographs for which NNG is rightly renowned. Very worthwhile.

Veregge, Nina. "Transformations of Spanish Urban Landscapes in the American Southwest, 1821 – 1900."

*Journal of the Southwest*. Volume 35, Number 4, (Winter 1993), pp.371 – 459.

Tucson, University of Arizona Press

An article derived from the author's master's thesis that discusses the urban transformations of several Southwestern towns, including Santa Fe, Tucson, Albuquerque, as well as Socorro and Las Vegas, New Mexico. Academic in form, but interesting as a study of evolving southwest urban patterns. Well illustrated with maps and vintage photographs.

## reports and studies

---

Garrison, James W. & Ruffner, Elizabeth F. Editors. *Adobe: Practical And Technical Aspects of Adobe Conservation*.

Phoenix: Heritage Foundation of Arizona, 1983.

A useful collection of articles, by various authors, on subjects pertaining to understanding the inherent characteristics and preservation techniques of adobe structures. Might be difficult to locate other than in libraries.

Pratt, Boyd C. and Chris Wilson. "The Architecture and Cultural Landscape of North Central New Mexico: Field Guide for the Twelfth Annual Vernacular Architecture Forum, Santa Fe, New Mexico," 1991.

This is a limited edition guide produced for a conference on vernacular architecture that was held in Santa Fe. While probably difficult to locate, and with copy machine quality illustrations, it does contain informative articles on the architecture of northern New Mexico and is a valuable information resource for northern New Mexico towns and architecture.

## CONTEMPORARY APPLICATIONS

---

### books

Alexander, Christopher, et. al. *A Pattern Language*.  
New York: Oxford University Press, 1977.

A remarkable book, by a team of University of California, Berkeley architects, that offers more than 250 patterns or precepts that can guide a planner or designer in the act of making towns down to the act of creating small architectural details. Easy to understand with hundreds of illustrations. An excellent guide for professionals and non-professionals alike.

Alexander, Christopher, et. al. *The Production of Houses*.  
New York: Oxford University Press, 1985.

The building of a small housing complex in Mexicali, Mexico, utilizing the principles described in the publication above, and involving the future occupants in the planning and construction of their own dwellings, is chronicled in this interesting and illustrated publication. A process of design and construction that is slowly developing in the United States with such programs as Habitat for Humanity, The Rural Studio (see: Oppenheimer) and other self-help type projects.

Arief, Allison and Burkhart, Bryan. *Pre Fab*.  
Layton, Utah: Gibbs Smith Publisher, 2002.

A rich visual survey, with text, of recent prefabricated houses that will shatter the perception that this type of housing has to look cheap and feel inferior. Shows wonderful solutions to the manufactured house by architects from all over the globe. This could be a valid solution to housing shortages world wide, as well as the American Southwest. (see: Winter)

Arreola, Daniel D. and Curtis, James R. *The Mexican Border Cities: Landscape Anatomy and Place Personality*.  
Tucson: University of Arizona Press, 1993.

An examination of cities and towns along the U.S.-Mexican border, showing that despite their presence in, or their proximity to, the United States, these communities are fundamentally Mexican places. While it could be augured that they are really hybrid places, both American and Latin, it is still necessary for any architect or builder working in the Borderlands to understand this unique population. The information in this publication will advance that knowledge.

Benyus, Janine M. *Biomimicry: Innovation Inspired by Nature*.  
New York: Perennial, 1998.

An inspirational book which challenges designers to tap into Nature's intelligence as guidance in the creation process and also profiles innovative bio-inspired research.



Georges, Danielle and Andrea Keenan, ed. *Green Building: Project Planning and Cost Estimating*  
Kingston, MA: RS Means Construction Publishers & Consultants, 2002.

A reference guide for the construction of sustainable buildings providing cost data for green materials, components, and systems, special project requirements, and financial analysis and incentives.

Chermayeff, Serge and Alexander, Christopher. *Community and Privacy: Toward a New Architecture of Humanism*  
New York: Doubleday & Company, 1963.

An interesting and relevant study of the benefits of zoned spaces in residential architecture. Excellent, illustrated examples of domestic floor plans that succeed in providing social space or private space when needed, as well as those plans that fail in this respect.

Clark, Sam. *The Real Goods Independent Builder*. White River Junction, Vermont: Chelsea Green Publishing, 1996.

Cofaigh, Eoin O., et. al. *The Climatic Dwelling*. London: James & James (Science Publishers) Ltd., 1996.

Developed for the Directorate General XII for Science, Research, and Development of the European Commission, this study documents climate-responsive residential architecture. Historical and modern Case studies spotlight urban European approaches to sustainable and efficient housing.

Duany, Andres; Plater-Zyberk, Elizabeth, and Speck, Jeff. *Suburban Nation: The Rise of Sprawl and the Decline of the American Dream*.  
New York: North Point Press, 2001.

As the title suggests this is another critique of the endemic suburban sprawl that plagues the U.S. and is now spreading to other countries. Two of the authors, Duany and Platter-Zyberg have been pivotal architects of the New Urbanism approach to town and community planning (see: Jacobs, Katz and Leccese). Developers and homebuyers should seriously consider their proposals for alternative approaches to land development based on pre-automobile communities alike.

Duffield, Mary Rose and Warren Jones. *Plants for Dry Climates*. Cambridge, Massachusetts: Perseus Publishing, 2001.

A technical listing and description for hundreds of plants suited for arid climates. Includes methods for creating Micro climates and landscaping themes to save energy, increase comfort levels and self-maintaining areas around a building.

Easton, David. *The Rammed Earth House*.

White River Junction, Vermont: Chelsea Green Publishing Company, 1996.

A beginning primer on an increasingly popular form of earthen construction where moistened soil and cement are compressed into wooden or steel forms, thus resulting in thick, high thermal mass walls. A good introduction, but not thorough enough to serve as a complete construction guide. However, there is not much else available – a condition that will probably soon change.

Fathy, Hassan. *Natural Energy and Vernacular Architecture: Principles and Examples with Reference to Hot Arid Climates*  
Chicago: University of Chicago Press, 1986.

Drawing heavily from traditional architecture of the Middle East, the author, a renowned Egyptian architect demonstrates the advantages of vernacular building techniques for a hot arid climate. Fathy states a case for architectural forms and materials that have evolved intuitively but are scientifically valid. An excellent guide to passive cooling and natural ventilation strategies. (see: Steele)

Farrelly, E. M. *Three Houses: Glen Murcutt*  
London: Phaidon Press Ltd., 1993, reprinted 2002.

These three houses, well illustrated with photographs and detailed drawings, are in Australia, not the U.S. Southwest; however, the type of architecture presented would definitely be suited for any arid terrain. A different and more industrialized approach to domestic architecture.

Golany, Gideon S. editor. *Design for Arid Regions*.  
New York: Van Nostrand Reinhold Company, 1983.

An excellent reference book that integrates ancient arid lands building practices with contemporary requirements. Draws heavily from North African and Middle-Eastern experience, and offers guidance on ways of developing an architecture for a hot, arid climate

Golub, Jennifer. *Albert Frey: Houses 1 and 2*.  
New York: Princeton Architectural Press, 1999.

Frey, a Swiss trained architect, came out to the California desert during the 1930s and built some remarkable houses, for himself and others, utilizing industrialized materials that can withstand the intense sun. This book ventures into considerable detail concerning two houses that he built for his own use. "House One" is an excellent example of ways to maximize a small amount of enclosed square footage. A good lesson in conserving material resources.

Hayden, Dolores. *Redesigning the American Dream*.  
New York: W.W. Norton & Co., 1984, revised 2002.

A critique of current suburban domestic housing from a gender perspective. An excellent discussion of how, as the occupants of houses have changed to two income producing adults and single parents, most housing form has not adequately evolved to accommodate this new family structure. The author offers recommendations for new housing and settlement patterns that reflect these relatively new sociological conditions.

Houben, Hugo and Guillaud, Hubert. *Earth Construction: A Comprehensive Guide*.  
London: Intermediate Technology Publications, 1994.

Almost everything that one needs to know about a traditional approach to building with earth is contained in this book. Chapters range from the chemical analysis of soil to finishes and decoration. A British publication, so it might be difficult to readily obtain, but well worth the search.

Jacobson, Max et al. *Patterns of Home: The Ten Essentials of Enduring Design*. Newtown, CT: The Taunton Press, 2002.

A clearly written and richly illustrated book by three architects, who had previously contributed to *The Pattern Language* (see Alexander) that presents some of the essential issues that contribute to the creating of a well-crafted and habitable house. An excellent planning guide for anyone desiring to design and build a comfortable and inspiring dwelling.

Jones, Tom, et. al., eds. *Good Neighbors: Affordable Family Housing*. Melbourne: The Images Publishing Group Pty Ltd. 1997.

While not specifically limited to the Southwest, this collection of case studies of multi-family houses offers interesting concepts on site planning, material use and various American styles. Most examples are of affordable housing and include a great variety of possible approaches. Does include several examples from Arizona and Texas.

Katz, Peter. *The New Urbanism: Toward an Architecture of Community*. New York: McGraw-Hill, 1994.

For anyone interested in understanding the goals of The New Urbanism movement (see: Duany, Leccese), this book is an excellent introduction. Well illustrated with numerous examples, many unbuilt at the time of publication, of projects by architects who subscribe to this type of community planning. Less a guide to individual buildings than an indication of what new housing and mixed use developments could be like.

Kennedy, Joseph F., et. al., eds. *The Art of Natural Building*. British Columbia: New Society Publishers, 2002.

A collection of articles by authors writing on their choice of “natural” building technique. Topics range from popular traditional methods, such as stone masonry, timber framing, straw bale and earthen construction, to more specialties as earthbag-papercrete, cob, as well as a section on permaculture. A good survey and introduction to different construction possibilities.

King, Bruce. *Buildings of Earth and Straw*. Sausalito, California: Ecological Design Press, 1996.

A structural design guide for buildings made of straw and earth. A lighthearted approach to a complicated topic, King breaks down the analysis of structural forces and calculations of natural buildings to an understandable level, based on modern and historical building techniques.

Kunstler, James Howard. *The Geography of Nowhere: The Rise and Decline of America's Man-Made Landscape*. New York: Simon and Schuster, 1993.

An indictment of the generic landscape of strip shopping centers, vast parking lots, and giant housing tracts. The author proposes remedies for such desolated conditions by having us return to more traditional planning principles, such as those espoused by proponents of the New Urbanism. (See Duany, Katz, and Leccese).

Lacinski, Paul and Michael Bergeron. *Serious Straw Bale: A Home Construction Guide for All Climates*. White River Junction, Vermont: Chelsea Green Publishing, 2000.

A historic and technical approach to how straw bale construction is affected by humidity and temperature. Regional approaches to natural building materials and construction methods.

Leccese, Michael and McCormick, Kathleen, editors. *Charter of the New Urbanism*.

New York: McGraw-Hill, 2000.

With essays and case studies, the editors demonstrate how cities might be revived, suburbs improved and traffic congestion reduced, all by smarter planning based on the New Urbanism principles. (see: Duany & Katz) More of a planning guide, but does include some recommended and salient architectural features.

LeMone, Katia and Dr. Owen Geiger. *Builders Without Borders Straw-Bale Construction Facilitators Guide*. Without Borders, 2004

MacDonald, S.O. and Matts Myhrman. *Build it with Bales: A Step-by-Step Guide to Straw-Bale Construction Version Two*. Tucson, Arizona: Out On Bale, 2004.

A step-by-step guide on how to build and finish a straw bale building. Filled with illustrations, easy to understand descriptions, and advice on all aspects of building with straw.

Magwood, Chris and Chris Walker. *Straw Bale Details*. Gabriola Island, British Columbia: New Society Publishers, 2001

A catalog of material testing, building code information and construction details for the floor, walls and roof of straw bale structures.

Moore, Charles; Allen, Gerald and Lyndon, Donlyn. *The Place of Houses*.

New York: Holt, Rinehart and Winston, 1974.

A classic by three architects who describe through historical examples and their own work how to make houses that are delightful, livable and site specific. Another indispensable addition, along with *The Pattern Language* (see: Alexander), to the library of any house designer.

Moore, Fuller. *Environmental Control Systems: Heating Cooling Lighting*. McGraw Hill, Inc., 1993.

Introduces and explains, passive solar heating, passive cooling and day lighting strategies in commercial and residential buildings. A great analytical text for understanding site planning and design related to the sun, wind and building materials.

Mostaedi, Arian. *Sustainable Architecture, Low Tech Houses*.

Barcelona: Charles Broto & Joseph M. Minguet, no date.

A wonderful and well-illustrated collection of housing, constructed from natural materials, from the U.S., Europe and Japan. Unorthodox materials, such as paper, sandbags, as well as rammed earth and adobe, are used in beautiful ways. A very inspirational book.

Myhrman, Matts and MacDonald, S.O. *Build it with Bales: A Step-by-Step Guide to Straw-Bale Construction*. Tucson, Arizona: published by authors, 1997.

A guide to the construction of straw bale houses by two pioneers of this recently revived and popular building method. The authors are constantly experimenting and attempt to bring readers up to date by issuing revised editions.

Neutra, Richard. *Survival Through Design*. New York: Oxford University Press, 1969 reprint.

The author, a pioneer in contemporary architecture, presents his approach to the problem of man's survival in an often chaotic and technological environment. He directs us to study basic and organic responses in order to discover the principles for designing vital spaces. This book is as valid today as it was when first published in 1954.

Oppenheimer, Andrea Dean. *Rural Studio: Samuel Mockbee and an Architecture of Decency*. New York: Princeton Architectural Press, 2002.

This book chronicles a remarkable program, in Auburn University's architecture school, where students and faculty live in poor southern communities while designing and constructing houses and other buildings for people who could never afford a well designed house, much less the service of an architect. While not set in the Southwest, many subsistence borderland communities could benefit from similar programs in their areas.

Pijawka, K. David and Shetter, Kim. *The Environment Comes Home: Arizona Public Service's Environmental Showcase House*.

Tempe: Herberger Center for Design Excellence, College of Architecture and Environmental Design, Arizona State University, 1995.

A generously illustrated, bound report on a model energy responsive home built in the Phoenix, Arizona area, with modern materials, during the middle 1990s. Contains excellent preliminary information on design strategies, and lists environmentally responsible building materials and products, as well mechanical/plumbing systems. A good primer for all aspects of house design with specific attention to a hot, arid region.

Roberts, Carolyn. *House of Straw: A Natural Building Odyssey*. White River Junction, Vermont: Chelsea Green Publishing, 2002.

A narrative of all the rewards, hard work and joy that can result from building a straw bale house oneself. Experiences range from choosing the land, designing and building the house to habitation.

Shelter Publications *Shelter*  
Berkeley: Ten Speed Press, 1973 and 1990

A catalogue of "...a wide range of information on hand-built housing and the building crafts." A comprehensive hippie's guide to vernacular architecture, quite outstanding and very much of its idealistic time.

Smith, Peter F. *Sustainability at the Cutting Edge*  
Oxford & New York: Architectural Press, 2003.

The author describes how buildings can be made to significantly reduce their reliance on fossil-based energy by the use of solar, hydro and geothermal resources. Somewhat technical, but still relevant and stimulating.

Stein, Benjamin and John S. Reynolds. *Mechanical and Electrical Equipment for Buildings*. New York: John Wiley and Sons, Inc., 1992.  
A comprehensive reference book on both active and passive strategies for heating, cooling and lighting systems.

Steen, Athena Swentzell, et al. *The Straw Bale House*. White River Junction, Vermont: Chelsea Green Publishing, 2004.  
This is a diverse study of straw bale history, design and construction. Case Studies and detailed illustrations provide valuable information for the owner-builder as well as the design and construction professional.

Steele, James. *An Architecture for People*.  
New York: Whitney Library of Design, 1997.  
A critical view of the Egyptian architect Hassan Fathy and his life long quest to build earthen structures that employ natural principles of ventilation, heating and cooling. Fathy's architecture displays a high concern for sustainability, energy conservation and the responsible use of natural resources. A study of his work will offer relevant ideas for any arid lands architecture. (see: Fathy)

Tibbets, Joseph M. *The Earth Builders' Encyclopedia*.  
New Mexico: Southwest Solaradobe School, 1989.  
Almost everything one needs to know about earthen architecture with a special emphasis on the Southwest United States. With clear text and the author's enjoyable illustrations, covers topics from "Ablowbe" (a type of blown-on mud plastering system) to Zoquete (slang term for adobe mud). The current edition is only available on CD ROM.

Uviña, Francisco. *Adobe Architecture Conservation Handbook*.  
Santa Fe: Cornerstones Community Partnerships, 1998.  
More of a restoration manual, but a great book by an extremely knowledgeable author who is a mainstay in a very valuable community service organization in New Mexico. This publication might serve as a repair guide if you were to build with adobe in a traditional manner.

Wade, Alex & Ewenstein, Neal. *30 Energy-Efficient Houses You Can Build*.  
Emmaus: Rodale Press, 1977.  
A bit dated but still relevant, this publication shows examples of relatively small houses that exploit natural energy sources, such as solar by proper siting and choice of materials. Example structures will bring back memories for those of you who remember the energy crisis of the middle 1970s and the subsequent architectural responses.

Weisman, Alan. *La Frontera: The United States Border with Mexico*  
Tucson: University of Arizona Press, 1991 (2<sup>nd</sup> Edition).  
The first edition of this book is almost two decades old, but the content is as relevant now as it was at the time of first publication. Not a building guide in any way, but an excellent journalistic report on borderlands social and environmental dynamics.

Wright, Frank Lloyd. *The Natural House*.

New York: Horizon Press, 1963.

Another old-timer, but still quite relevant. If the millions of production houses had followed just a few of the master's recommendation, we would have much better housing stock throughout North America. Recommended for anyone building or searching for a house.

## periodicals, articles and essays

---

Curtis, Wayne. "Material Gains: ...the Search for Enduring Things (Materials with which) to Build."

*Preservation*. January / February, (2001), p.28.

The author presents a historical view of building materials, from wood to plastic, with an assessment of their relative values and shortcomings. Contains an interesting discussion on new composite materials, such as decay resistant lumber made from waste wood and recycled plastic, as well as other recently developed products.

Roberts, Carolyn. "The House That Built Me."

*Natural Home*. July, (2004), pgs. 80-81

Steen, Athena and Bill. "Building With Straw Bales"

*Mother Earth News*. January, (1996), pgs. 40-47.

## reports and studies

---

Chalfoun, Nader V. Ph.D & Richard J. Michal P.E. "Thermal Performance Comparison of Alternative Building Envelope Systems: An Analysis of Five Residences in the Community of CIVANO." University of Arizona College of Architecture, Planning and Landscape Architecture. (2003), pgs. 1-5

Hardin, Mary. "Appropriate Technology: Cycling Between High and Low Tech in the Sonoran Desert." University of Arizona College of Architecture, Planning & Landscape Architecture. (2002), pgs. 1-5

Land, Peter. *Economic Garden Houses: High Density Development*.

Chicago: College of Architecture, Planning and Design, Illinois Institute of Technology. 1977.

Report of a design research studio conducted by the outstanding British architect Peter Land with his students at IIT. The focus is high density/low-rise housing with courtyards as the principal outdoor space. Contains examples of one-level, two-level and split-level models that could be applied the southwestern U.S. This publication is rare, and is likely only available through university libraries. It should without doubt be republished in an expanded and updated format.

Land, Peter. *Economic Housing: High Density, Low Rise, Expandable Unit design, building technology, urban structure*  
Champagne-Urbana: Department of Architecture, University of Illinois. 1975.

Results of a design studio conducted by Land while a visiting professor at the University of Illinois. The projects are set in Peru and are a continuation of the author's work with the Programa Experimental de Vivienda (PREVI) in Lima in the early 1970s. The design program required an affordable housing system that could evolve as families grew and changed, while preserving private outdoor space through courtyards and roof terraces. A rigorous approach to design of low-cost housing with an awareness of the importance of urban form.

US/ICOMOS. *6th International Conference on the Conservation of Earthen Architecture.*

Los Angeles: The Getty Conservation Institute. 1990.

The proceedings from a multi-national conference held in Las Cruces, New Mexico, in 1990. Contains many informative papers, each in the language of the author, with Spanish and English, as one would expect, dominating. Many of the articles are highly technical and geographically varied, but not without value.

Vint, Robert. *Architectural Concept Study: Housing Design for San Xavier.* Tucson: San Xavier District of the Tohono O'odham Nation. 1993.

Report on culturally and climatically appropriate housing designs for the Tohono O'odham Native Americans of Southern Arizona. Includes prototypical designs for desert dwellings.

Winter, Steven and Associates. *A Community Guide to Factory-Built Housing.* U.S. Department of Housing and Urban Development. 2001.

A recent report on the potential and utilization of prefab housing units. Not specific to the Southwest United States and the architectural aspirations of models shown are only slightly above par, but could be used as a supplement to *PreFab* (see: Arieff).

"R-Value of Straw Bales Lower than Previously Reported." EBN Volume 7 No. 9, October 1998

Builders Without Borders "Straw-Bale, Low Income Houseing Workshop- Anapra, Mexico"

<http://www.builderswithoutborders.org> 2003

U.S. Department of Energy. "House of Straw: Straw Bale Construction Comes of Age." <http://www.eere.energy.gov> July 2004



# APPENDIX

## thermal performance research data

*about CalPas3, energy and thermal modeling software:*

CalPas is considered one of the most sophisticated energy design/simulation programs for residential and small commercial buildings. It is a useful design tool with a full 8760-hour simulation for predicting the energy performance. It calculates hourly air, surface, and mass temperatures throughout the building, as well as heat transfer among components, the contribution of natural energy to comfort levels, and the mechanical heating or cooling needed to maintain temperatures specified by the designer. The program will model the heating and cooling loads, as well as the exact values of transmittance for each window. Infiltration rates can vary with wind of one-zone or two-zone buildings, with air and storage temperatures (at up to 38 nodes), heat gains and losses, and all heat transfer within the building. Incident solar radiation on each surface is calculated in details, as well as the exact values of transmittance for each window. Infiltration rates can vary with wind speed and indoor-to-outdoor temperature differences. Conduction from a slab or rock bed to an approximate ground temperature is also calculated. You can model any wall or window orientation or type, forced or natural convection between zones, and seasonally and monthly variable shading from shutters, overhangs, and side fins. Ground reflectance can also be specified monthly for each glazing section to represent a horizontal reflector or some special condition. Additionally, movable window insulation, thermal and wind-driven natural convection for cooling (with reduction to account for wind direction), and forced ventilation and evaporative cooling.

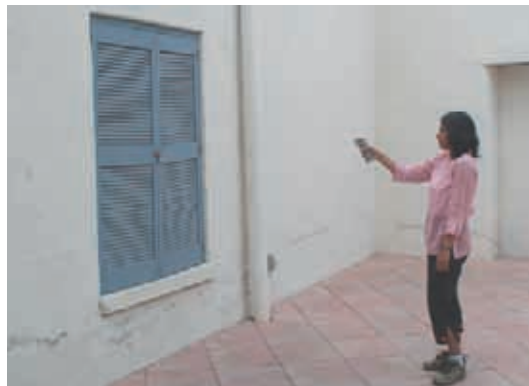

*(l.) Radbika measures surface temperatures of north facade of Fish House east courtyard using a non-contact infra-red thermal gun. Photo: C. Neumann*

*(r.) Christina measures surface reflectance of unpaved portions of Fish House east courtyard using a Li-Cor pyrometer. Photo: Radbika Murthy*

## FIELD MEASUREMENTS

In order to enter the most accurate site data into CalPas 3 for this evaluation of vernacular structures, detailed site information was collected at the case study locations. Measurements were taken at various points on all walls of the building and on the ground surrounding the buildings. Surface temperatures and reflectance were measured in both sun and shade.



*Fish House west facade. Photo: C. Neumann*

### 3.23.04 FIELD MEASUREMENTS

FISH STEVENS DUFFIELD HOUSE, MULTICELL HISTORIC ADOBE : TUCSON ARIZONA

#### WEATHER CONDITIONS

|                           |              |      |                      |      |     |
|---------------------------|--------------|------|----------------------|------|-----|
| <b>Time</b>               | 11:00 -13:30 |      | <b>Dew Point (F)</b> | 46.4 |     |
| <b>Temperature (F)</b>    | Mean         | 76   | <b>Humidity</b>      | Mean | 40  |
|                           | High         | 86   |                      | High | 58  |
|                           | Low          | 66   |                      | Low  | 21  |
| <b>Precipitation (in)</b> | 3.23.04      | 0    | <b>Wind (mph)</b>    | Mean | 9.8 |
|                           | M.T.D.       | 0.73 |                      | Max  | 15  |
|                           | Y.T.D.       | 1.97 |                      | Gust | 18  |

#### SITE CONDITIONS

##### Tree Details

|                  | x-coord | y-coord | height | diameter | canopy   | foliage |
|------------------|---------|---------|--------|----------|----------|---------|
| Tree 1 (T1) east | 15'-2"  | 1'-6"   | 25'    | 24'      | 6' - 25' | med.    |
| Tree 2 (T2) east | 34'     | 4'-9"   | 17'    | 15'      | 3' - 17' | dense   |
| Tree 3 (T3) east | 46'     | 11'-4"  | 45'    | 38'      | 7' - 45' | dense   |
| Tree 4 (T4) west | 8'-11"  | 48"     | 14'    | 9'       | 5' - 14' | med.    |
| Tree 5 (T5) west | 7'-6"   | 45'-5"  | 40'    | 30'      | 8'- 40'  | dense   |
| Tree 6 (T6) west | 7'-8"   | 74'-5"  | 25'    | 17'      | 7'-17'   | med.    |

##### Temperature (F)

###### East

|               |    |                      |     |
|---------------|----|----------------------|-----|
| T1 (east)     | 82 | T1 Paving (shade)    | 100 |
| T2 (east)     | 89 | T1 Paving (sun)      | 104 |
| T3 (east)     | 87 | T2 Foliage in sun    | 96  |
| wall (shade)  | 85 | door/win. (shade)    | 104 |
| wall (sun)    | 86 | door/win. (sun)      | 92  |
| conc. (shade) | 85 | gravel/ dirt (shade) | 89  |
| conc. (sun)   | 97 | gravel/ dirt (sun)   | 103 |

##### Reflectance (btu/ft<sup>2</sup> hr)

|                        | air    | material | a/m  |                      | air    | material | a/m  |
|------------------------|--------|----------|------|----------------------|--------|----------|------|
| dirt (shade around T3) | 361.6  | 55.5     | 0.15 | conc. paving (shade) | 352.1  | 57.1     | 0.16 |
| dirt (sun around T3)   | 1268.8 | 57.1     | 0.05 | conc. paving (sun)   | 1459.1 | 269.1    | 0.18 |
| north wall (shade)     | 285.5  | 158.6    | 0.56 | north window (shade) | 285.5  | 22.8     | 0.08 |
| west wall (shade)      | 142.5  | 63.4     | 0.46 | west window (shade)  | 149    | 79.3     | 0.53 |
| west wall (sun)        | 571    | 257      | 0.45 | west window (sun)    | 504.4  | 19       | 0.04 |
| red brick paver (sun)  | 951.6  | 190.3    | 0.2  |                      |        |          |      |

# CALPAS 3 GLOSSARY

## CALPAS 3 USER MANUAL Notes, Monthly House Energy Balance

**Units and Sign Convention.** All values are in kBtu/month. Positive values indicate energy entering the conditioned space. Negative values indicate energy leaving the conditioned space (and going to the outside, or into the storage). Using this convention, all the energy transfers for a unit of time sum to 0.

**COND.** The energy lost from or gained by the conditioned space due to conduction in kBtu/month. This value includes all transfers through walls and glazing and conduction to the outside of mass elements EXCEPT conduction from the sunspace via UATAHS (on the SSCOUPLING command) and transfer from inside of the sunspace masswall.

**SHCOND.** The energy lost or gained by the conditioned space via conduction to or from the sunspace, in kBtu/month. The value here is the sum of conduction due to UATAHS coupling specified on the SSCOUPLING command and transfer from the inside of the sunspace masswall. See also MH8.

**INFIL.** Energy transfer to or from the conditioned space due to infiltration in kBtu/month.

**SLR.** Total solar gain to conditioned space after the effect of any shutters, shading, solar gain factors, or other gain modifiers; in kBtu/month.

**INT.** Energy added to the conditioned space by internal gains, in kBtu/month. These gains are specified on the INTGAIN command.

**STRG.** The net heat gained by or lost from all the house storage combined (masswall, slab, intwall, exwall, rockbed, and house air node); in kBtu/month. Over a period of a month, this value is normally relatively small since average mass temperatures usually do not vary greatly.

**RB+SS.** The sum of the transfer from the rockbed to the house and the transfer from the sunspace to the house, in kBtu/month. These values have been combined to save space on the report.

**VENT.** Energy removed from conditioned space with outside air ventilation, in kBtu/month.

**COOL.** Energy removed from the conditioned space by the heating system, in kBtu/month.

**HEAT.** Energy added to the conditioned space by the heating system, in kBtu/month.

**THL, THH, THM.** House air temperatures, in degrees Fahrenheit.

- THL** (temperature house low) is the monthly mean of daily minimum house air temperatures
- THH** (temperature house high) is the monthly mean of daily maximum house air temperatures
- THM** (temperature house mean) is the monthly mean of daily house air temperatures

These values show the typical swing of the house air temperature which is useful for assessing comfort conditions, mass effectiveness, and so on.

**TSL, TSH, TSM.** Sunspace air temperatures, degrees Fahrenheit. Analogous to house temperatures THL, THH, THM.

**DBL, DBH, DBM.** Outside dry bulb temperatures from the weather file, degrees Fahrenheit. Analogous to house air temperatures THL, THH, THM.

**SGL.** Mean daily total solar radiation on a horizontal surface (global) from the weather file, Btu/sf.

**PEAKS.** Peak hourly energy transfers, in kBtu/h, and the day of the month on which each occurred.

- HSCL** is the house cooling hourly peak for the month.
- HSHT** is the house heating hourly peak for the month.
- SSCL** is the sunspace cooling hourly peak for the month.
- SSHT** is the sunspace heating hourly peak for the month.

# TUCSON WEATHER TMY1 DATA FILE

File Created By: NADER CHALFOUN Date: APRIL 29, 1991

1. City Name: TUCSON 2. Country Name: USA

3. Latitude [deg]: 32.20 4. Hemisphere: NORTHERN

5. Longitude [deg]: 111.00 6. Elevation [ft]: 2584.00

7. Monthly Average Atmospheric Pressure [in. Hg]: JAN= 27.40 FEB= 27.40  
MAR= 27.33 APR= 27.27 MAY= 27.24 JUN= 27.25 JUL= 27.31 AUG= 27.35  
SEP= 27.32 OCT= 27.36 NOV= 27.38 DEC= 27.39

8. Monthly Average Hourly Solar Radiation on Hz Surface [BTU/ft<sup>2</sup>]:

|    | JAN  | FEB   | MAR   | APR   | MAY   | JUN   | JUL   | AUG   | SEP   | OCT  | NOV  | DEC  |
|----|------|-------|-------|-------|-------|-------|-------|-------|-------|------|------|------|
| av | 74.9 | 103.6 | 128.3 | 107.5 | 167.7 | 160.8 | 146.5 | 127.1 | 123.1 | 97.1 | 74.0 | 49.9 |

9. Monthly Average Hourly Dry Bulb Temperatures [°F]:

|    | JAN  | FEB  | MAR  | APR  | MAY  | JUN  | JUL  | AUG  | SEP  | OCT  | NOV  | DEC  |
|----|------|------|------|------|------|------|------|------|------|------|------|------|
| av | 50.3 | 40.2 | 43.3 | 58.0 | 75.4 | 89.1 | 85.0 | 82.7 | 81.0 | 65.7 | 62.3 | 54.3 |

10. Monthly Average Hourly Wet Bulb Temperatures [°F]:

|    | JAN  | FEB  | MAR  | APR  | MAY  | JUN  | JUL  | AUG  | SEP  | OCT  | NOV  | DEC  |
|----|------|------|------|------|------|------|------|------|------|------|------|------|
| av | 42.0 | 29.5 | 30.7 | 47.0 | 51.0 | 59.4 | 71.7 | 69.5 | 59.0 | 52.4 | 50.3 | 42.7 |

11. Monthly Average Hourly Relative Humidities [%]:

|    | JAN  | FEB  | MAR  | APR  | MAY  | JUN  | JUL  | AUG  | SEP  | OCT  | NOV  | DEC  |
|----|------|------|------|------|------|------|------|------|------|------|------|------|
| av | 55.1 | 28.6 | 19.6 | 49.3 | 17.9 | 17.0 | 55.6 | 55.5 | 29.5 | 48.6 | 47.1 | 41.1 |

12. Monthly Average Hourly Surface Wind Speeds [mph]:

|    | JAN | FEB | MAR | APR | MAY | JUN  | JUL  | AUG | SEP | OCT | NOV | DEC |
|----|-----|-----|-----|-----|-----|------|------|-----|-----|-----|-----|-----|
| av | 5.6 | 4.6 | 7.7 | 9.2 | 8.7 | 10.6 | 10.2 | 7.3 | 8.5 | 8.1 | 9.0 | 5.4 |

13. Monthly Ave. Hourly Surface Wind Directions [° clockwise from North]:

|    | JAN   | FEB   | MAR   | APR   | MAY   | JUN   | JUL   | AUG   | SEP   | OCT   | NOV   | DEC   |
|----|-------|-------|-------|-------|-------|-------|-------|-------|-------|-------|-------|-------|
| av | 116.0 | 153.5 | 267.9 | 211.6 | 217.2 | 119.7 | 176.1 | 193.8 | 206.0 | 143.2 | 166.6 | 173.3 |

14. Monthly Average Hourly Diffuse Radiation on Hz Surface [BTU/ft<sup>2</sup>]:

|    | JAN | FEB  | MAR  | APR  | MAY  | JUN  | JUL  | AUG  | SEP  | OCT  | NOV | DEC  |
|----|-----|------|------|------|------|------|------|------|------|------|-----|------|
| av | 8.0 | 11.5 | 17.7 | 31.7 | 24.6 | 24.5 | 21.6 | 21.7 | 17.3 | 11.2 | 7.9 | 12.6 |

Note: This file is created using the MRT software, a program developed by Dr. N. V. Chalfoun at the Environmental Research Laboratory of the University of Arizona. Correct application and operation of "MRT" is the responsibility of the user. Data was generated from TMY (Typical Meteorological Year) file distributed with the CalPas3 energy simulation software. Actual temperature data may deviate from the one predicted by "HOURLY" due to approximation of values.

# SUMMARY OF INPUT

|  |  |                          |                      |
|--|--|--------------------------|----------------------|
| <b>CATEGORIES</b>                        | <b>MANUFACTURED TRAILER BASE CASE UNINSULATED</b>                                  |                          |                      |
|  |  |                          |                      |
| <b>SITE</b>                              | LAT=32 LONG=110<br>80d E OF 8  |                          |                      |
| <b>SIZE</b>                              | <b>DESCRIPTION</b>   | <b>BASE</b>              |                      |
|  | <b>OUTSIDE FILM COEFFICIENT</b>  | WINDSPEED 8.0 MPH        | 4.5                  |
| <b>INSULATION</b>                        | <b>WINDFACTOR</b>  | SEMI-ENCLOSED URBAN      | 0.5                  |
|  | <b>FLOOR AREA (sf)</b>   |                          | 1650.9               |
|  | <b>VOLUME (cf)</b>   | AVERAGE 8.75' CEILING    | 14722.7              |
|  | <b>SURFACE AREA WALLS (sf)</b>   | WOOD FRAME               | 1219.7               |
|  | <b>SURFACE AREA ROOF (sf)</b>  | GREY ASPHALT SHINGLE     | 1906.4               |
|  | <b>TOTAL SURFACE AREA (W+R)</b>  |                          | 3126.1               |
|  | <b>SURFACE TO VOLUME RATIO</b>   |                          | 17%                  |
|  | <b>INTERIOR MASS WALL (sf)</b>   |                          |                      |
| <b>INSULATION</b>                        | <b>ROOF R VALUE</b>  | UNINSULATED              | 0.17                 |
|  | <b>WALL R VALUE</b>  | UNINSULATED              | 0.27                 |
|  | <b>PERIMETER SLAB INSULATION</b>   | TJI HUNG ON STEM WALL    |                      |
| <b>FENESTRATION</b>                      | <b>SOUTH WINDOW AREA (sf)</b>  |                          | 55.2                 |
|  | <b>NORTH WINDOW AREA</b>   |                          | 45.1                 |
|  | <b>EAST WINDOW AREA</b>  |                          | 18.5                 |
|  | <b>WEST WINDOW AREA</b>  |                          | 13.5                 |
|  | <b>TOTAL WINDOW AREA</b>   |                          | 128.3                |
|  | <b>SOUTH WIN./ FLR. AREA RATIO</b>   |                          | 3.3%                 |
|  | <b>TOTAL WIN./FLR AREA RATIO</b>   |                          | 7.7%                 |
|  | <b>DOUBLE GLAZED LOW-E</b>   |                          | NO                   |
|  | <b>WINDOW MATERIAL</b>   |                          | VINYL                |
|  | <b>REFLECTIVITY</b>  | <b>ROOF REFLECTIVITY</b> | GREY ASPHALT SHINGLE |
| <b>WALL REFLECTIVITY</b>                 |  | LT. BLUE VINYL SIDING    | 40%                  |
| <b>GROUND REFLECTIVITY (april-sept.)</b> |  | TYP. DESERT GROUND       | 32                   |
| <b>GROUND REFLECTIVITY (oct.-march)</b>  |  | TYP. DESERT GROUND       | 32                   |
| <b>BLOWER DOOR</b>                       | <b>INFILTRATION (AIR CHANGES/ HR.)</b>   | NEW HOUSE                | 9                    |
| <b>CONDITIONING</b>                      | <b>NATURAL VENTILATION</b>   |                          | YES                  |
|  | <b>HEATING &amp; COOLING SYSTEM</b>  | PASSIVE                  | NONE                 |

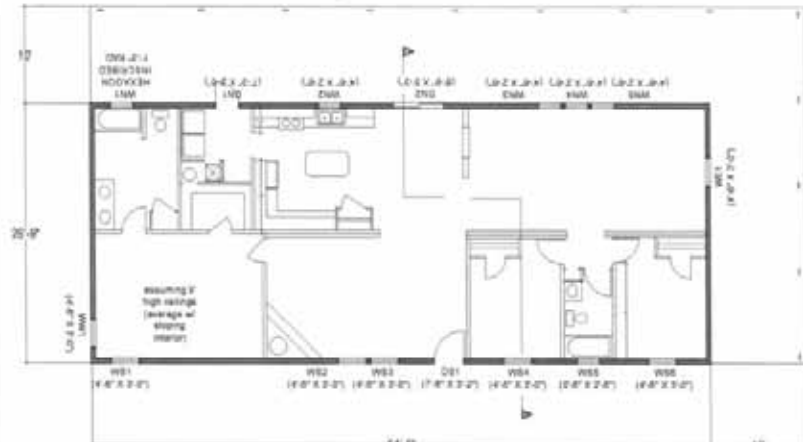

PLAN

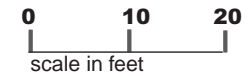

SOUTH ELEVATION



WEST ELEVATION



NORTH ELEVATION



EAST ELEVATION

**MANUFACTURED HOUSE INSULATED NO VENTILATION**

Run: C:\ALINNV.TXT 320 27-MAY-04 12:06:57 Page 1 of 10  
 MANUFACTURED INSUL NO VENT BY: NEUMANN CALPAS3 V3.12 License: PC0201

TUCSON, AZ Weather: TUCSON.AZ (Tucson AZ ETMY)

**MONTHLY HOUSE ENERGY BALANCE (kBtu; + into house)**

| MON | GAINS & LOSSES |       |         |        |        |       | TRANSFERS |      |      |      |
|-----|----------------|-------|---------|--------|--------|-------|-----------|------|------|------|
|     | COND           | SHCND | INFIL   | SLR    | INT    | STRG  | RB+SS     | VENT | COOL | HEAT |
| JAN | -1975.4        |       | -2294.2 | 2175.6 | 2116.1 | -22.0 |           |      | 0    | 0    |
| FEB | -1930.6        |       | -2371.4 | 2373.9 | 1911.3 | 16.8  |           |      | 0    | 0    |
| MAR | -2220.6        |       | -2944.1 | 3109.5 | 2116.1 | -60.8 |           |      | 0    | 0    |
| APR | -2182.8        |       | -3161.1 | 3350.6 | 2047.8 | -54.6 |           |      | 0    | 0    |
| MAY | -2161.1        |       | -3359.7 | 3422.8 | 2116.1 | -18.1 |           |      | 0    | 0    |
| JUN | -2023.0        |       | -3191.0 | 3188.2 | 2047.8 | -22.0 |           |      | 0    | 0    |
| JUL | -1983.9        |       | -2955.4 | 2752.3 | 2116.1 | 70.9  |           |      | 0    | 0    |
| AUG | -1934.3        |       | -2863.6 | 2751.5 | 2116.1 | -69.7 |           |      | 0    | 0    |
| SEP | -1942.1        |       | -2714.8 | 2562.7 | 2047.8 | 46.4  |           |      | 0    | 0    |
| OCT | -2057.4        |       | -2678.6 | 2600.1 | 2116.1 | 19.9  |           |      | 0    | 0    |
| NOV | -1993.6        |       | -2353.8 | 2210.0 | 2047.8 | 89.6  |           |      | 0    | 0    |
| DEC | -1952.4        |       | -2232.6 | 2047.4 | 2116.1 | 21.5  |           |      | 0    | 0    |
| TOT | -24357         |       | -33120  | 32545  | 24915  | 18.0  |           |      | 0    | 0    |

**MONTHLY CONDITIONS (Units as shown)**

| MON | TEMPERATURES (F) |     |     |     | WTHR (F; Btu/sf) |     |     |     | PEAKS (kBtuh) |      |         |         |         |         |
|-----|------------------|-----|-----|-----|------------------|-----|-----|-----|---------------|------|---------|---------|---------|---------|
|     | THL              | THH | THM | TSL | TSH              | TSM | DBL | DBH | DBM           | SGL  | HSCL/DY | HSHT/DY | SSCL/DY | SSHT/DY |
| JAN | 51               | 72  | 62  |     |                  |     | 41  | 63  | 51            | 1087 | 0       | 0       |         |         |
| FEB | 49               | 77  | 64  |     |                  |     | 38  | 66  | 52            | 1427 | 0       | 0       |         |         |
| MAR | 57               | 87  | 73  |     |                  |     | 45  | 74  | 60            | 1873 | 0       | 0       |         |         |
| APR | 65               | 96  | 82  |     |                  |     | 51  | 81  | 67            | 2389 | 0       | 0       |         |         |
| MAY | 72               | 102 | 89  |     |                  |     | 56  | 88  | 74            | 2692 | 0       | 0       |         |         |
| JUN | 84               | 112 | 100 |     |                  |     | 70  | 97  | 85            | 2720 | 0       | 0       |         |         |
| JUL | 86               | 110 | 99  |     |                  |     | 75  | 97  | 85            | 2309 | 0       | 0       |         |         |
| AUG | 84               | 108 | 97  |     |                  |     | 74  | 95  | 84            | 2185 | 0       | 0       |         |         |
| SEP | 80               | 103 | 92  |     |                  |     | 70  | 90  | 80            | 1963 | 0       | 0       |         |         |
| OCT | 68               | 94  | 82  |     |                  |     | 58  | 83  | 70            | 1634 | 0       | 0       |         |         |
| NOV | 57               | 80  | 69  |     |                  |     | 47  | 70  | 58            | 1207 | 0       | 0       |         |         |
| DEC | 50               | 72  | 62  |     |                  |     | 41  | 65  | 52            | 1014 | 0       | 0       |         |         |
| TOT | 67               | 93  | 81  |     |                  |     | 56  | 81  | 68            | 1877 | 0       | 0       |         |         |

**MANUFACTURED HOUSE INSULATED NATURAL VENTILATION**

Run: C:\ALINV.TXT 321 27-MAY-04 12:09:17 Page 1 of 10  
 MANUFACTURED INSUL NAT VENT BY: NEUMANN CALPAS3 V3.12 License: PC0201

TUCSON, AZ Weather: TUCSON.AZ (Tucson AZ ETMY)

**MONTHLY HOUSE ENERGY BALANCE (kBtu; + into house)**

| MON | GAINS & LOSSES |       |         |        |        |       | TRANSFERS |         |      |      |
|-----|----------------|-------|---------|--------|--------|-------|-----------|---------|------|------|
|     | COND           | SHCND | INFIL   | SLR    | INT    | STRG  | RB+SS     | VENT    | COOL | HEAT |
| JAN | -1844.5        |       | -2191.4 | 2178.7 | 2116.1 | -21.9 |           | -236.90 | 0    | 0    |
| FEB | -1566.7        |       | -2085.8 | 2378.2 | 1911.3 | 16.8  |           | -653.83 | 0    | 0    |
| MAR | -1057.3        |       | -2031.3 | 3124.3 | 2116.1 | -42.3 |           | -2109.6 | 0    | 0    |
| APR | -152.16        |       | -1567.7 | 3378.4 | 2047.8 | -17.8 |           | -3688.5 | 0    | 0    |
| MAY | 479.51         |       | -1287.7 | 3438.9 | 2116.1 | -31.3 |           | -4715.5 | 0    | 0    |
| JUN | 902.38         |       | -895.59 | 3188.2 | 2047.8 | -24.5 |           | -5218.3 | 0    | 0    |
| JUL | 735.37         |       | -821.81 | 2752.3 | 2116.1 | 50.1  |           | -4832.0 | 0    | 0    |
| AUG | 619.17         |       | -860.12 | 2751.5 | 2116.1 | -51.4 |           | -4575.2 | 0    | 0    |
| SEP | 451.36         |       | -836.82 | 2562.7 | 2047.8 | 44.8  |           | -4269.8 | 0    | 0    |
| OCT | -282.59        |       | -1286.0 | 2616.2 | 2116.1 | 14.4  |           | -3178.1 | 0    | 0    |
| NOV | -1405.5        |       | -1892.4 | 2217.4 | 2047.8 | 59.6  |           | -1027.0 | 0    | 0    |
| DEC | -1719.4        |       | -2049.8 | 2051.8 | 2116.1 | 21.5  |           | -420.17 | 0    | 0    |
| TOT | -4840.2        |       | -17806  | 32639  | 24915  | 18.0  |           | -34925  | 0    | 0    |

**MONTHLY CONDITIONS (Units as shown)**

| MON | TEMPERATURES (F) |     |     |     | WTHR (F; Btu/sf) |     |     |     | PEAKS (kBtuh) |      |         |         |         |         |
|-----|------------------|-----|-----|-----|------------------|-----|-----|-----|---------------|------|---------|---------|---------|---------|
|     | THL              | THH | THM | TSL | TSH              | TSM | DBL | DBH | DBM           | SGL  | HSCL/DY | HSHT/DY | SSCL/DY | SSHT/DY |
| JAN | 51               | 71  | 61  |     |                  |     | 41  | 63  | 51            | 1087 | 0       | 0       |         |         |
| FEB | 49               | 74  | 62  |     |                  |     | 38  | 66  | 52            | 1427 | 0       | 0       |         |         |
| MAR | 56               | 80  | 69  |     |                  |     | 45  | 74  | 60            | 1873 | 0       | 0       |         |         |
| APR | 62               | 85  | 74  |     |                  |     | 51  | 81  | 67            | 2389 | 0       | 0       |         |         |
| MAY | 66               | 92  | 80  |     |                  |     | 56  | 88  | 74            | 2692 | 0       | 0       |         |         |
| JUN | 74               | 101 | 89  |     |                  |     | 70  | 97  | 85            | 2720 | 0       | 0       |         |         |
| JUL | 78               | 101 | 89  |     |                  |     | 75  | 97  | 85            | 2309 | 0       | 0       |         |         |
| AUG | 76               | 99  | 88  |     |                  |     | 74  | 95  | 84            | 2185 | 0       | 0       |         |         |
| SEP | 73               | 94  | 84  |     |                  |     | 70  | 90  | 80            | 1963 | 0       | 0       |         |         |
| OCT | 65               | 87  | 76  |     |                  |     | 58  | 83  | 70            | 1634 | 0       | 0       |         |         |
| NOV | 56               | 76  | 67  |     |                  |     | 47  | 70  | 58            | 1207 | 0       | 0       |         |         |
| DEC | 50               | 71  | 61  |     |                  |     | 41  | 65  | 52            | 1014 | 0       | 0       |         |         |
| TOT | 63               | 86  | 75  |     |                  |     | 56  | 81  | 68            | 1877 | 0       | 0       |         |         |

Note: CALPAS3 is the property of and is licensed by Berkeley Solar Group, 3140 Martin Luther King Jr. Way, Berkeley, CA 94703 (415 843-7600). Correct application and operation of CALPAS3 is the responsibility of the user. Actual building performance may deviate from CALPAS3 predictions due to differences between actual and assumed weather, construction, or occupancy. CALPAS3 is certified for California energy code compliance when used in accordance with the BSG publication "Using CALPAS3 with the California Residential Building Standards."

**MANUFACTURED HOUSE NO INSULATION NO VENTING**

MANUFACTURED NO INSUL NO VENT BY: NEUMANN CALPAS3 V3.12 License: PC0201  
 TUCSON, AZ Weather: TUCSON.AZ (Tucson AZ ETMY)

MONTHLY HOUSE ENERGY BALANCE (kBtu; + into house)

| MON | GAINS & LOSSES |       |         |        |        | TRANSFERS |       |      |      |      |
|-----|----------------|-------|---------|--------|--------|-----------|-------|------|------|------|
|     | COND           | SHCND | INFIL   | SLR    | INT    | STRG      | RB+SS | VENT | COOL | HEAT |
| JAN | -2853.7        |       | -1431.3 | 2191.5 | 2116.1 | -22.6     |       |      | 0    | 0    |
| FEB | -2749.3        |       | -1561.3 | 2387.5 | 1911.3 | 11.8      |       |      | 0    | 0    |
| MAR | -3127.5        |       | -2076.6 | 3132.7 | 2116.1 | -44.6     |       |      | 0    | 0    |
| APR | -3020.8        |       | -2382.6 | 3406.5 | 2047.8 | -50.9     |       |      | 0    | 0    |
| MAY | -2926.1        |       | -2648.6 | 3483.4 | 2116.1 | -24.8     |       |      | 0    | 0    |
| JUN | -2698.6        |       | -2541.1 | 3219.3 | 2047.8 | -27.4     |       |      | 0    | 0    |
| JUL | -2675.3        |       | -2278.1 | 2779.3 | 2116.1 | 58.1      |       |      | 0    | 0    |
| AUG | -2645.9        |       | -2195.0 | 2778.2 | 2116.1 | -53.3     |       |      | 0    | 0    |
| SEP | -2682.7        |       | -1995.0 | 2588.0 | 2047.8 | 41.8      |       |      | 0    | 0    |
| OCT | -2931.8        |       | -1861.3 | 2647.5 | 2116.1 | 29.6      |       |      | 0    | 0    |
| NOV | -2864.0        |       | -1493.0 | 2227.2 | 2047.8 | 81.9      |       |      | 0    | 0    |
| DEC | -2830.0        |       | -1370.7 | 2061.7 | 2116.1 | 23.0      |       |      | 0    | 0    |
| TOT | -34006         |       | -23835  | 32903  | 24915  | 22.5      |       |      | 0    | 0    |

MONTHLY CONDITIONS (Units as shown)

| MON | TEMPERATURES (F) |     |     |     | WTHR (F; Btu/sf) |     |     |      | PEAKS (kBtuh) |         |         |         |
|-----|------------------|-----|-----|-----|------------------|-----|-----|------|---------------|---------|---------|---------|
|     | THL              | THH | THM | TSM | DBL              | DBH | DBM | SGL  | HSCL/DY       | HSHT/DY | SSCL/DY | SSHT/DY |
| JAN | 45               | 74  | 58  |     | 41               | 63  | 51  | 1087 | 0             | 0       |         |         |
| FEB | 42               | 80  | 60  |     | 38               | 66  | 52  | 1427 | 0             | 0       |         |         |
| MAR | 49               | 91  | 69  |     | 45               | 74  | 60  | 1873 | 0             | 0       |         |         |
| APR | 56               | 101 | 78  |     | 51               | 81  | 67  | 2389 | 0             | 0       |         |         |
| MAY | 62               | 108 | 86  |     | 56               | 88  | 74  | 2692 | 0             | 0       |         |         |
| JUN | 74               | 117 | 96  |     | 70               | 97  | 85  | 2720 | 0             | 0       |         |         |
| JUL | 79               | 115 | 96  |     | 75               | 97  | 85  | 2309 | 0             | 0       |         |         |
| AUG | 77               | 113 | 94  |     | 74               | 95  | 84  | 2185 | 0             | 0       |         |         |
| SEP | 73               | 108 | 89  |     | 70               | 90  | 80  | 1963 | 0             | 0       |         |         |
| OCT | 61               | 98  | 78  |     | 58               | 83  | 70  | 1634 | 0             | 0       |         |         |
| NOV | 50               | 82  | 65  |     | 47               | 70  | 58  | 1207 | 0             | 0       |         |         |
| DEC | 44               | 75  | 58  |     | 41               | 65  | 52  | 1014 | 0             | 0       |         |         |
| TOT | 59               | 97  | 77  |     | 56               | 81  | 68  | 1877 | 0             | 0       |         |         |

**MANUFACTURED HOUSE NO INSULATION NATURAL VENTILATION**

MANUFACTURED NO INSUL NAT VENT BY: NEUMANN CALPAS3 V3.12 License: PC0201  
 TUCSON, AZ Weather: TUCSON.AZ (Tucson AZ ETMY)

MONTHLY HOUSE ENERGY BALANCE (kBtu; + into house)



| MON | GAINS & LOSSES |       |         |        |        | TRANSFERS |       |         |      |      |
|-----|----------------|-------|---------|--------|--------|-----------|-------|---------|------|------|
|     | COND           | SHCND | INFIL   | SLR    | INT    | STRG      | RB+SS | VENT    | COOL | HEAT |
| JAN | -2320.1        |       | -1336.2 | 2197.1 | 2116.1 | -22.6     |       | -634.28 | 0    | 0    |
| FEB | -1491.9        |       | -1337.2 | 2394.0 | 1911.3 | 11.8      |       | -1487.8 | 0    | 0    |
| MAR | 48.532         |       | -1510.7 | 3141.6 | 2116.1 | -42.0     |       | -3753.5 | 0    | 0    |
| APR | 2128.4         |       | -1465.0 | 3412.2 | 2047.8 | -34.8     |       | -6088.6 | 0    | 0    |
| MAY | 3428.1         |       | -1516.4 | 3483.8 | 2116.1 | -31.5     |       | -7480.1 | 0    | 0    |
| JUN | 4349.3         |       | -1285.3 | 3219.3 | 2047.8 | -26.9     |       | -8304.2 | 0    | 0    |
| JUL | 3378.3         |       | -1199.4 | 2779.3 | 2116.1 | 48.4      |       | -7122.6 | 0    | 0    |
| AUG | 2948.3         |       | -1198.2 | 2778.2 | 2116.1 | -45.5     |       | -6598.9 | 0    | 0    |
| SEP | 2431.4         |       | -1083.7 | 2588.4 | 2047.8 | 41.5      |       | -6025.5 | 0    | 0    |
| OCT | 928.49         |       | -1173.5 | 2650.6 | 2116.1 | 23.0      |       | -4544.7 | 0    | 0    |
| NOV | -1401.2        |       | -1232.3 | 2232.4 | 2047.8 | 78.1      |       | -1724.9 | 0    | 0    |
| DEC | -2061.2        |       | -1233.7 | 2067.9 | 2116.1 | 23.0      |       | -912.10 | 0    | 0    |
| TOT | 12366          |       | -15572  | 32945  | 24915  | 22.5      |       | -54677  | 0    | 0    |

MONTHLY CONDITIONS (Units as shown)-

| MON | TEMPERATURES (F) |     |     |     | WTHR (F; Btu/sf) |     |     |      | PEAKS (kBtuh) |         |         |         |
|-----|------------------|-----|-----|-----|------------------|-----|-----|------|---------------|---------|---------|---------|
|     | THL              | THH | THM | TSM | DBL              | DBH | DBM | SGL  | HSCL/DY       | HSHT/DY | SSCL/DY | SSHT/DY |
| JAN | 45               | 73  | 57  |     | 41               | 63  | 51  | 1087 | 0             | 0       |         |         |
| FEB | 42               | 76  | 58  |     | 38               | 66  | 52  | 1427 | 0             | 0       |         |         |
| MAR | 49               | 84  | 66  |     | 45               | 74  | 60  | 1873 | 0             | 0       |         |         |
| APR | 56               | 91  | 74  |     | 51               | 81  | 67  | 2389 | 0             | 0       |         |         |
| MAY | 61               | 98  | 81  |     | 56               | 88  | 74  | 2692 | 0             | 0       |         |         |
| JUN | 73               | 107 | 91  |     | 70               | 97  | 85  | 2720 | 0             | 0       |         |         |
| JUL | 77               | 106 | 91  |     | 75               | 97  | 85  | 2309 | 0             | 0       |         |         |
| AUG | 75               | 105 | 89  |     | 74               | 95  | 84  | 2185 | 0             | 0       |         |         |
| SEP | 72               | 99  | 85  |     | 70               | 90  | 80  | 1963 | 0             | 0       |         |         |
| OCT | 61               | 91  | 75  |     | 58               | 83  | 70  | 1634 | 0             | 0       |         |         |
| NOV | 50               | 79  | 64  |     | 47               | 70  | 58  | 1207 | 0             | 0       |         |         |
| DEC | 44               | 72  | 57  |     | 41               | 65  | 52  | 1014 | 0             | 0       |         |         |
| TOT | 59               | 90  | 74  |     | 56               | 81  | 68  | 1877 | 0             | 0       |         |         |

Note: CALPAS3 is the property of and is licensed by Berkeley Solar Group, 3140 Martin Luther King Jr. Way, Berkeley, CA 94703 (415 843-7600). Correct application and operation of CALPAS3 is the responsibility of the user. Actual building performance may deviate from CALPAS3 predictions due to differences between actual and assumed weather, construction, or occupancy. CALPAS3 is certified for California energy code compliance when used in accordance with the BSG publication "Using CALPAS3 with the California Residential Building Standards."

## SUMMARY OF INPUT

|  |  |   |                                      |
|--|--|---|--------------------------------------|
| <b>CATEGORIES</b>                        | URBAN CASE #1 DUFFIELD HOUSE   |   |                                      |
|  |   |   |                                      |
| <b>SITE</b>                              | LAT=32 LONG=118<br>14d E OF S  |   |                                      |
|  | <b>DESCRIPTION</b>   |   | <b>BASE</b>                          |
| <b>SIZE</b>                              | <b>OUTSIDE FILM COEFFICIENT</b>  | WINDSPEED 7.5 MPH                             | 4.0                                  |
|  | <b>WINDFACTOR</b>  | SEMI-ENCLOSED URBAN                           | 0.5                                  |
| <b>SIZE</b>                              | <b>FLOOR AREA (sf)</b>   |   | 174.4                                |
|  | <b>VOLUME (cf)</b>   | AVERAGE 12' CEILING                           | 802.8                                |
|  | <b>SURFACE AREA WALLS (sf)</b>   | 22" ADOBE                                     | 1624.3                               |
|  | <b>SURFACE AREA ROOF (sf)</b>  | BUILT UP ROOFING (B.U.R.)                     | 1705.5                               |
|  | <b>TOTAL SURFACE AREA (W+R)</b>  |   | 3329.8                               |
|  | <b>SURFACE TO VOLUME RATIO</b>   |   | 41%                                  |
|  | <b>INTERIOR MASS WALL</b>  | 1 1/2" ADOBE WALL<br>2 SIDES x 235.3 SF       | 18.6 B.T.<br>470.4 sf                |
|  | <b>INSULATION</b>  | <b>ROOF R VALUE</b>                           | NEW B.U.R. ABOVE ORIGINAL EARTH ROOF |
| <b>INSULATION</b>                        | <b>WALL R VALUE</b>  | 22" ADOBE W/ PLASTER                          | 0.81                                 |
|  | <b>PERIMETER SLAB INSULATION</b>   | CONC. SLAB                                    | NO                                   |
| <b>FENESTRATION</b>                      | <b>SOUTH WINDOW AREA (sf)</b>  | SHUTTERS                                      | 2.5                                  |
|  | <b>NORTH WINDOW AREA</b>   | SHUTTERS                                      | 2.8                                  |
|  | <b>EAST WINDOW AREA</b>  | SHUTTERS                                      | 41.5                                 |
|  | <b>WEST WINDOW AREA</b>  | SHUTTERS                                      | 41.5                                 |
|  | <b>TOTAL WINDOW AREA</b>   |   | 88.3                                 |
|  | <b>SOUTH WIN./ FLR. AREA RATIO</b>   |   | 3%                                   |
|  | <b>TOTAL WIN./FLR AREA RATIO</b>   |   | 13%                                  |
|  | <b>DOUBLE GLAZED LOW-E</b>   | SINGLE PANE                                   | NO                                   |
|  | <b>WINDOW MATERIAL</b>   | LIGHT CURTAINS INSIDE<br>CORALY BLUE SHUTTERS | WOOD                                 |
|  | <b>REFLECTIVITY</b>  | <b>ROOF REFLECTIVITY</b>                      | SILVER PAINTED B.U.R.                |
| <b>WALL REFLECTIVITY</b>                 |  | WHITE PLASTER                                 | 80%                                  |
| <b>GROUND REFLECTIVITY (april-sept.)</b> |  | SITE SURVEYED                                 | 0.4                                  |
| <b>GROUND REFLECTIVITY (oct.-march)</b>  |  | TYP. DESERT GROUND                            | 0.3                                  |
| <b>BLOWER DOOR</b>                       | <b>INFILTRATION (AIR CHANGES/ HR.)</b>   | 150 YR. OLD HOUSE                             | 2.5                                  |
| <b>CONDITIONING</b>                      | <b>NATURAL VENTILATION</b>   |   | YES                                  |
|  | <b>HEATING &amp; COOLING SYSTEM</b>  | PASSIVE                                       | NONE                                 |

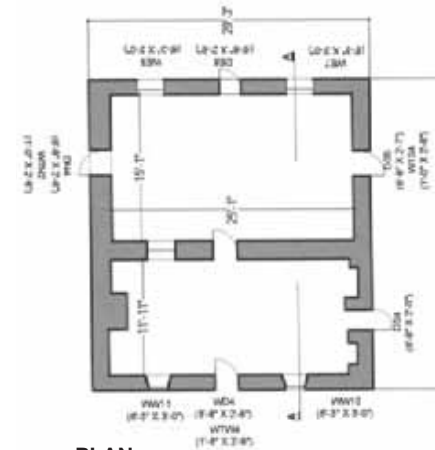

PLAN

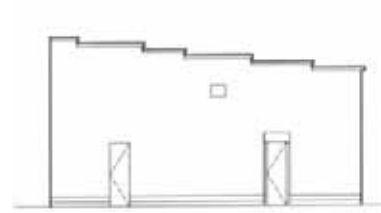
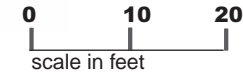

SOUTH ELEVATION



WEST ELEVATION

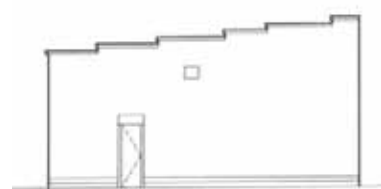

NORTH ELEVATION



EAST ELEVATION

# SUMMARY OF INPUT

|  |  |   |                                      |
|--|--|---|--------------------------------------|
| <b>CATEGORIES</b>                        | URBAN CASE #2 STEVENS HOUSE  |   |                                      |
|  |  |   |                                      |
| <b>SITE</b>                              | <b>DESCRIPTION</b>   |   | <b>BASE</b>                          |
|  | <b>OUTSIDE FILM COEFFICIENT</b>  | WINDSPEED 7.5 MPH                             | 4.0                                  |
|  | <b>WINDFACTOR</b>  | SEMI-ENCLOSED URBAN                           | 0.5                                  |
| <b>SIZE</b>                              | <b>FLOOR AREA (sf)</b>   |   | 1019.4                               |
|  | <b>VOLUME (cf)</b>   | AVERAGE 12' CEILING                           | 12232.8                              |
|  | <b>SURFACE AREA WALLS (sf)</b>   | 22" ADOBE                                     | 2364.5                               |
|  | <b>SURFACE AREA ROOF (sf)</b>  | BUILT UP ROOFING (B.U.R.)                     | 1070.0                               |
|  | <b>TOTAL SURFACE AREA (W+R)</b>  |   | 3434.5                               |
|  | <b>SURFACE TO VOLUME RATIO</b>   |   | 28.1%                                |
|  | <b>INTERIOR MASS WALL</b>  | 16" ADOBE WALL<br>2 SIDES x 850.0 SF          | 71.3 If<br>1710.0 m <sup>2</sup>     |
|  | <b>INSULATION</b>  | <b>ROOF R VALUE</b>                           | NEW B.U.R. ABOVE ORIGINAL EARTH ROOF |
|  | <b>WALL R VALUE</b>  | 22" ADOBE W/ PLASTER                          | 0.51                                 |
|  | <b>PERIMETER SLAB INSULATION</b>   | GONG. SLAB                                    | NO                                   |
| <b>FENESTRATION</b>                      | <b>SOUTH WINDOW AREA (sf)</b>  | SHUTTERS                                      | 0.0                                  |
|  | <b>NORTH WINDOW AREA</b>   | SHUTTERS                                      | 2.6                                  |
|  | <b>EAST WINDOW AREA</b>  | SHUTTERS                                      | 41.3                                 |
|  | <b>WEST WINDOW AREA</b>  | SHUTTERS                                      | 41.4                                 |
|  | <b>TOTAL WINDOW AREA</b>   |   | 86.3                                 |
|  | <b>SOUTH WIN./ FLR. AREA RATIO</b>   |   | 0%                                   |
|  | <b>TOTAL WIN./FLR AREA RATIO</b>   |   | 8.3%                                 |
|  | <b>DOUBLE GLAZED LOW-E</b>   | SINGLE PANE                                   | NO                                   |
|  | <b>WINDOW MATERIAL</b>   | LIGHT CURTAINS INSIDE<br>COBALT BLUE SHUTTERS | WOOD                                 |
|  | <b>REFLECTIVITY</b>  | <b>ROOF REFLECTIVITY</b>                      | SILVER PAINTED B.U.R.                |
| <b>WALL REFLECTIVITY</b>                 |  | WHITE PLASTER                                 | 80%                                  |
| <b>GROUND REFLECTIVITY (april-sept.)</b> |  | SITE SURVEYED                                 | 0.4                                  |
| <b>GROUND REFLECTIVITY (oct.-march)</b>  |  | TYP. DESERT GROUND                            | 0.3                                  |
| <b>BLOWER DOOR</b>                       | <b>INFILTRATION (AIR CHANGES/ HR.)</b>   | 150 YR. OLD HOUSE                             | 2.5                                  |
| <b>CONDITIONING</b>                      | <b>NATURAL VENTILATION</b>   |   | YES                                  |
|  | <b>HEATING &amp; COOLING SYSTEM</b>  | PASSIVE                                       | NONE                                 |

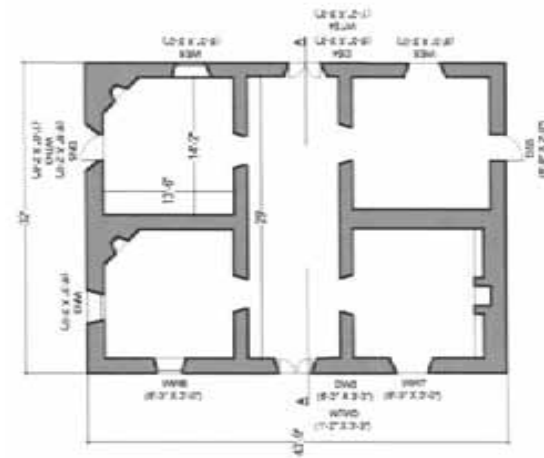

PLAN

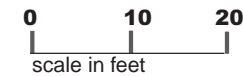

SOUTH ELEVATION

WEST ELEVATION

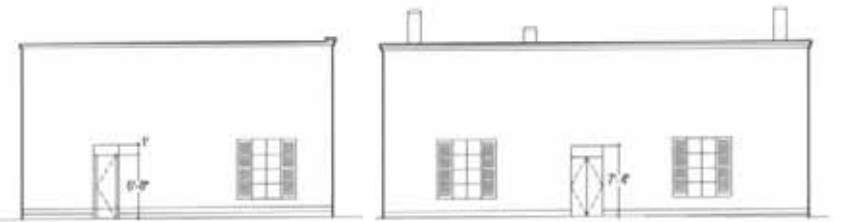

NORTH ELEVATION

EAST ELEVATION



**URBAN ADOBE: DUFFIELD HOUSE NATURAL VENTILATION**  
 DUFFIELD BY: NEUMANN CALPAS3 V3.12 License: PC0201  
 TUCSON, AZ Weather: TUCSON.AZ (Tucson AZ ETMY)  
 M O N T H L Y H O U S E E N E R G Y B A L A N C E (kBtu; + into house)

| MON | GAINS & LOSSES |       |         |        |        |      | TRANSFERS |        |      |      |
|-----|----------------|-------|---------|--------|--------|------|-----------|--------|------|------|
|     | COND           | SHCND | INFIL   | SLR    | INT    | STRG | RB+SS     | VENT   | COOL | HEAT |
| JAN | -3093.4        |       | -2.592  | 1288.8 | 2116.1 | -303 |           | 0      | 0    | 0    |
| FEB | -3769.1        |       | -2.955  | 1564.9 | 1911.3 | 289  |           | 0      | 0    | 0    |
| MAR | -2066.2        |       | -2.357  | 918.47 | 2116.1 | -943 | -4.056    | 0      | 0    | 0    |
| APR | -704.52        |       | -1.633  | 917.54 | 2047.8 | -664 | -1588.7   | 0      | 0    | 0    |
| MAY | 1165.1         |       | -0.496  | 434.30 | 2116.1 | -460 | -3245.7   | 0      | 0    | 0    |
| JUN | 1554.5         |       | -0.312  | 405.04 | 2047.8 | -978 | -3010.2   | 0      | 0    | 0    |
| JUL | 337.59         |       | -0.574  | 335.78 | 2116.1 | 743  | -3549.3   | 0      | 0    | 0    |
| AUG | 955.53         |       | -0.435  | 325.01 | 2116.1 | -535 | -2847.5   | 0      | 0    | 0    |
| SEP | 129.57         |       | -0.579  | 536.01 | 2047.8 | 760  | -3487.5   | 0      | 0    | 0    |
| OCT | -1012.9        |       | -1.275  | 601.47 | 2116.1 | 484  | -2195.5   | 0      | 0    | 0    |
| NOV | -4619.2        |       | -3.168  | 1359.3 | 2047.8 | 1440 | -245.00   | 0      | 0    | 0    |
| DEC | -4289.8        |       | -3.051  | 1194.7 | 2116.1 | 962  |           | 0      | 0    | 0    |
| TOT | -15413         |       | -19.428 | 9881.3 | 24915  | 794  |           | -20174 | 0    | 0    |

M O N T H L Y C O N D I T I O N S (Units as shown)

| MON | TEMPERATURES (F) |     |     |     | WTHR (F; Btu/sf) |     |     |     | PEAKS (kBtuh) |      |         |         |         |         |
|-----|------------------|-----|-----|-----|------------------|-----|-----|-----|---------------|------|---------|---------|---------|---------|
|     | THL              | THH | THM | TSL | TSH              | TSM | DBL | DBH | DBM           | SGL  | HSCL/DY | HSHT/DY | SSCL/DY | SSHT/DY |
| JAN | 59               | 63  | 61  |     |                  |     | 41  | 63  | 51            | 1087 | 0       | 0       |         |         |
| FEB | 61               | 67  | 64  |     |                  |     | 38  | 66  | 52            | 1427 | 0       | 0       |         |         |
| MAR | 66               | 71  | 68  |     |                  |     | 45  | 74  | 60            | 1873 | 0       | 0       |         |         |
| APR | 70               | 76  | 73  |     |                  |     | 51  | 81  | 67            | 2389 | 0       | 0       |         |         |
| MAY | 71               | 79  | 76  |     |                  |     | 56  | 88  | 74            | 2692 | 0       | 0       |         |         |
| JUN | 81               | 89  | 86  |     |                  |     | 70  | 97  | 85            | 2720 | 0       | 0       |         |         |
| JUL | 84               | 91  | 88  |     |                  |     | 75  | 97  | 85            | 2309 | 0       | 0       |         |         |
| AUG | 82               | 88  | 86  |     |                  |     | 74  | 95  | 84            | 2185 | 0       | 0       |         |         |
| SEP | 78               | 85  | 82  |     |                  |     | 70  | 90  | 80            | 1963 | 0       | 0       |         |         |
| OCT | 72               | 77  | 75  |     |                  |     | 58  | 83  | 70            | 1634 | 0       | 0       |         |         |
| NOV | 68               | 72  | 70  |     |                  |     | 47  | 70  | 58            | 1207 | 0       | 0       |         |         |
| DEC | 61               | 65  | 63  |     |                  |     | 41  | 65  | 52            | 1014 | 0       | 0       |         |         |
| TOT | 71               | 77  | 74  |     |                  |     | 56  | 81  | 68            | 1877 | 0       | 0       |         |         |

Note: CALPAS3 is the property of and is licensed by Berkeley Solar Group, 3140 Martin Luther King Jr. Way, Berkeley, CA 94703 (415 843-7600). Correct application and operation of CALPAS3 is the responsibility of the user. Actual building performance may deviate from CALPAS3 predictions due to differences between actual and assumed weather, construction, or occupancy. CALPAS3 is certified for California energy code compliance when used in accordance with the BSG publication "Using CALPAS3 with the California Residential Building Standards."



**URBAN ADOBE: STEVENS HOUSE NATURAL VENTILATION**  
 STEVENS BY: NEUMANN CALPAS3 V3.12 License: PC0201  
 TUCSON, AZ Weather: TUCSON.AZ (Tucson AZ ETMY)  
 M O N T H L Y H O U S E E N E R G Y B A L A N C E (kBtu; + into house)

| MON | GAINS & LOSSES |       |         |        |        |       | TRANSFERS |      |      |      |
|-----|----------------|-------|---------|--------|--------|-------|-----------|------|------|------|
|     | COND           | SHCND | INFIL   | SLR    | INT    | STRG  | RB+SS     | VENT | COOL | HEAT |
| JAN | -1079.5        |       | -1556.2 | 1060.9 | 2116.1 | -529  |           |      | 0    | 0    |
| FEB | -1829.6        |       | -1943.7 | 1310.1 | 1911.3 | 539   |           |      | 0    | 0    |
| MAR | 66.394         |       | -1318.3 | 799.84 | 2116.1 | -1628 |           |      | 0    | 0    |
| APR | 215.17         |       | -1450.0 | 844.45 | 2047.8 | -1622 |           |      | 0    | 0    |
| MAY | 113.83         |       | -1552.6 | 396.28 | 2116.1 | -1051 |           |      | 0    | 0    |
| JUN | 604.62         |       | -1274.5 | 378.67 | 2047.8 | -1718 |           |      | 0    | 0    |
| JUL | -1582.3        |       | -2055.3 | 316.32 | 2116.1 | 1179  |           |      | 0    | 0    |
| AUG | -220.88        |       | -1482.8 | 297.16 | 2116.1 | -694  |           |      | 0    | 0    |
| SEP | -1715.6        |       | -2007.5 | 480.55 | 2047.8 | 1169  |           |      | 0    | 0    |
| OCT | -1906.5        |       | -2013.8 | 506.60 | 2116.1 | 1269  |           |      | 0    | 0    |
| NOV | -3544.9        |       | -2602.3 | 1112.9 | 2047.8 | 2923  |           |      | 0    | 0    |
| DEC | -2556.3        |       | -2138.0 | 972.13 | 2116.1 | 1571  |           |      | 0    | 0    |
| TOT | -13436         |       | -21395  | 8475.9 | 24915  | 1408  |           |      | 0    | 0    |

M O N T H L Y C O N D I T I O N S (Units as shown)

| MON | TEMPERATURES (F) |     |     |     | WTHR (F; Btu/sf) |     |     |     | PEAKS (kBtuh) |      |         |         |         |         |
|-----|------------------|-----|-----|-----|------------------|-----|-----|-----|---------------|------|---------|---------|---------|---------|
|     | THL              | THH | THM | TSL | TSH              | TSM | DBL | DBH | DBM           | SGL  | HSCL/DY | HSHT/DY | SSCL/DY | SSHT/DY |
| JAN | 53               | 57  | 55  |     |                  |     | 41  | 63  | 51            | 1087 | 0       | 0       |         |         |
| FEB | 54               | 60  | 57  |     |                  |     | 38  | 66  | 52            | 1427 | 0       | 0       |         |         |
| MAR | 60               | 65  | 63  |     |                  |     | 45  | 74  | 60            | 1873 | 0       | 0       |         |         |
| APR | 68               | 73  | 71  |     |                  |     | 51  | 81  | 67            | 2389 | 0       | 0       |         |         |
| MAY | 75               | 80  | 78  |     |                  |     | 56  | 88  | 74            | 2692 | 0       | 0       |         |         |
| JUN | 85               | 90  | 88  |     |                  |     | 70  | 97  | 85            | 2720 | 0       | 0       |         |         |
| JUL | 89               | 92  | 90  |     |                  |     | 75  | 97  | 85            | 2309 | 0       | 0       |         |         |
| AUG | 86               | 89  | 87  |     |                  |     | 74  | 95  | 84            | 2185 | 0       | 0       |         |         |
| SEP | 83               | 86  | 85  |     |                  |     | 70  | 90  | 80            | 1963 | 0       | 0       |         |         |
| OCT | 73               | 77  | 75  |     |                  |     | 58  | 83  | 70            | 1634 | 0       | 0       |         |         |
| NOV | 62               | 66  | 64  |     |                  |     | 47  | 70  | 58            | 1207 | 0       | 0       |         |         |
| DEC | 55               | 59  | 57  |     |                  |     | 41  | 65  | 52            | 1014 | 0       | 0       |         |         |
| TOT | 70               | 75  | 73  |     |                  |     | 56  | 81  | 68            | 1877 | 0       | 0       |         |         |

# SUMMARY OF INPUT

|                                    |  |   |                       |                     |
|------------------------------------|--|---|-----------------------|---------------------|
| <b>CATEGORIES</b>                  | URBAN CASE #3 FISH HOUSE   |   |                       |                     |
|                                    |   |   |                       |                     |
|                                    | LAT=32 LONG=110<br>14d E OF 5  |   |                       |                     |
| <b>SITE</b>                        | DESCRIPTION  |   | BASE                  |                     |
|                                    | OUTSIDE FILM COEFFICIENT   | WINDSPEED 7.5 MPH                             | 4.0                   |                     |
|                                    | WINDFACTOR   | SEMI-ENCLOSED URBAN                           | 0.5                   |                     |
| <b>SIZE</b>                        | FLOOR AREA (sf)  |   | 2135.0                |                     |
|                                    | VOLUME (cf)  | AVERAGE 12' CEILING                           | 25600.8               |                     |
|                                    | SURFACE AREA WALLS (sf)  | 22" ADOBE                                     | 5337.1                |                     |
|                                    | SURFACE AREA ROOF (sf)   | BUILT UP ROOFING (B.U.R.)                     | 2242.7                |                     |
|                                    | TOTAL SURFACE AREA (W+R)   |   | 7579.8                |                     |
|                                    | SURFACE TO VOLUME RATIO  |   | 29.8%                 |                     |
|                                    | INTERIOR MASS WALL   | 14" ADOBE WALL<br>2 SIDES x 927.8 SF          |                       | 77.3 F<br>1855.2 sf |
| <b>INSULATION</b>                  | ROOF R VALUE   | NEW 8.11" ADOBE<br>ORIGINAL EARTH ROOF        | 0.2                   |                     |
|                                    | WALL R VALUE   | 22" ADOBE W/ PLASTER                          | 0.51                  |                     |
|                                    | PERIMETER SLAB INSULATION  | CONC. SLAB                                    | NO                    |                     |
| <b>FENESTRATION</b>                | SOUTH WINDOW AREA (sf)   | SHUTTERS                                      | 94.3                  |                     |
|                                    | NORTH WINDOW AREA  | SHUTTERS                                      | 21.0                  |                     |
|                                    | EAST WINDOW AREA   | SHUTTERS                                      | 48.6                  |                     |
|                                    | WEST WINDOW AREA   | SHUTTERS                                      | 92.5                  |                     |
|                                    | TOTAL WINDOW AREA  |   | 256.4                 |                     |
|                                    | SOUTH WIN./ FLR. AREA RATIO  |   | 4.0%                  |                     |
|                                    | TOTAL WIN./FLR AREA RATIO  |   | 12%                   |                     |
|                                    | DOUBLE GLAZED LOW-E  | SINGLE PANE                                   | NO                    |                     |
|                                    | WINDOW MATERIAL  | LIGHT CURTAINS INSIDE<br>COBALT BLUE SHUTTERS | WOOD                  |                     |
|                                    | <b>REFLECTIVITY</b>  | ROOF REFLECTIVITY                             | SILVER PAINTED B.U.R. | 81%                 |
|                                    |  | WALL REFLECTIVITY                             | WHITE PLASTER         | 80%                 |
| GROUND REFLECTIVITY (april-augpt.) |  | SITE SURVEYED                                 | 0.4                   |                     |
| GROUND REFLECTIVITY (oct.-march)   |  | TYP. DESERT GROUND                            | 0.3                   |                     |
| <b>BLOWER DOOR</b>                 | INFILTRATION (AIR CHANGES/ HR.)  | 150 YR. OLD HOUSE                             | 2.5                   |                     |
| <b>CONDITIONING</b>                | NATURAL VENTILATION  |   | YES                   |                     |
|                                    | HEATING & COOLING SYSTEM   | PASSIVE                                       | NONE                  |                     |

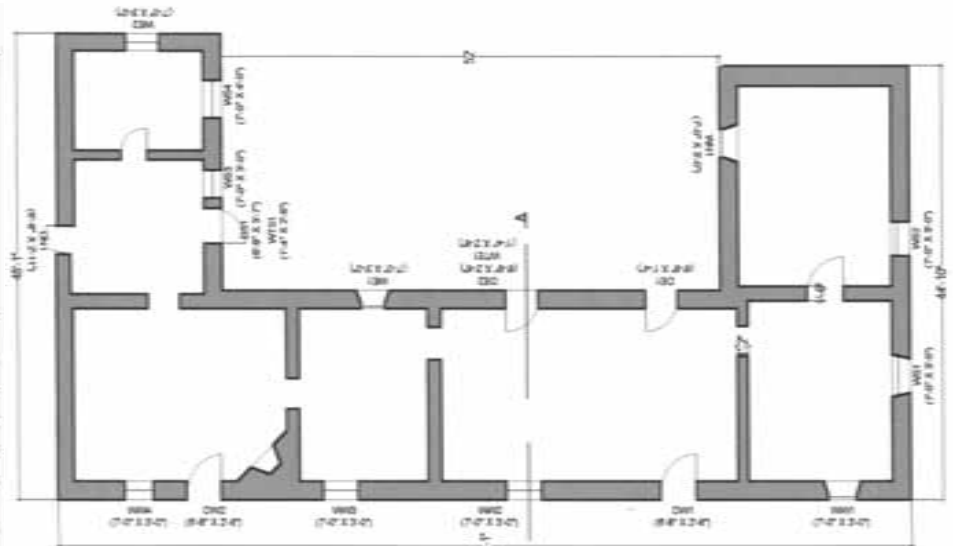

PLAN

0 10 20  
scale in feet

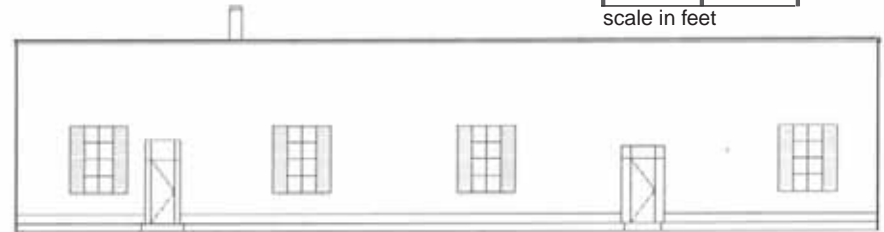

WEST ELEVATION



EAST ELEVATION



SOUTH ELEVATION

NORTH ELEVATION

**URBAN ADOBE: FISH HOUSE NO VENTILATION**

FISH NO VENT BY: NEUMANN CALPAS3 V3.12 License: PC0201  
 TUCSON, AZ Weather: TUCSON.AZ (Tucson AZ ETMY)  
 M O N T H L Y H O U S E E N E R G Y B A L A N C E (kBtu; + into house)

| MON | GAINS & LOSSES |       |         |        |        |       | TRANSFERS |      |      |      |
|-----|----------------|-------|---------|--------|--------|-------|-----------|------|------|------|
|     | COND           | SHCND | INFIL   | SLR    | INT    | STRG  | RB+SS     | VENT | COOL | HEAT |
| JAN | -1953.7        |       | -3310.4 | 4349.9 | 2116.1 | -1178 |           |      | 0    | 0    |
| FEB | -3453.9        |       | -4065.1 | 4500.5 | 1911.3 | 1084  |           |      | 0    | 0    |
| MAR | 1443.6         |       | -2448.9 | 2244.7 | 2116.1 | -3292 |           |      | 0    | 0    |
| APR | 1813.6         |       | -2740.9 | 2230.3 | 2047.8 | -3287 |           |      | 0    | 0    |
| MAY | 1817.3         |       | -2894.2 | 1074.3 | 2116.1 | -2075 |           |      | 0    | 0    |
| JUN | 2797.9         |       | -2373.8 | 983.41 | 2047.8 | -3390 |           |      | 0    | 0    |
| JUL | -1765.6        |       | -3724.1 | 865.58 | 2116.1 | 2459  |           |      | 0    | 0    |
| AUG | 1140.2         |       | -2581.3 | 882.07 | 2116.1 | -1525 |           |      | 0    | 0    |
| SEP | -2423.7        |       | -3760.8 | 1693.8 | 2047.8 | 2397  |           |      | 0    | 0    |
| OCT | -2796.0        |       | -3747.3 | 1906.6 | 2116.1 | 2474  |           |      | 0    | 0    |
| NOV | -7175.5        |       | -5342.3 | 4460.3 | 2047.8 | 5898  |           |      | 0    | 0    |
| DEC | -5221.5        |       | -4462.1 | 4248.3 | 2116.1 | 3255  |           |      | 0    | 0    |
| TOT | -15777         |       | -41451  | 29440  | 24915  | 2819  |           |      | 0    | 0    |

M O N T H L Y C O N D I T I O N S (Units as shown)

| MON | TEMPERATURES (F) |     |     |     | WTHR (F; Btu/sf) |     |     |     | PEAKS (kBtuh) |      |         |         |         |         |
|-----|------------------|-----|-----|-----|------------------|-----|-----|-----|---------------|------|---------|---------|---------|---------|
|     | THL              | THH | THM | TSL | TSH              | TSM | DBL | DBH | DBM           | SGL  | HSCL/DY | HSHT/DY | SSCL/DY | SSHT/DY |
| JAN | 53               | 58  | 55  |     |                  |     | 41  | 63  | 51            | 1087 | 0       | 0       |         |         |
| FEB | 54               | 60  | 57  |     |                  |     | 38  | 66  | 52            | 1427 | 0       | 0       |         |         |
| MAR | 59               | 65  | 62  |     |                  |     | 45  | 74  | 60            | 1873 | 0       | 0       |         |         |
| APR | 67               | 73  | 70  |     |                  |     | 51  | 81  | 67            | 2389 | 0       | 0       |         |         |
| MAY | 74               | 80  | 77  |     |                  |     | 56  | 88  | 74            | 2692 | 0       | 0       |         |         |
| JUN | 84               | 90  | 87  |     |                  |     | 70  | 97  | 85            | 2720 | 0       | 0       |         |         |
| JUL | 88               | 92  | 90  |     |                  |     | 75  | 97  | 85            | 2309 | 0       | 0       |         |         |
| AUG | 85               | 89  | 87  |     |                  |     | 74  | 95  | 84            | 2185 | 0       | 0       |         |         |
| SEP | 82               | 86  | 84  |     |                  |     | 70  | 90  | 80            | 1963 | 0       | 0       |         |         |
| OCT | 72               | 77  | 74  |     |                  |     | 58  | 83  | 70            | 1634 | 0       | 0       |         |         |
| NOV | 62               | 67  | 64  |     |                  |     | 47  | 70  | 58            | 1207 | 0       | 0       |         |         |
| DEC | 54               | 59  | 57  |     |                  |     | 41  | 65  | 52            | 1014 | 0       | 0       |         |         |
| TOT | 69               | 75  | 72  |     |                  |     | 56  | 81  | 68            | 1877 | 0       | 0       |         |         |

**URBAN ADOBE: FISH HOUSE NATURAL VENTILATION**

FISH NAT VENT BY: NEUMANN CALPAS3 V3.12 License: PC0201  
 TUCSON, AZ Weather: TUCSON.AZ (Tucson AZ ETMY)  
 M O N T H L Y H O U S E E N E R G Y B A L A N C E (kBtu; + into house)

| MON | GAINS & LOSSES |       |         |        |        |       | TRANSFERS |         |      |      |
|-----|----------------|-------|---------|--------|--------|-------|-----------|---------|------|------|
|     | COND           | SHCND | INFIL   | SLR    | INT    | STRG  | RB+SS     | VENT    | COOL | HEAT |
| JAN | -1982.8        |       | -3284.0 | 4349.9 | 2116.1 | -1176 |           | 0       | 0    | 0    |
| FEB | -3488.0        |       | -4033.9 | 4500.5 | 1911.3 | 1087  |           | 0       | 0    | 0    |
| MAR | 1384.5         |       | -2405.6 | 2244.7 | 2116.1 | -3276 |           | 0       | 0    | 0    |
| APR | 2450.0         |       | -2279.4 | 2236.0 | 2047.8 | -3142 |           | -1256.7 | 0    | 0    |
| MAY | 4774.0         |       | -734.64 | 1076.8 | 2116.1 | -1678 |           | -5524.6 | 0    | 0    |
| JUN | 6174.5         |       | 32.846  | 983.41 | 2047.8 | -3212 |           | -5967.5 | 0    | 0    |
| JUL | 2422.9         |       | -783.64 | 865.58 | 2116.1 | 2490  |           | -7166.9 | 0    | 0    |
| AUG | 4482.3         |       | -258.91 | 882.07 | 2116.1 | -1804 |           | -5371.8 | 0    | 0    |
| SEP | 1592.2         |       | -896.95 | 1693.8 | 2047.8 | 2561  |           | -7048.5 | 0    | 0    |
| OCT | -582.67        |       | -2234.9 | 1908.9 | 2116.1 | 1854  |           | -3090.4 | 0    | 0    |
| NOV | -7172.8        |       | -5296.2 | 4460.5 | 2047.8 | 5865  |           | -14.840 | 0    | 0    |
| DEC | -5242.7        |       | -4435.4 | 4248.3 | 2116.1 | 3250  |           | 0       | 0    | 0    |
| TOT | 4811.2         |       | -26611  | 29451  | 24915  | 2821  |           | -35441  | 0    | 0    |

M O N T H L Y C O N D I T I O N S (Units as shown)

| MON | TEMPERATURES (F) |     |     |     | WTHR (F; Btu/sf) |     |     |     | PEAKS (kBtuh) |      |         |         |         |         |
|-----|------------------|-----|-----|-----|------------------|-----|-----|-----|---------------|------|---------|---------|---------|---------|
|     | THL              | THH | THM | TSL | TSH              | TSM | DBL | DBH | DBM           | SGL  | HSCL/DY | HSHT/DY | SSCL/DY | SSHT/DY |
| JAN | 53               | 58  | 55  |     |                  |     | 41  | 63  | 51            | 1087 | 0       | 0       |         |         |
| FEB | 54               | 60  | 57  |     |                  |     | 38  | 66  | 52            | 1427 | 0       | 0       |         |         |
| MAR | 59               | 65  | 62  |     |                  |     | 45  | 74  | 60            | 1873 | 0       | 0       |         |         |
| APR | 66               | 73  | 70  |     |                  |     | 51  | 81  | 67            | 2389 | 0       | 0       |         |         |
| MAY | 70               | 78  | 75  |     |                  |     | 56  | 88  | 74            | 2692 | 0       | 0       |         |         |
| JUN | 80               | 88  | 84  |     |                  |     | 70  | 97  | 85            | 2720 | 0       | 0       |         |         |
| JUL | 83               | 89  | 86  |     |                  |     | 75  | 97  | 85            | 2309 | 0       | 0       |         |         |
| AUG | 81               | 87  | 84  |     |                  |     | 74  | 95  | 84            | 2185 | 0       | 0       |         |         |
| SEP | 77               | 84  | 81  |     |                  |     | 70  | 90  | 80            | 1963 | 0       | 0       |         |         |
| OCT | 70               | 75  | 73  |     |                  |     | 58  | 83  | 70            | 1634 | 0       | 0       |         |         |
| NOV | 62               | 67  | 64  |     |                  |     | 47  | 70  | 58            | 1207 | 0       | 0       |         |         |
| DEC | 54               | 59  | 57  |     |                  |     | 41  | 65  | 52            | 1014 | 0       | 0       |         |         |
| TOT | 67               | 74  | 71  |     |                  |     | 56  | 81  | 68            | 1877 | 0       | 0       |         |         |

Note: CALPAS3 is the property of and is licensed by Berkeley Solar Group, 3140 Martin Luther King Jr. Way, Berkeley, CA 94703 (415 843-7600). Correct application and operation of CALPAS3 is the responsibility of the user. Actual building performance may deviate from CALPAS3 predictions due to differences between actual and assumed weather, construction, or occupancy. CALPAS3 is certified for California energy code compliance when used in accordance with the BSG publication "Using CALPAS3 with the California Residential Building Standards."

# SUMMARY OF INPUT

|                     |  |                                      |                    |
|---------------------|--|--------------------------------------|--------------------|
| <b>CATEGORIES</b>   | <b>RURAL CASE #1 UPSHAW PHASE 1: SQUARE ADOBE PLAN</b>                             |                                      |                    |
|                     |  |                                      |                    |
| <b>SITE</b>         | LAT=31 LONG=108<br>7d E OF 6   |                                      |                    |
| <b>SIZE</b>         | <b>DESCRIPTION</b>   |                                      | <b>BASE</b>        |
|                     | <b>OUTSIDE FILM COEFFICIENT</b>  | AVE. WINDSPEED 15.0 MPH              | 6.0                |
| <b>INSULATION</b>   | <b>WINDFACTOR</b>  | OPEN SITE<br>A FEW LARGE TREES       | 0.75               |
|                     | <b>FLOOR AREA (sf)</b>   |                                      | 629.7              |
|                     | <b>VOLUME (cf)</b>   | AVERAGE 7.75' CEILING                | 4827.8             |
|                     | <b>SURFACE AREA WALLS (sf)</b>   | 12" ADOBE                            | 893.7              |
|                     | <b>SURFACE AREA ROOF (sf)</b>  | SILVER GALV. MTL. ROOF               | 1122.0             |
|                     | <b>TOTAL SURFACE AREA (W+R)</b>  |                                      | 1815.7             |
|                     | <b>SURFACE TO VOLUME RATIO</b>   |                                      | 37.6%              |
|                     | <b>INTERIOR MASS WALL</b>  | 12" ADOBE WALL<br>2 SIDES x 252.8 SF | 31.8 B<br>505.6 SF |
| <b>FENESTRATION</b> | <b>ROOF R VALUE</b>  | GALV. METAL W/<br>ROCK WOOL INSUL.   | 0.1                |
|                     | <b>WALL R VALUE</b>  | 12" ADOBE W/ PLASTER                 | 0.83               |
| <b>REFLECTIVITY</b> | <b>PERIMETER SLAB INSULATION</b>   | CONC. SLAB                           | NO                 |
|                     | <b>SOUTH WINDOW AREA (sf)</b>  |                                      | 27.5               |
|                     | <b>NORTH WINDOW AREA</b>   |                                      | 23.0               |
|                     | <b>EAST WINDOW AREA</b>  |                                      | 11.5               |
|                     | <b>WEST WINDOW AREA</b>  |                                      | 23.8               |
|                     | <b>TOTAL WINDOW AREA</b>   |                                      | 102.3              |
|                     | <b>SOUTH WIN./ FLR. AREA RATIO</b>   |                                      | 4.4%               |
|                     | <b>TOTAL WIN./FLR AREA RATIO</b>   |                                      | 13.8%              |
|                     | <b>DOUBLE GLAZED LOW-E</b>   | SINGLE PANE                          | NO                 |
|                     | <b>WINDOW MATERIAL</b>   | NO LIGHT CURTAINS<br>NO SHUTTERS     | WOOD               |
| <b>BLOWER DOOR</b>  | <b>ROOF REFLECTIVITY</b>   | SILVER GALV. MTL. ROOF               | 81%                |
|                     | <b>WALL REFLECTIVITY</b>   | WHITE PLASTER                        | 80%                |
|                     | <b>GROUND REFLECTIVITY (april-sept.)</b>   | GRASSLAND -DRY                       | 0.32               |
|                     | <b>GROUND REFLECTIVITY (oct.-march)</b>  | GRASSLAND -DRY                       | 0.32               |
| <b>CONDITIONING</b> | <b>INFILTRATION (AIR CHANGES/ HR.)</b>   | 75 YR. OLD HOUSE                     | 2.5                |
| <b>BLOWER DOOR</b>  | <b>NATURAL VENTILATION</b>   |                                      | YES                |
|                     | <b>HEATING &amp; COOLING SYSTEM</b>  | PASSIVE                              | NONE               |

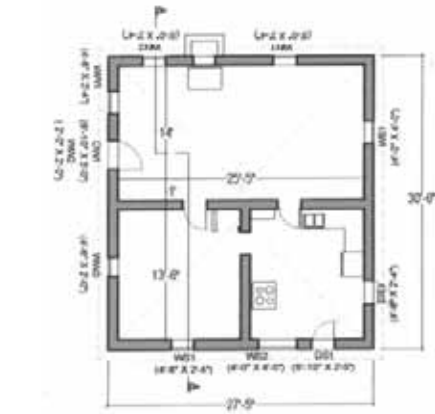

PLAN

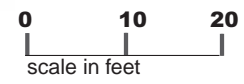

SOUTH ELEVATION



WEST ELEVATION



NORTH ELEVATION



EAST ELEVATION

# SUMMARY OF INPUT

|                     |  |                                    |                     |
|---------------------|--|------------------------------------|---------------------|
| <b>CATEGORIES</b>   | RURAL CASE #2 UPSHAW PHASE 2: PORCH ADDITION                                       |                                    |                     |
|                     |  |                                    |                     |
| <b>SITE</b>         | LAT=31 LONG=108<br>7d E OF S   |                                    |                     |
| <b>SIZE</b>         | <b>FLOOR AREA (sf)</b>   |                                    | 629.7               |
|                     | <b>VOLUME (cf)</b>   | AVERAGE 7.75' CEILING              | 4827.9              |
| <b>INSULATION</b>   | <b>OUTSIDE FILM COEFFICIENT</b>  | AVE. WINDSPEED 15.0 MPH            | 6.0                 |
|                     | <b>WINDFACTOR</b>  | OPEN SITE<br>A FEW LARGE TREES     | 0.75                |
|                     | <b>SURFACE AREA WALLS (sf)</b>   | 12" ADOBE                          | 693.7               |
|                     | <b>SURFACE AREA ROOF (sf)</b>  | SILVER GALV. MTL. ROOF             | 1122.0              |
|                     | <b>TOTAL SURFACE AREA (W+R)</b>  |                                    | 1815.7              |
|                     | <b>SURFACE TO VOLUME RATIO</b>   |                                    | 37.6%               |
|                     | <b>INTERIOR MASS WALL</b>  | 12" ADOBE WALL<br>2 SIDES x XXX SF | 51.8 SF<br>806.6 sf |
|                     | <b>PERIMETER SLAB INSULATION</b>   | CONC. SLAB                         | NO                  |
| <b>FENESTRATION</b> | <b>ROOF R VALUE</b>  | GALV. METAL W/<br>ROCK WOOL INSUL. | 0.1                 |
|                     | <b>WALL R VALUE</b>  | 12" ADOBE W/ PLASTER               | 0.03                |
|                     | <b>SOUTH WINDOW AREA (sf)</b>  | 7.5' DEEP PORCH                    | 27.5                |
|                     | <b>NORTH WINDOW AREA</b>   |                                    | 23.0                |
|                     | <b>EAST WINDOW AREA</b>  |                                    | 11.5                |
|                     | <b>WEST WINDOW AREA</b>  | 8' DEEP PORCH                      | 23.8                |
|                     | <b>TOTAL WINDOW AREA</b>   |                                    | 85.8                |
|                     | <b>SOUTH WIN./ FLR. AREA RATIO</b>   |                                    | 4.4%                |
|                     | <b>TOTAL WIN./FLR. AREA RATIO</b>  |                                    | 13.6%               |
|                     | <b>DOUBLE GLAZED LOW-E</b>   | SINGLE PANE                        | NO                  |
| <b>REFLECTIVITY</b> | <b>WINDOW MATERIAL</b>   | NO LIGHT CURTAINS<br>NO SHUTTERS   | WOOD                |
|                     | <b>ROOF REFLECTIVITY</b>   | SILVER GALV. MTL. ROOF             | 61%                 |
|                     | <b>WALL REFLECTIVITY</b>   | WHITE PLASTER                      | 80%                 |
|                     | <b>GROUND REFLECTIVITY (april-sept.)</b>   | GRASSLAND -DRY                     | 0.32                |
| <b>BLOWER DOOR</b>  | <b>GROUND REFLECTIVITY (oct.-march)</b>  | GRASSLAND -DRY                     | 0.32                |
|                     | <b>INFILTRATION (AIR CHANGES/ HR.)</b>   | 75 YR. OLD HOUSE                   | 2.5                 |
| <b>CONDITIONING</b> | <b>NATURAL VENTILATION</b>   |                                    | YES                 |
|                     | <b>HEATING &amp; COOLING SYSTEM</b>  | PASSIVE                            | NONE                |

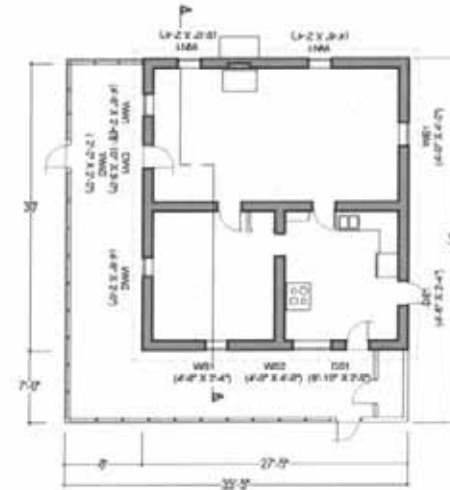

PLAN

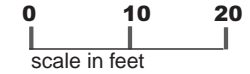

SOUTH ELEVATION



WEST ELEVATION





NORTH ELEVATION



EAST ELEVATION

# SUMMARY OF INPUT

|  |   |   |                        |
|--|---|---|------------------------|
| <b>CATEGORIES</b>                        | <b>RURAL CASE #X UPSHAW PHASE</b>   |   |                        |
|  |  |  |                        |
|  | LAT=31 LONG=108<br>7d E OF 8  |   |                        |
| <b>SITE</b>                              | <b>DESCRIPTION</b>  |   | <b>BASE</b>            |
|  | <b>OUTSIDE FILM COEFFICIENT</b>   | AVE. WINDSPEED 15.0 MPH   | 8.0                    |
| <b>SIZE</b>                              | <b>WINDFACTOR</b>   | OPEN SITE<br>A FEW LARGE TREES  | 0.75                   |
|  | <b>FLOOR AREA (sf)</b>  |   | 1169.5                 |
|  | <b>VOLUME (cf)</b>  | AVERAGE 7.75' CEILING   | 15305.9                |
|  | <b>SURFACE AREA WALLS (sf)</b>  | 12" ADOBE   | 1186.1                 |
|  | <b>SURFACE AREA ROOF (sf)</b>   | SILVER GALV. MTL. ROOF  | 1731.8                 |
|  | <b>TOTAL SURFACE AREA (W+R)</b>   |   | 2918.9                 |
|  | <b>SURFACE TO VOLUME RATIO</b>  |   | 19%                    |
| <b>INSULATION</b>                        | <b>INTERIOR MASS WALL</b>   | 12" ADOBE WALL<br>2 SIDES x 367.6 SF  | 44.7 #<br>715.2 sf     |
|  | <b>ROOF R VALUE</b>   | GALV. METAL W/<br>ROCK WOOL INSUL.  | 0.1                    |
|  | <b>WALL R VALUE</b>   | 12" ADOBE W/ PLASTER  | 0.93                   |
| <b>FENESTRATION</b>                      | <b>PERIMETER SLAB INSULATION</b>  | CONC. SLAB  | NO                     |
|  | <b>SOUTH WINDOW AREA (sf)</b>   | DEEP PORCH<br>PARTIAL COVERAGE  | 39.3                   |
|  | <b>NORTH WINDOW AREA</b>  |   | 37.0                   |
|  | <b>EAST WINDOW AREA</b>   |   | 24.0                   |
|  | <b>WEST WINDOW AREA</b>   | DEEP PORCH<br>PARTIAL COVERAGE  | 23.8                   |
|  | <b>TOTAL WINDOW AREA</b>  |   | 124.1                  |
|  | <b>SOUTH WIN./ FLR. AREA RATIO</b>  |   | 3.3%                   |
|  | <b>TOTAL WIN./FLR AREA RATIO</b>  |   | 10.6%                  |
|  | <b>DOUBLE GLAZED LOW-E</b>  | SINGLE PANE   | NO                     |
|  | <b>WINDOW MATERIAL</b>  | NO LIGHT CURTAINS<br>NO SHUTTERS  | WOOD                   |
|  | <b>REFLECTIVITY</b>   | <b>ROOF REFLECTIVITY</b>  | SILVER GALV. MTL. ROOF |
| <b>WALL REFLECTIVITY</b>                 |   | WHITE PLASTER   | 80%                    |
| <b>GROUND REFLECTIVITY (april-sept.)</b> |   | GRASSLAND DRY   | 0.32                   |
| <b>GROUND REFLECTIVITY (oct.-march)</b>  |   | GRASSLAND DRY   | 0.32                   |
| <b>BLOWER DOOR</b>                       | <b>INFILTRATION (AIR CHANGES/ HR.)</b>  | 75 YR. OLD HOUSE  | 2.5                    |
| <b>CONDITIONING</b>                      | <b>NATURAL VENTILATION</b>  |   | YES                    |
|  | <b>HEATING &amp; COOLING SYSTEM</b>   | PASSIVE   | NONE                   |



PLAN

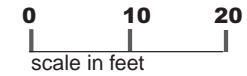

SOUTH ELEVATION



NORTH ELEVATION



WEST ELEVATION



EAST ELEVATION

**RURAL ADOBE: UPSHAW 1- NATURAL VENTILATION**

UPSHW 1 BY: NEUMANN CALPAS3 V3.12 License: PC0201  
 TUCSON, AZ Weather: TUCSON.AZ (Tucson AZ ETMY)

\* Note: Graphs reflect adjusted temperatures for cooler climate  
 Sierra Vista AZ (higher elev.) vs. Tucson AZ  
 Sierra Vista Ave. DBT Oct.-March (winter) - 9% < Tucson  
 Sierra Vista Ave. DBT April-September (summer) - 8% < Tucson

MONTHLY HOUSE ENERGY BALANCE (kBtu; + into house)

| MON | GAINS & LOSSES |        |         |        |        |      | TRANSFERS |      |      |      |
|-----|----------------|--------|---------|--------|--------|------|-----------|------|------|------|
|     | COND           | SHCOND | INFIL   | SLR    | INT    | STRG | RB+SS     | VENT | COOL | HEAT |
| JAN | -2146.9        |        | -1213.1 | 1482.4 | 2116.1 | -231 |           | 0    | 0    | 0    |
| FEB | -2205.8        |        | -1228.8 | 1444.5 | 1911.3 | 76.0 |           | 0    | 0    | 0    |
| MAR | -1985.5        |        | -1254.1 | 1623.7 | 2116.1 | -398 | -88.534   | 0    | 0    | 0    |
| APR | -1244.0        |        | -955.56 | 1578.7 | 2047.8 | -278 | -1143.6   | 0    | 0    | 0    |
| MAY | -419.22        |        | -593.14 | 1697.9 | 2116.1 | -154 | -2642.6   | 0    | 0    | 0    |
| JUN | -191.19        |        | -476.77 | 1601.2 | 2047.8 | -212 | -2762.2   | 0    | 0    | 0    |
| JUL | -445.10        |        | -486.91 | 1392.6 | 2116.1 | 334  | -2921.2   | 0    | 0    | 0    |
| AUG | -191.63        |        | -446.48 | 1369.8 | 2116.1 | -368 | -2467.4   | 0    | 0    | 0    |
| SEP | -502.53        |        | -483.66 | 1401.7 | 2047.8 | 313  | -2786.8   | 0    | 0    | 0    |
| OCT | -1283.7        |        | -844.01 | 1617.0 | 2116.1 | 138  | -1747.8   | 0    | 0    | 0    |
| NOV | -2759.6        |        | -1395.6 | 1505.1 | 2047.8 | 694  | -112.18   | 0    | 0    | 0    |
| DEC | -2588.3        |        | -1346.0 | 1461.5 | 2116.1 | 345  |           | 0    | 0    | 0    |
| TOT | -15963         |        | -10724  | 18176  | 24915  | 260  | -16672    | 0    | 0    | 0    |

MONTHLY CONDITIONS (Units as shown)

\* THM adjusted to right of THM w/ Tucson AZ Weather Files)

| MON | TEMPERATURES (F) |     |         |     | WTHR (F; Btu/sf) |     |     |     | PEAKS (kBtuh) |      |         |         |         |         |
|-----|------------------|-----|---------|-----|------------------|-----|-----|-----|---------------|------|---------|---------|---------|---------|
|     | THL              | THH | THM     | TSL | TSH              | TSM | DBL | DBH | DBM           | SGL  | HSCL/DY | HSHT/DY | SSCL/DY | SSHT/DY |
| JAN | 56               | 62  | 59 (55) |     |                  |     | 41  | 63  | 51            | 1108 | 0       | 0       |         |         |
| FEB | 56               | 64  | 60 (56) |     |                  |     | 38  | 66  | 52            | 1447 | 0       | 0       |         |         |
| MAR | 63               | 71  | 67 (62) |     |                  |     | 45  | 74  | 60            | 1889 | 0       | 0       |         |         |
| APR | 68               | 78  | 73 (67) |     |                  |     | 51  | 81  | 67            | 2401 | 0       | 0       |         |         |
| MAY | 71               | 83  | 78 (72) |     |                  |     | 56  | 88  | 74            | 2694 | 0       | 0       |         |         |
| JUN | 81               | 93  | 88 (81) |     |                  |     | 70  | 97  | 85            | 2721 | 0       | 0       |         |         |
| JUL | 84               | 94  | 88 (81) |     |                  |     | 75  | 97  | 85            | 2313 | 0       | 0       |         |         |
| AUG | 82               | 91  | 87 (80) |     |                  |     | 74  | 95  | 84            | 2193 | 0       | 0       |         |         |
| SEP | 78               | 87  | 83 (76) |     |                  |     | 70  | 90  | 80            | 1978 | 0       | 0       |         |         |
| OCT | 71               | 80  | 75 (69) |     |                  |     | 58  | 83  | 70            | 1654 | 0       | 0       |         |         |
| NOV | 63               | 70  | 67 (62) |     |                  |     | 47  | 70  | 58            | 1228 | 0       | 0       |         |         |
| DEC | 57               | 63  | 60 (55) |     |                  |     | 41  | 65  | 52            | 1034 | 0       | 0       |         |         |
| TOT | 69               | 78  | 74 (68) |     |                  |     | 56  | 81  | 68            | 1890 | 0       | 0       |         |         |

Note: CALPAS3 is the property of and is licensed by Berkeley Solar Group, 3140 Martin Luther King Jr. Way, Berkeley, CA 94703 (415 843-7600). Correct application and operation of CALPAS3 is the responsibility of the user. Actual building performance may deviate from CALPAS3 predictions due to differences between actual and assumed weather, construction, or occupancy. CALPAS3 is certified for California energy code compliance when used in accordance with the BSG publication "Using CALPAS3 with the California Residential Building Standards."

**RURAL ADOBE: UPSHAW 2 PORCH - NO VENTILATION**

UPSHW 1 BY: NEUMANN CALPAS3 V3.12 License: PC0201  
 TUCSON, AZ Weather: TUCSON.AZ (Tucson AZ ETMY)

\* Note: Graphs reflect adjusted temperatures for cooler climate  
 Sierra Vista AZ (higher elev.) vs. Tucson AZ  
 Sierra Vista Ave. DBT Oct.-March (winter) - 8% < Tucson  
 Sierra Vista Ave. DBT April-September (summer) - 7% < Tucson

MONTHLY HOUSE ENERGY BALANCE (kBtu; + into house)

| MON | GAINS & LOSSES |        |         |        |        |      | TRANSFERS |      |      |      |
|-----|----------------|--------|---------|--------|--------|------|-----------|------|------|------|
|     | COND           | SHCOND | INFIL   | SLR    | INT    | STRG | RB+SS     | VENT | COOL | HEAT |
| JAN | -1576.7        |        | -956.79 | 662.88 | 2116.1 | -237 |           |      | 0    | 0    |
| FEB | -1697.7        |        | -1000.2 | 719.13 | 1911.3 | 65.3 |           |      | 0    | 0    |
| MAR | -1687.4        |        | -1119.5 | 1087.7 | 2116.1 | -384 |           |      | 0    | 0    |
| APR | -1555.2        |        | -1108.8 | 1009.2 | 2047.8 | -381 |           |      | 0    | 0    |
| MAY | -1666.9        |        | -1173.9 | 893.48 | 2116.1 | -164 |           |      | 0    | 0    |
| JUN | -1504.2        |        | -1088.4 | 785.32 | 2047.8 | -233 |           |      | 0    | 0    |
| JUL | -1889.6        |        | -1158.5 | 624.15 | 2116.1 | 299  |           |      | 0    | 0    |
| AUG | -1417.7        |        | -1011.3 | 619.56 | 2116.1 | -298 |           |      | 0    | 0    |
| SEP | -1805.8        |        | -1088.9 | 522.79 | 2047.8 | 314  |           |      | 0    | 0    |
| OCT | -1779.2        |        | -1075.5 | 554.80 | 2116.1 | 178  |           |      | 0    | 0    |
| NOV | -2486.1        |        | -1270.6 | 928.51 | 2047.8 | 756  |           |      | 0    | 0    |
| DEC | -2024.8        |        | -1092.4 | 644.42 | 2116.1 | 344  |           |      | 0    | 0    |
| TOT | -21091         |        | -13145  | 9051.9 | 24915  | 260  |           |      | 0    | 0    |

MONTHLY CONDITIONS (Units as shown)

\* THM adjusted to right of THM w/ Tucson AZ Weather Files)

| MON | TEMPERATURES (F) |     |         |     | WTHR (F; Btu/sf) |     |     |     | PEAKS (kBtuh) |      |         |         |         |         |
|-----|------------------|-----|---------|-----|------------------|-----|-----|-----|---------------|------|---------|---------|---------|---------|
|     | THL              | THH | THM     | TSL | TSH              | TSM | DBL | DBH | DBM           | SGL  | HSCL/DY | HSHT/DY | SSCL/DY | SSHT/DY |
| JAN | 54               | 60  | 57 (52) |     |                  |     | 41  | 63  | 51            | 1108 | 0       | 0       |         |         |
| FEB | 55               | 62  | 59 (54) |     |                  |     | 38  | 66  | 52            | 1447 | 0       | 0       |         |         |
| MAR | 62               | 70  | 67 (61) |     |                  |     | 45  | 74  | 60            | 1889 | 0       | 0       |         |         |
| APR | 70               | 78  | 74 (68) |     |                  |     | 51  | 81  | 67            | 2401 | 0       | 0       |         |         |
| MAY | 77               | 85  | 81 (75) |     |                  |     | 56  | 88  | 74            | 2694 | 0       | 0       |         |         |
| JUN | 88               | 95  | 91 (84) |     |                  |     | 70  | 97  | 85            | 2721 | 0       | 0       |         |         |
| JUL | 90               | 96  | 93 (86) |     |                  |     | 75  | 97  | 85            | 2313 | 0       | 0       |         |         |
| AUG | 87               | 93  | 90 (83) |     |                  |     | 74  | 95  | 84            | 2193 | 0       | 0       |         |         |
| SEP | 84               | 89  | 87 (80) |     |                  |     | 70  | 90  | 80            | 1978 | 0       | 0       |         |         |
| OCT | 73               | 80  | 77 (71) |     |                  |     | 58  | 83  | 70            | 1654 | 0       | 0       |         |         |
| NOV | 63               | 69  | 66 (60) |     |                  |     | 47  | 70  | 58            | 1228 | 0       | 0       |         |         |
| DEC | 56               | 61  | 58 (53) |     |                  |     | 41  | 65  | 52            | 1034 | 0       | 0       |         |         |
| TOT | 72               | 78  | 75 (70) |     |                  |     | 56  | 81  | 68            | 1890 | 0       | 0       |         |         |

**RURAL ADOBE: UPSHAW 2 PORCH- NATURAL VENTILATION**

UPSHW 2 NAT VENT BY: NEUMANN CALPAS3 V3.12 License: PC0201  
 TUCSON, AZ Weather: TUCSON.AZ (Tucson AZ ETMY)

\* Note: Graphs reflect adjusted temperatures for cooler climate  
 Sierra Vista AZ (higher elev.) vs. Tucson AZ  
 Sierra Vista Ave. DBT Oct.-March (winter) - 8% < Tucson  
 Sierra Vista Ave. DBT April-September (summer) - 7% < Tucson

MONTHLY HOUSE ENERGY BALANCE (kBtu; + into house)

| MON | GAINS & LOSSES |       |         |        |        |      | TRANSFERS |      |      |      |
|-----|----------------|-------|---------|--------|--------|------|-----------|------|------|------|
|     | COND           | SHCND | INFIL   | SLR    | INT    | STRG | RB+SS     | VENT | COOL | HEAT |
| JAN | -1576.7        |       | -956.79 | 662.88 | 2116.1 | -237 |           | 0    | 0    | 0    |
| FEB | -1697.7        |       | -1000.2 | 719.13 | 1911.3 | 65.3 |           | 0    | 0    | 0    |
| MAR | -1657.2        |       | -1105.4 | 1087.7 | 2116.1 | -384 | -44.312   | 0    | 0    | 0    |
| APR | -998.86        |       | -845.24 | 1010.0 | 2047.8 | -292 | -915.38   | 0    | 0    | 0    |
| MAY | -131.19        |       | -460.77 | 894.05 | 2116.1 | -142 | -2271.1   | 0    | 0    | 0    |
| JUN | 142.87         |       | -324.27 | 785.32 | 2047.8 | -215 | -2429.4   | 0    | 0    | 0    |
| JUL | -136.76        |       | -346.60 | 624.15 | 2116.1 | 322  | -2589.3   | 0    | 0    | 0    |
| AUG | 105.43         |       | -309.94 | 619.56 | 2116.1 | -355 | -2164.3   | 0    | 0    | 0    |
| SEP | -152.02        |       | -323.82 | 522.79 | 2047.8 | 312  | -2416.4   | 0    | 0    | 0    |
| OCT | -864.20        |       | -655.57 | 554.87 | 2116.1 | 139  | -1294.7   | 0    | 0    | 0    |
| NOV | -2407.0        |       | -1237.1 | 928.51 | 2047.8 | 704  | -56.567   | 0    | 0    | 0    |
| DEC | -2024.8        |       | -1092.4 | 644.42 | 2116.1 | 344  | 0         | 0    | 0    | 0    |
| TOT | -11398         |       | -8658.0 | 9053.4 | 24915  | 260  | -14181    | 0    | 0    | 0    |

MONTHLY CONDITIONS (Units as shown)

\* THM adjusted to right of THM w/ Tucson AZ Weather Files)

| MON | TEMPERATURES (F) |     |         |     | WTHR (F; Btu/sf) |     |     |     | PEAKS (kBtuh) |      |         |         |         |         |
|-----|------------------|-----|---------|-----|------------------|-----|-----|-----|---------------|------|---------|---------|---------|---------|
|     | THL              | THH | THM     | TSL | TSH              | TSM | DBL | DBH | DBM           | SGL  | HSCL/DY | HSHT/DY | SSCL/DY | SSHT/DY |
| JAN | 54               | 60  | 57 (52) |     |                  |     | 41  | 63  | 51            | 1108 | 0       | 0       |         |         |
| FEB | 55               | 62  | 59 (54) |     |                  |     | 38  | 66  | 52            | 1447 | 0       | 0       |         |         |
| MAR | 62               | 70  | 66 (60) |     |                  |     | 45  | 74  | 60            | 1889 | 0       | 0       |         |         |
| APR | 68               | 77  | 72 (66) |     |                  |     | 51  | 81  | 67            | 2401 | 0       | 0       |         |         |
| MAY | 71               | 82  | 77 (71) |     |                  |     | 56  | 88  | 74            | 2694 | 0       | 0       |         |         |
| JUN | 80               | 91  | 87 (80) |     |                  |     | 70  | 97  | 85            | 2721 | 0       | 0       |         |         |
| JUL | 83               | 92  | 88 (81) |     |                  |     | 75  | 97  | 85            | 2313 | 0       | 0       |         |         |
| AUG | 81               | 90  | 86 (79) |     |                  |     | 74  | 95  | 84            | 2193 | 0       | 0       |         |         |
| SEP | 77               | 86  | 82 (75) |     |                  |     | 70  | 90  | 80            | 1978 | 0       | 0       |         |         |
| OCT | 70               | 78  | 74 (68) |     |                  |     | 58  | 83  | 70            | 1654 | 0       | 0       |         |         |
| NOV | 63               | 69  | 66 (61) |     |                  |     | 47  | 70  | 58            | 1228 | 0       | 0       |         |         |
| DEC | 56               | 61  | 58 (53) |     |                  |     | 41  | 65  | 52            | 1034 | 0       | 0       |         |         |
| TOT | 68               | 76  | 73 (68) |     |                  |     | 56  | 81  | 68            | 1890 | 0       | 0       |         |         |

**RURAL ADOBE: UPSHAW 3 ADDITION - NATURAL VENTILATION**

UPSHW 3 BY: NEUMANN CALPAS3 V3.12 License: PC0201  
 TUCSON, AZ Weather: TUCSON.AZ (Tucson AZ ETMY)

\* Note: Graphs reflect adjusted temperatures for cooler climate  
 Sierra Vista AZ (higher elev.) vs. Tucson AZ  
 Sierra Vista Ave. DBT Oct.-March (winter) - 8% < Tucson  
 Sierra Vista Ave. DBT April-September (summer) - 7% < Tucson

MONTHLY HOUSE ENERGY BALANCE (kBtu; + into house)

| MON | GAINS & LOSSES |       |         |        |        |      | TRANSFERS |      |      |      |
|-----|----------------|-------|---------|--------|--------|------|-----------|------|------|------|
|     | COND           | SHCND | INFIL   | SLR    | INT    | STRG | RB+SS     | VENT | COOL | HEAT |
| JAN | -1784.3        |       | -2224.4 | 2172.5 | 2116.1 | -268 |           | 0    | 0    | 0    |
| FEB | -1840.7        |       | -2294.8 | 2151.4 | 1911.3 | 69.4 |           | 0    | 0    | 0    |
| MAR | -1620.9        |       | -2418.2 | 2453.6 | 2116.1 | -469 | -39.854   | 0    | 0    | 0    |
| APR | -1075.1        |       | -2100.4 | 2432.0 | 2047.8 | -394 | -894.26   | 0    | 0    | 0    |
| MAY | -350.62        |       | -1563.6 | 2616.2 | 2116.1 | -172 | -2637.2   | 0    | 0    | 0    |
| JUN | 120.23         |       | -1108.1 | 2494.7 | 2047.8 | -242 | -3301.4   | 0    | 0    | 0    |
| JUL | -151.75        |       | -1109.8 | 2167.9 | 2116.1 | 421  | -3463.1   | 0    | 0    | 0    |
| AUG | 111.69         |       | -982.29 | 2121.6 | 2116.1 | -472 | -2873.0   | 0    | 0    | 0    |
| SEP | -251.25        |       | -1095.4 | 2163.8 | 2047.8 | 380  | -3262.8   | 0    | 0    | 0    |
| OCT | -1227.9        |       | -1908.8 | 2452.8 | 2116.1 | 149  | -1587.6   | 0    | 0    | 0    |
| NOV | -2487.5        |       | -2699.2 | 2220.5 | 2047.8 | 916  | -37.403   | 0    | 0    | 0    |
| DEC | -2192.8        |       | -2462.5 | 2130.8 | 2116.1 | 391  | 0         | 0    | 0    | 0    |
| TOT | -12751         |       | -21967  | 27578  | 24915  | 309  | -18097    | 0    | 0    | 0    |

MONTHLY CONDITIONS (Units as shown)

\* THM adjusted to right of THM w/ Tucson AZ Weather Files)

| MON | TEMPERATURES (F) |     |         |     | WTHR (F; Btu/sf) |     |     |     | PEAKS (kBtuh) |      |         |         |         |         |
|-----|------------------|-----|---------|-----|------------------|-----|-----|-----|---------------|------|---------|---------|---------|---------|
|     | THL              | THH | THM     | TSL | TSH              | TSM | DBL | DBH | DBM           | SGL  | HSCL/DY | HSHT/DY | SSCL/DY | SSHT/DY |
| JAN | 52               | 60  | 56 (52) |     |                  |     | 41  | 63  | 51            | 1108 | 0       | 0       |         |         |
| FEB | 51               | 62  | 57 (52) |     |                  |     | 38  | 66  | 52            | 1447 | 0       | 0       |         |         |
| MAR | 58               | 70  | 64 (59) |     |                  |     | 45  | 74  | 60            | 1889 | 0       | 0       |         |         |
| APR | 65               | 77  | 71 (65) |     |                  |     | 51  | 81  | 67            | 2401 | 0       | 0       |         |         |
| MAY | 70               | 83  | 77 (71) |     |                  |     | 56  | 88  | 74            | 2694 | 0       | 0       |         |         |
| JUN | 79               | 93  | 87 (80) |     |                  |     | 70  | 97  | 85            | 2721 | 0       | 0       |         |         |
| JUL | 82               | 93  | 88 (81) |     |                  |     | 75  | 97  | 85            | 2313 | 0       | 0       |         |         |
| AUG | 80               | 91  | 86 (79) |     |                  |     | 74  | 95  | 84            | 2193 | 0       | 0       |         |         |
| SEP | 76               | 87  | 82 (75) |     |                  |     | 70  | 90  | 80            | 1978 | 0       | 0       |         |         |
| OCT | 68               | 79  | 74 (68) |     |                  |     | 58  | 83  | 70            | 1654 | 0       | 0       |         |         |
| NOV | 59               | 68  | 63 (58) |     |                  |     | 47  | 70  | 58            | 1228 | 0       | 0       |         |         |
| DEC | 52               | 61  | 56 (52) |     |                  |     | 41  | 65  | 52            | 1034 | 0       | 0       |         |         |
| TOT | 66               | 77  | 72 (66) |     |                  |     | 56  | 81  | 68            | 1890 | 0       | 0       |         |         |

Note: CALPAS3 is the property of and is licensed by Berkeley Solar Group, 3140 Martin Luther King Jr. Way, Berkeley, CA 94703 (415 843-7600). Correct application and operation of CALPAS3 is the responsibility of the user. Actual building performance may deviate from CALPAS3 predictions due to differences between actual and assumed weather, construction, or occupancy. CALPAS3 is certified for California energy code compliance when used in accordance with the BSG publication "Using CALPAS3 with the California Residential Building Standards."





**U.S. Department of Housing and Urban Development**

Office of Policy Development and Research

Washington, DC 20410-6000

Official Business  
Penalty for Use \$300.00

Return Service Requested

**First-Class Mail**

Postage & Fees Paid

HUD Permit No. G-795

